



INGENUITY. PARTNERSHIP.  
INSPIRATION. THE FUTURE.



IT'S ALL IN  
HETTICH

Furniture Fittings &  
Architectural Hardware Price List  
effective March, 2024

Furniture  
Fittings  
Catalogue:



Architectural  
Hardware  
Catalogue:







Kirchlengern, Germany



Vadodara



Indore

Hettich is a 135 years old family owned German lifestyle brand, being one of the world's largest manufacturers of Furniture Fittings and Hardware with sales exceeding 1.5 billion Euros. It has presence in about 80 countries with over 8000 employees taking up the challenge of developing intelligent technology for furniture to create magical interior experiences for its customers.

In India, Hettich started operations with the dawn of the new millennium and within a short span of time gained undisputed leadership position in the Indian furniture fittings & hardware industry.

Hettich has state-of-the-art manufacturing capabilities globally including India, which enable it to manufacture world-class products both for the domestic and overseas markets. Its manufacturing facilities include three plants at Vadodara, Gujarat and one at Indore in Madhya Pradesh with another one in the pipeline. The company is firmly committed to the clarion call for Atmanirbhar Bharat by pursuing the philosophy of 'Make in India. Make for the World.'

## Brand Core Values

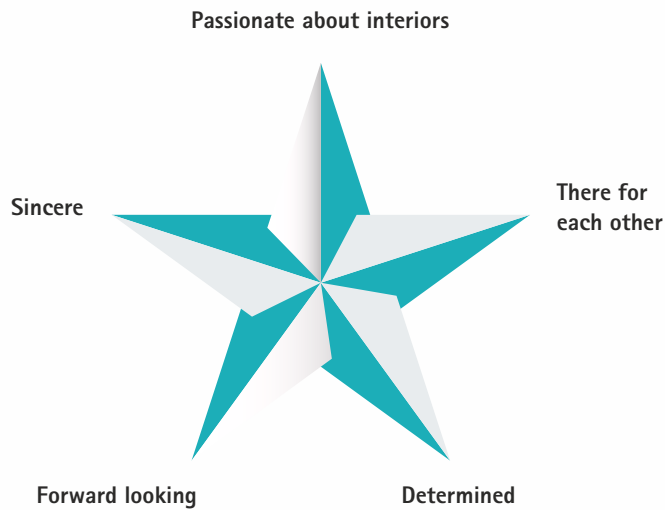

### Passionate about interiors

We apply all our skills and passion to develop complete and durable solutions for our customers. These bring rooms to life and fascinate people.

### There for each other

We create and maintain reliable partnerships with customers and colleagues. We put ourselves in their shoes, always give a little more than is expected and thereby achieve joint success.

### Determined

We are sensibly setting the course for an internationally successful future. To that end, we are bold in approaching challenges and act with courage and determination.

### Forward looking

We think across generations. Therefore, we consciously gear our present actions to the challenges of the future.

### Sincere

We are honest, down-to-earth and treat each other as equals. We rely on mutual trust and make a contribution to society.

## Certification & Standards





Loved by customers.  
Awarded by experts.



TopLine XL K2  
sliding door system



WingLine L with push/  
pull to move mechanism



SlideLine M  
sliding door system



AvanTech YOU  
drawer system



AvanTech YOU  
drawer system with lights



ArciTech  
drawer system



InnoTech Atira  
drawer system



Sensys hinge



FurnSpin  
swivel fitting



WIDE SCOPE AND QUALITY  
IN THE SMALLEST DETAIL.



IT'S ALL IN  
HETTICH



  
Hettich

Furniture Fittings	08
Hinges	08-12
Flap Fittings	13-15
Sliding & Folding Systems	16-34
Drawer Runners (Quadro, KA & FR)	35-38
Drawer System: AvanTech YOU	39-80
Drawer System: ArciTech	81-98
Drawer System: InnoTech Atira	99-108
Drawer System: InnoTech	109-119
New Kitchen Accessories	120
New Wardrobe Accessories	121-124
<b>Cargo Series</b>	<b>125-137</b>
CargoTech	126-127
CargoPlus	128
CargoTech M	129
<b>Connecting Fitting &amp; Locks</b>	<b>138-142</b>
<b>Handles</b>	<b>143-145</b>
<b>Aluminium Profiles</b>	<b>146-157</b>
<b>Shelving System: Cube PLUS</b>	<b>158-159</b>
<b>Magic Lights</b>	<b>160-166</b>

<b>Architectural Hardware</b>	<b>167</b>
Hinge Technology	168-169
Door Closer	170-171
Mortise Locking Solution	172-179
Panic Solution	180
ProLock Infinity Locking Solutions	181
Cylindrical Knob Sets	182
Floor Springs	182
Glass Patch Fittings	183
Pull Handles	184
Door Seals	185
Door Accessories	185-187
<b>Appendix</b>	<b>188-190</b>

\*Company reserves the right to change the products prices at any time without further notice.  
Company reserves the right to make changes & technical improvements to its products.



Sensys



Veosys



Onsys

## Hinges

The silent connection

Hinges from Hettich are the heart of good doors: innovative, reliable and long-lasting. They provide top quality, clever mounting and adjustment capabilities as well as provide solutions for both indoor & outdoor furniture. They have revolutionised the world of hinges with their invisibly integrated Silent System.

IT'S ALL IN HETTICH.



  
**Hettich**



# Auto Closing Concealed Hinges

► Slide On Hinges & Intermat Hinges



Product	Article No.	SAP	Item Description	Qty.	Unit	PU	MRP	HS Code
<b>Slide On Hinges</b>								
	<b>Slide On 2333 Hinge - T42 for 14-25 mm thick doors; Opening angle 95°</b>							
	9242867	9242867	Base 14.5 (Crank 0°) with Mounting Plate (D 1.5 mm)	1	Pair	100	110	83021090
	9242868	9242868	Base 5 (Crank 9.5°) with Mounting Plate (D 1.5 mm)	1	Pair	100	116	83021090
	9242869	9242869	Base -1.5 (Crank 16°) with Mounting Plate (D 1.5 mm)	1	Pair	100	120	83021090
<b>Accessories for Slide On Hinge</b>								
	9042758	9042758	Dampener for Hinge Cup overlay doors	1	Pc	100	179	83024200
<b>Intermat Hinges</b>								
	<b>Intermat 9936 Hinge - TH42 for 14-32 mm thick doors; Opening angle 95°</b>							
	9242874	9242874	Base 12.5 (Crank 0°) with Mounting Plate (D 0 mm)	1	Pair	100	304	83021090
	9242876	9242876	Base 3 (Crank 9.5°) with Mounting Plate (D 0 mm)	1	Pair	100	338	83021090
	9242877	9242877	Base -3.5 (Crank 16°) with Mounting Plate (D 0 mm)	1	Pair	100	372	83021090
	<b>Intermat 9935 Hinge - TH22/L for 16-43 mm thick doors; Opening angle 95°</b>							
	9242878	9242878	Base 18 (Crank -5°) with Mounting Plate (D 0 mm)	1	Pair	100	1,028	83021090
	9242883	9242883	Base 8 (Crank 5°) with Mounting Plate (D 0 mm)	1	Pair	100	1,060	83021090
	9242885	9242885	Base -3 (Crank 16°) with Mounting Plate (D 0 mm)	1	Pair	100	1,070	83021090
	<b>Intermat 9956 Hinge - TH42 16-24 mm thick doors; Opening angle 165°</b>							
9242890	9242890	Base 12.5 (Crank 0°) with Intermat Mounting plate	1	Pair	50	1,068	83021090	
	<b>Intermat 9930 Hinge - TH 52 16-21 mm thick doors; Opening angle 50/65°</b>							
	9243042	9243042	Corner unit folding door with Intermat Mounting Plate (D 0 mm); cup in sensys design	1	Pair	100	966	83021090
	9242888	9242888	Corner unit folding door with Intermat Mounting Plate (D 0 mm); cup in Intermat design	1	Pair	100	976	83021090
	<b>Intermat 9936 Hinge W90 - TH42 14-28 mm thick doors; face angle 90°, Opening angle 95°</b>							
	9242895	9242895	Blind corner (W 90°)	1	Pair	100	952	83021090

# Auto Closing Concealed Hinges

► Intermat Hinges, Onsys Hinges & Veosys Hinges



Product	Article No.	SAP	Item Description	Qty.	Unit	PU	MRP	HS Code
	<b>Intermat 9936 Hinge TA22 19 mm Aluminium Profile doors; Opening angle 95°</b>							
	9242896	9242896	Base 13.5 (Crank 0°) with Mounting Plate (D 0 mm)	1	Pair	10	578	83021090
	<b>Accessories for Intermat Hinge</b>							
	9302844	9302844	Intermat Cross Mounting Plate (System 9000) (D 0 mm)	1	Pc	100	24	83021000
	9214838	9214838	Sensys Cross Mounting Plate (System 8099) (D 0 mm)	1	Pc	100	32	83021090
	<b>Push to Open (P20) Opening System Screw on</b>							
	9051925	9051925	P20 Universal Maxi (For intermat & slide on hinges)	1	Set	25	462	39263000
	9089611	9089611	P20 Pin Strong for screwing on (For self closing hinges)	1	Set	25	632	39269097
<b>Onsys Hinge</b>								
	<b>Onsys 4447i Hinge - TH52 for 14-25 mm thick doors; Opening angle 105°</b>							
	9281432	9281432	Onsys Hinge - 25 mm - 0 Crank with mounting plate and cover caps	1	Pair	50	342	83021090
	9281434	9281434	Onsys Hinge - 25 mm - 9.5 Crank with mounting plate and cover caps	1	Pair	50	376	83021090
	9281436	9281436	Onsys Hinge - 25 mm - 16 Crank with mounting plate and cover caps	1	Pair	50	410	83021090
	<b>Onsys 4447 Hinge - TH52 for 14-25 mm thick doors; Opening angle 105° (Non Silent)</b>							
	9297208	9297208	Onsys Hinge - 25 mm - 0 Crank with mounting plate and cover caps	1	Pair	50	205	83021090
	9297209	9297209	Onsys Hinge - 25 mm - 9.5 Crank with mounting plate and cover caps	1	Pair	50	240	83021090
	9297210	9297210	Onsys Hinge - 25 mm - 16 Crank with mounting plate and cover caps	1	Pair	50	274	83021090
	<b>Onsys 4447i Hinge - TH52 for 14-25 mm thick doors; Opening angle 105° (Silent) with 4 Hole Mounting Plate</b>							
	9336570	9336570	Onsys Hinge - 25 mm - 0 Crank with 4 hole mounting plate and cover caps	1	Set	50	342	83021090
	9336591	9336591	Onsys Hinge - 25 mm - 9.5 Crank with 4 hole mounting plate and cover caps	1	Set	50	376	83021090
	9336592	9336592	Onsys Hinge - 25 mm - 16 Crank with 4 hole mounting plate and cover caps	1	Set	50	410	83021090
<b>Veosys Hinge</b>								
	<b>Veosys Hinge - TH52 for 14-22 mm thick doors; Opening angle 105°</b>							
	9315433	9315433	Base 11.5 (0 Crank) with mounting plate (D 0 mm) & cover cap	1	Pair	100	760	83021000
	9315434	9315434	Base 3 (9.5 Crank) with mounting plate (D 0 mm) & cover cap	1	Pair	100	790	83021000
	9315435	9315435	Base -6.5 (16 Crank) with mounting plate (D 0 mm) & cover cap	1	Pair	100	820	83021000
	<b>Accessories for Veosys Hinge</b>							
	9289598	9289598	Mounting Plate D 0.0	1	Pc	200	29	83021000
	9307265	9307265	Cover Cap embossed with Hettich logo	1	Pc	200	22	83024200

# Auto Closing Concealed Hinges

## ► Sensys Hinges



Product	Article No.	SAP	Item Description	Qty.	Unit	PU	MRP	HS Code
<b>Sensys Hinge</b>								
	<b>Sensys 8645i Hinge - TH52 for 15-24 mm thick doors; Opening angle 110°</b>							
	9242922	9242922	Base 12.5 (Crank 0°) with Mounting Plate (D 0 mm)	1	Pair	100	690	83021090
	9242923	9242923	Base 3 (Crank 9.5°) with Mounting Plate (D 0 mm)	1	Pair	100	728	83021090
	9242924	9242924	Base -4 (Crank 16°) with Mounting Plate (D 0 mm)	1	Pair	100	768	83021090
	<b>Sensys 8631i Hinge - TH52 for 15-32 mm thick doors; Opening angle 95°</b>							
	9242902	9242902	Base 12.5 (Crank 0°) with Mounting Plate (D 0 mm)	1	Pair	100	740	83021090
	9242905	9242905	Base 3 (Crank 9.5°) with Mounting Plate (D 0 mm)	1	Pair	100	780	83021090
	9242906	9242906	Base -4 (Crank 16°) with Mounting Plate (D 0 mm)	1	Pair	100	820	83021090
	<b>Sensys 8657i Hinge - TH52 for 15-32 mm thick doors; Opening angle 165° (Zero Protrusion Hinge)</b>							
	9243040	9243040	Base 12.5 (Crank 0°) with Mounting Plate (D 0 mm)	1	Pair	50	1,645	83021090
	<b>Sensys 8638i Hinge - TA32 for 19 mm Aluminium Profile; Opening angle 95°</b>							
	9243057	9243057	Base 12.5 (Crank 0°) with Mounting Plate (D 0 mm)	1	Pair	50	1,062	83021090
	<b>Sensys 8639i W90 Hinge - TH52 for 90° Face Angle Application; Opening angle 95°</b>							
	9243043	9243043	Base 4 (Crank 4) with Mounting Plate	1	Pair	50	1,550	83021090
	<b>Accessories of Sensys Hinge</b>							
	9199822	9199822	Sensys Cover Cap "Made in Germany"	1	Pc	50	16	83024200
	9082614	9082614	Sensys Cover Cap for Hinge Cup T52/53	1	Pc	50	20	83024200
	9214838	9214838	Sensys Mount Plate D 0	1	Pc	100	32	83021000
	9088242	9088242	Sensys Press-in Linear Mount Plate D 0.5	1	Pc	50	120	83021000
	46695	9246420	Door Buffer Self-Adhesive	1000	Pc	1,000	5,000	39269097
	1001097	1001097	T43 Hinge Screws (45169a)	100	Pc	5,000	300	73181558
	1058613	1058613	T43 Hinge Sockets 10mm Dia	100	Pc	10,000	500	39269097

# Auto Closing Concealed Hinges & Assorted Hinges

## ► Obsidian Black Sensys Hinges & Face Frame Hinges



Product	Article No.	SAP	Item Description	Qty.	Unit	PU	MRP	HS Code
<b>Obsidian Black Sensys Hinge</b>								
	<b>Obsidian Black Sensys 8645i Hinge - TH52 for 15-24 mm thick doors; Opening angle 110°</b>							
	9323480	9323480	Base 12.5 (Crank 0°) with Mounting Plate & cover cap	1	Pair	100	1,152	83021000
	9323561	9323561	Base 3 (Crank 9.5°) with Mounting Plate & cover cap	1	Pair	100	1,208	83021000
	9323562	9323562	Base -4 (Crank 16°) with Mounting Plate & cover cap	1	Pair	100	1,262	83021000
	<b>Obsidian Black Sensys 8631i Hinge - TH52 for 15-32 mm thick doors; Opening angle 95°</b>							
	9323563	9323563	Base 12.5 (Crank 0°) with Mounting Plate & cover cap	1	Pair	100	1,214	83021000
	9323564	9323564	Base 3 (Crank 9.5°) with Mounting Plate & cover cap	1	Pair	100	1,268	83021000
	9323565	9323565	Base -4 (Crank 16°) with Mounting Plate & cover cap	1	Pair	100	1,356	83021000
	<b>Obsidian Black Sensys 8657i Hinge-TH52 for 15-32 mm thick doors; Opening angle 165°(Zero Protrusion hinge)</b>							
	9091767	9091767	Base 12.5 (Crank 0°) (Order mounting plate separately)	1	Pc	50	1,057	83021000
	<b>Obsidian Black Sensys 8638i Hinge - TA32 for 19 mm Aluminium Profile, Opening Angle 95°</b>							
	9091744	9091744	Base 12.5 (Crank 0°) (Order mounting plate separately)	1	Pc	50	670	83021000
	<b>Obsidian Black Sensys 8639i W90 Hinge - TH52 for 90° Face Angle Application; Opening angle 95°</b>							
	9091748	9091748	Base 4 (Crank 4) (Order mounting plate separately)	1	Pc	50	941	83021000
	<b>Accessories of Sensys Hinge</b>							
	9091803	9091803	System 8099 Sensys Cross Mounting Plate with eccentric CAM D 0 mm in Black	1	Pc	50	108	83021000
	9308038	9308038	Sensys Screw-on Linear Mounting Plate with oblong CAM D 0.5 in Black	1	Pc	200	110	83021000
	9308181	9308181	Sensys Cover Cap for Hinge Arm in Black	1	Pc	200	20	83024200
	9308183	9308183	Sensys Cover Cap for Hinge Cup T52/53 in Black	1	Pc	200	26	83024200
	9308182	9308182	Sensys Cover Cap for Hinge Arm "Hettich" Black	1	Pc	200	20	83024200
<b>Assorted Hinges</b>								
	<b>Face Frame Hinge</b>							
	60832	9090098	Face frame hinge with spring system	1	Pc	10	813	83021000



# Flap Fittings

► Lift Advanced HF & Lift Advanced HK



Product	Article No.	SAP	Item Description	Qty.	Unit	PU	MRP	HS Code
---------	-------------	-----	------------------	------	------	----	-----	---------

## Lift Ups & Flap Stays



### Lift Advanced HF (Order Gas Spring Sets & Hinges Separately)

9079614*	9079614*	Lift Advanced HF (Inside Carcass Height 701-770 mm)	1	Set	1	9,325	83024900
9079615*	9079615*	Lift Advanced HF (Inside Carcass Height 771-925 mm)	1	Set	1	9,395	83024900
9079601*	9079601*	Lift Advanced HF 19mm Alu. Frame Adapter	1	Set	1	458	83024900

\*Available till stock last

## Gas Spring Sets for Lift Advanced HF

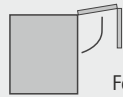

Folding flap fitting

Inside carcass height mm 450 - 550	Inside carcass height mm 551 - 610	Inside carcass height mm 611 - 700	Inside cabinet body height mm 701 - 770	Inside cabinet body height mm 771 - 925	Spring force N	Article No.	SAP	Unit	HS Code
4.4 - 5.8 kg	4.0 - 6.0 kg	-	-	-	300	9105888	9105888	Pc	83024200
5.1 - 6.6 kg	4.5 - 6.7 kg	3.8 - 5.8 kg	4.0 - 5.2 kg	-	350	9105889	9105889	Pc	83024200
6.0 - 8.0 kg	5.3 - 7.6 kg	4.6 - 7.0 kg	4.6 - 5.9 kg	4.0 - 5.5 kg	400	9105890	9105890	Pc	83024200
6.8 - 9.2 kg	6.2 - 8.6 kg	5.9 - 8.0 kg	5.3 - 6.7 kg	4.9 - 6.5 kg	450	9105891	9105891	Pc	83024200
7.8 - 10.2 kg	7.0 - 9.3 kg	6.9 - 8.9 kg	5.9 - 7.4 kg	5.5 - 7.0 kg	500	9105892	9105892	Pc	94039010
8.9 - 11.2 kg	8.0 - 10.3 kg	8.0 - 9.9 kg	6.7 - 8.3 kg	6.0 - 7.7 kg	550	9105895	9105895	Pc	83024200
10.5 - 12.6 kg	9.1 - 11.4 kg	8.8 - 10.8 kg	7.8 - 9.3 kg	6.9 - 8.7 kg	600	9105896	9105896	Pc	83024200
12.2 - 14.2 kg	10.5 - 12.6 kg	10.1 - 12.0 kg	8.5 - 10.4 kg	7.9 - 9.8 kg	650	9105897	9105897	Pc	83024200
13.2 - 15.0 kg	11.7 - 13.6 kg	11.1 - 12.9 kg	9.4 - 11.2 kg	8.7 - 10.5 kg	700	9079645	9079645	Set	83024200
13.8 - 15.4 kg	12.3 - 14.1 kg	11.6 - 13.5 kg	10.0 - 11.8 kg	9.3 - 11.0 kg	750	9079647	9079647	Set	83024200
-	13.3 - 14.6 kg	12.6 - 14.4 kg	10.8 - 12.7 kg	10.1 - 11.7 kg	800	9079650	9079650	Set	83024200



### Lift Advanced HK (Order Gas Spring Sets & Hinges Separately)

9079603*	9079603*	Lift Advanced HK (Inside Carcass Height 276 - 720 mm)	1	Set	1	7,335	83024900
9079709*	9079709*	Lift Advanced HK 19mm Alu. Frame Adapter	1	Set	1	616	83024200

\*Available till stock last

## Gas Spring Sets for Lift Advanced HK

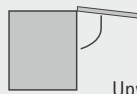

Upward opening flap fitting

Inside carcass height mm 276 - 360	Inside carcass height mm 361 - 480	Inside carcass height mm 481 - 540	Inside carcass height mm 541 - 600	Inside carcass height mm 601 - 720	Spring force N	Article No.	SAP	Unit	HS Code
2.1 - 4.7 kg *	2.0 - 3.8 kg	-	-	-	150	9079618	9079618	Set	83024200
4.1 - 7.0 kg *	3.3 - 5.4 kg	2.4 - 4.9 kg	-	-	200	9079619	9079619	Set	83024200
6.1 - 8.9 kg *	4.5 - 6.3 kg	3.8 - 6.2 kg	3.8 - 5.6 kg	3.8 - 5.0 kg	250	9105886	9105886	Pc	83024200
7.8 - 10.7 kg *	5.7 - 7.9 kg	5.2 - 7.6 kg	4.9 - 6.7 kg	4.4 - 5.9 kg	300	9105888	9105888	Pc	83024200
9.7 - 12.4 kg *	7.1 - 9.3 kg	6.6 - 9.0 kg	6.1 - 7.7 kg	5.4 - 6.8 kg	350	9105889	9105889	Pc	83024200
11.5 - 14.3 kg	8.6 - 10.7 kg	8.1 - 10.3 kg	7.2 - 8.8 kg	6.3 - 7.8 kg	400	9105890	9105890	Pc	83024200
13.3 - 16.0 kg	10.2 - 12.1 kg	9.7 - 11.6 kg	8.4 - 10.0 kg	7.3 - 8.7 kg	450	9105891	9105891	Pc	94039010
15.2 - 17.9 kg	11.7 - 13.4 kg	11.0 - 12.8 kg	9.6 - 11.0 kg	8.2 - 9.6 kg	500	9105892	9105892	Pc	83024200
-	12.9 - 14.3 kg	12.4 - 14.1 kg	10.7 - 12.2 kg	9.1 - 10.4 kg	550	9105895	9105895	Pc	83024200
-	14.2 - 15.5 kg	13.7 - 15.4 kg	12.0 - 13.2 kg	10.1 - 11.4 kg	600	9105896	9105896	Pc	83024200
-	15.4 - 16.8 kg	15.0 - 16.7 kg	13.1 - 14.3 kg	11.1 - 12.4 kg	650	9105897	9105897	Pc	83024200

# Flap Fittings

► Lift Advanced HL & Lift Advanced HS



Product	Article No.	SAP	Item Description	Qty.	Unit	PU	MRP	HS Code
	<b>Lift Advanced HL (Order Gas Spring Sets &amp; Hinges Separately)</b>							
	9079595*	9079595*	Lift Advanced HL (Inside Carcass Height 277-312 mm)	1	Set	1	8,995	83024900
	9079597*	9079597*	Lift Advanced HL (Inside Carcass Height 313-342 mm)	1	Set	1	9,127	83024900
	9079598*	9079598*	Lift Advanced HL (Inside Carcass Height 343-372 mm)	1	Set	1	9,243	83024900
	9079599*	9079599*	Lift Advanced HL (Inside Carcass Height 373-402 mm)	1	Set	1	9,442	83024900
	9079600*	9079600*	Lift Advanced HL (Inside Carcass Height 403-462 mm)	1	Set	1	9,356	83024900
	9079653*	9079653*	Lift Advanced Shortenable Rod 600	1	Set	1	1,050	83024900
	9079658*	9079658*	Lift Advanced Shortenable Rod 1200	1	Set	1	1,739	83024900
9079601*	9079601*	19mm Alu. Frame Adapter	1	Set	1	458	83024900	
<b>*Available till stock last</b>								

## Gas Spring Sets for Lift Advanced HL

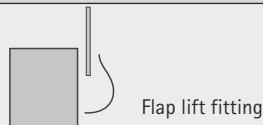

Inside carcass height mm 277 - 312	Inside carcass height mm 313 - 342	Inside carcass height mm 343 - 372	Inside carcass height mm 373 - 402	Inside carcass height mm 403 - 462	Spring force N	Article No.	SAP	Unit	HS Code
2.1 - 3.8 kg	2.3 - 3.8 kg	-	-	-	150	9079618	9079618	Set	83024200
3.8 - 5.4 kg	3.6 - 5.3 kg	2.1 - 4.8 kg	1.7 - 3.8 kg	-	200	9079619	9079619	Set	83024900
5.6 - 7.1 kg	5.2 - 7.1 kg	3.3 - 6.0 kg	2.6 - 5.0 kg	3.2 - 4.9 kg	250	9105886	9105886	Pc	83024900
7.3 - 8.8 kg	6.5 - 8.7 kg	4.3 - 7.2 kg	3.8 - 6.3 kg	4.4 - 5.9 kg	300	9105888	9105888	Pc	83024900
8.9 - 10.5 kg	7.9 - 10.2 kg	5.5 - 8.6 kg	4.9 - 7.5 kg	5.4 - 6.8 kg	350	9105889	9105889	Pc	83024900
10.6 - 12.1 kg	9.1 - 11.7 kg	6.6 - 9.7 kg	6.0 - 8.7 kg	6.3 - 7.8 kg	400	9105890	9105890	Pc	83024900
-	10.5 - 13.2 kg	7.8 - 10.9 kg	7.1 - 9.9 kg	7.3 - 8.7 kg	450	9105891	9105891	Pc	83024900
-	11.6 - 14.7 kg	8.9 - 12.2 kg	8.2 - 11.1 kg	8.2 - 9.6 kg	500	9105892	9105892	Pc	83024900
-	12.8 - 16.2 kg	10.0 - 13.4 kg	9.3 - 12.4 kg	9.1 - 10.4 kg	550	9105895	9105895	Pc	83024900
-	14.2 - 17.6 kg	11.2 - 14.6 kg	10.5 - 13.6 kg	10.1 - 11.4 kg	600	9105896	9105896	Pc	83024900
-	-	12.5 - 15.9 kg	11.7 - 14.9 kg	11.1 - 12.4 kg	650	9105897	9105897	Pc	83024900

	<b>Lift Advanced HS (Order Gas Spring Sets &amp; Hinges Separately)</b>							
	9079617*	9079617*	Lift Advanced HS (Inside Carcass Height 372-688 mm)	1	Set	1	8,988	83024200
	9079653*	9079653*	Lift Advanced Shortenable Rod 600	1	Set	1	1,050	83024900
	9079658*	9079658*	Lift Advanced Shortenable Rod 1200	1	Set	1	1,739	83024900
9079601*	9079601*	19mm Alu. Frame Adapter	1	Set	1	458	83024900	
<b>*Available till stock last</b>								

## Gas Spring Sets for Lift Advanced HS



Inside carcass height mm 372 - 408	Inside carcass height mm 409 - 508	Inside carcass height mm 509 - 568	Inside carcass height mm 569 - 688	Spring force N	Article No.	SAP	Unit	HS Code
3.0 - 4.4 kg	3.2 - 4.3 kg	2.5 - 3.9 kg	-	200	9079619	9079619	Set	83024200
4.0 - 5.4 kg	4.2 - 5.4 kg	3.4 - 5.2 kg	3.2 - 4.8 kg	250	9105886	9105886	Pc	83024200
5.3 - 6.7 kg	5.2 - 6.5 kg	4.4 - 6.4 kg	4.0 - 6.1 kg	300	9105888	9105888	Pc	83024200
6.3 - 7.9 kg	6.3 - 7.4 kg	5.4 - 7.4 kg	4.9 - 7.1 kg	350	9105889	9105889	Pc	83024200
7.7 - 9.1 kg	7.3 - 8.6 kg	6.5 - 8.4 kg	5.8 - 8.2 kg	400	9105890	9105890	Pc	83024200
8.8 - 10.3 kg	8.4 - 9.9 kg	7.5 - 9.5 kg	6.8 - 9.1 kg	450	9105891	9105891	Pc	83024200
10.0 - 11.5 kg	9.4 - 10.9 kg	8.6 - 10.5 kg	7.7 - 10.0 kg	500	9105892	9105892	Pc	94039010
11.0 - 12.6 kg	10.5 - 12.1 kg	9.6 - 11.6 kg	8.6 - 11.6 kg	550	9105895	9105895	Pc	83024200
12.1 - 13.8 kg	11.6 - 13.2 kg	10.7 - 12.6 kg	9.6 - 12.6 kg	600	9105896	9105896	Pc	83024200
13.3 - 14.9 kg	12.6 - 14.2 kg	11.7 - 13.7 kg	10.5 - 13.5 kg	650	9105897	9105897	Pc	83024200
	13.6 - 15.3 kg	12.8 - 14.7 kg	11.4 - 14.3 kg	700	9079645	9079645	Set	83024200

# Flap Fittings

► Gas Springs, Lift Up - Top Box Lift 90 & Flap Stay Lift Basic



Product	Article No.	SAP	Item Description	Qty.	Unit	PU	MRP	HS Code
<b>Gas Spring sets for Advanced Lift-Up (HF, HK, HL &amp; HS) (Order 2 pieces with 1 set of Advanced Lift-Up)</b>								
	9079618*	9079618*	Spring Force 150N	1	Set	1	4,466	83024200
	9079619*	9079619*	Spring Force 200N	1	Set	1	4,466	83024200
	9105886*	9105886*	Spring Force 250N	1	Pc	1	1,501	83024200
	9105888*	9105888*	Spring Force 300N	1	Pc	1	1,501	83024200
	9105889*	9105889*	Spring Force 350N	1	Pc	1	1,501	83024200
	9105890*	9105890*	Spring Force 400N	1	Pc	1	1,501	83024200
	9105891*	9105891*	Spring Force 450N	1	Pc	1	1,501	83024200
	9105892*	9105892*	Spring Force 500N	1	Pc	1	1,501	94039010
	9105895*	9105895*	Spring Force 550N	1	Pc	1	1,501	83024200
	9105896*	9105896*	Spring Force 600N	1	Pc	1	1,501	83024200
	9105897*	9105897*	Spring Force 650N	1	Pc	1	1,501	83024200
	9079645*	9079645*	Spring Force 700N	1	Set	1	4,466	83024200
	9079647*	9079647*	Spring Force 750N	1	Set	1	5,517	83024200
	9079650*	9079650*	Spring Force 800N	1	Set	1	5,517	83024200
	*Available till stock last							

<b>LiftEase Fitting (Order Hinges Separately only for Free Stop Versions)</b>								
	9347377	9347377	LiftEase-M (Medium) cabinet lift free stop - Black	1	Pc	1	1,750	83024200
	9347378	9347378	LiftEase-H (Heavy) cabinet lift free stop - Black	1	Pc	1	1,750	83024200
	9347381	9347381	LiftEase-M (Medium) -P20-Cabinet Lift - Black	1	Pc	1	1,800	83024200
	9347383	9347383	LiftEase-H (Heavy) -P20-Cabinet Lift - Black	1	Pc	1	1,800	83024200

<b>Lift Up - Top Box Lift 90 (Order Hinges Separately)</b>								
	10921 L	1077875	Flap Lift Exact 90 (4.6 kg) Left	1	Pc	30	640	83024200
	10921 R	1077876	Flap Lift Exact 90 (4.6 kg) Right	1	Pc	30	640	83024200

<b>Flap Stay Lift Basic (Order Hinge Separately)</b>								
	9079593	9079593	Lift Basic Flap Stay (3.2kg weight carrying capacity with 2 fittings ; Max Flap Dimensions: Width 600 mm Et Height 400 mm)	1	Pc	10	390	83024200





WingLine L



Grant 400 Neo



TopLine L-Loft Version

## Sliding & Folding Door Systems

Create more room in the room

Hettich Sliding & Folding Systems are designed to help you move wardrobe doors with effortless ease. Various sliding and folding door systems with different runner types provide solutions for different customer segments. It comes with a Silent System that provides luxuriously soft opening and closing.

IT'S ALL IN HETTICH.









# Sliding & Folding Systems

## ▶ TopLine XL K2



Product	Article No.	SAP	Item Description	Qty.	Unit	PU	MRP	HS Code
<b>Top Running Wardrobe Door Sliding Fittings</b>								
<b>TopLine XL K2</b>								
	<b>TopLine XL K2 – 2 Door for Wooden Doors 18-30 mm thickness; Weight 60 Kg per Door with Soft Closing &amp; Soft Opening; Max. Door Dimensions: Height-3000 mm &amp; Width-2000 mm</b>							
	9275788	9275788	Fitting Set for 2 door (18-30 mm Thickness) Door weight upto 60 Kg	1	Set	1	20,087	83024200
	9276737	9276737	Silent System for 2 door (60-100 kg)	1	Set	1	9,243	83024200
	9309712	9309712	Runner & Guide Profile 3600 mm with complete clip set	1	Set	1	19,900	83024200
	BOM Code	9320977	Total Set				49,230	
	<b>TopLine XL K2 – 2 Door for Wooden Doors 22-30 mm thickness; Weight 80 Kg per Door with Soft Closing &amp; Soft Opening; Max. Door Dimensions: Height-3000 mm &amp; Width-2000 mm</b>							
	9275790	9275790	Fitting Set for 2 door (22-30 mm Thickness) Door weight upto 80 Kg	1	Set	1	20,621	83024200
	9276737	9276737	Silent System for 2 door (60-100 kg)	1	Set	1	9,243	83024200
	9309712	9309712	Runner & Guide Profile 3600 mm with complete clip set	1	Set	1	19,900	83024200
	BOM Code	9320978	Total Set				49,764	
	<b>TopLine XL K2 – 2 Door for Wooden Doors 32-40 mm thickness; Weight 100 Kg per Door with Soft Closing &amp; Soft Opening; Max. Door Dimensions: Height-3000 mm &amp; Width-2000 mm</b>							
	9275708	9275708	Fitting Set for 2 door (32-40 mm Thickness) Door weight upto 100 Kg	1	Set	1	21,866	83024200
	9276737	9276737	Silent System for 2 door (60-100 kg)	1	Set	1	9,243	83024200
	9309712	9309712	Runner & Guide Profile 3600 mm with complete clip set	1	Set	1	19,900	83024200
	BOM Code	9320979	Total Set				51,009	
	<b>TopLine XL K2 – 3 Door for Wooden Doors 18-30 mm thickness; Weight 60 Kg per Door with Soft Closing &amp; Soft Opening; Max. Door Dimensions: Height-3000 mm &amp; Width-2000 mm</b>							
	9275781	9275781	Fitting Set for 3 door (18-30 mm Thickness) Door weight upto 60 Kg	1	Set	1	27,731	83024200
	9276646	9276646	Silent System for 3 door (60-100 kg)	1	Set	1	18,585	83024200
	9309712	9309712	Runner & Guide Profile 3600 mm with complete clip set	1	Set	1	19,900	83024200
	BOM Code	9320980	Total Set				66,216	
	<b>TopLine XL K2 – 3 Door for Wooden Doors 22-30 mm thickness; Weight 80 Kg per Door with Soft Closing &amp; Soft Opening; Max. Door Dimensions: Height-3000 mm &amp; Width-2000 mm</b>							
	9275709	9275709	Fitting Set for 3 door (22-30 mm Thickness) Door weight upto 80 Kg	1	Set	1	28,265	83024200
	9276646	9276646	Silent System for 3 door (60-100 kg)	1	Set	1	18,585	83024200
	9309712	9309712	Runner & Guide Profile 3600 mm with complete clip set	1	Set	1	19,900	83024200
	BOM Code	9320991	Total Set				66,750	

# Sliding & Folding Systems

## ▶ TopLine XL K2 & Accessories



Product	Article No.	SAP	Item Description	Qty.	Unit	PU	MRP	HS Code
	<b>TopLine XL K2 – 3 Door for Wooden Doors 32-40 mm thickness; Weight 100 Kg per Door with Soft Closing &amp; Soft Opening; Max. Door Dimensions: Height-3000 mm &amp; Width-2000 mm</b>							
	9275707	9275707	Fitting Set for 3 door (32-40 mm Thickness) Door weight upto 100 Kg	1	Set	1	29,687	83024200
	9276646	9276646	Silent System for 3 door (60-100 kg)	1	Set	1	18,585	83024200
	9309712	9309712	Runner & Guide Profile 3600 mm with complete clip set	1	Set	1	19,900	83024200
	BOM Code	9320992	Total Set				68,172	
	<b>TopLine XL K2 – 4 Door for Wooden Doors 18-30 mm thickness; Weight 60 Kg per Door with Soft Closing &amp; Soft Opening; Max. Door Dimensions: Height-3000 mm &amp; Width-2000 mm</b>							
	9278794	9278794	Fitting Set for 4 door (18-30 mm Thickness) Door weight upto 60 Kg	1	Set	1	40,174	83024200
	9278799	9278799	Silent System for 4 door (30-80 kg) (includes synchronization mechanism)	1	Set	1	26,354	83024200
	9309712	9309712	Runner & Guide Profile 3600 mm with complete clip set	1	Set	1	19,900	83024200
	BOM Code	9320993	Total Set				86,428	
	<b>TopLine XL K2 – 4 Door for Wooden Doors 22-30 mm thickness; Weight 80 Kg per Door with Soft Closing &amp; Soft Opening; Max. Door Dimensions: Height-3000 mm &amp; Width-2000 mm</b>							
	9278795	9278795	Fitting Set for 4 door (22-30 mm Thickness) Door weight upto 80 Kg	1	Set	1	41,242	83024200
	9278799	9278799	Silent System for 4 door (30-80 kg) (includes synchronization mechanism)	1	Set	1	26,354	83024200
	9309712	9309712	Runner & Guide Profile 3600 mm with complete clip set	1	Set	1	19,900	83024200
	BOM Code	9320994	Total Set				87,496	
	<b>Accessories</b>							
	9278801	9278801	Cover Profile 2000 mm Grey Finish	1	Pc	1	2,400	39169090



# Sliding & Folding Systems

## ▶ TopLine L Loft Version



Product	Article No.	SAP	Item Description	Qty.	Unit	PU	MRP	HS Code
<b>TopLine L Loft Version (With Wooden Door Thickness 16 – 25 mm / With 55 mm Aluminium Frame Door)</b>								
	<b>TopLine L Loft Version (2 Door Front Left 20 mm thickness) with STB 11 (Screw from bottom) – Weight 50 kg per door; Max. Door Dimensions: Height 2600 mm &amp; Width 550–2000 mm</b>							
	9344753	9344753	2 Door front left EB 32 for max. 20 mm thick door	1	Set	1	8,110	83024200
	9315109	9315109	Connecting pin for Runner profile	2	Pc	200	298	73170080
	9242229	9242229	Soft closing for 2 doors with 50-70 KG	1	Set	1	6,000	39263000
	9344941	9344941	Runner profile (Left 1500 mm + Right 1500 mm)	1	Set	1	4,000	76042990
	9288836	9288836	STB 11 Guide Profile 3000 mm	1	Set	1	2,276	76042990
	9340325	9340325	2 Door STB 11 Guide Kit	1	Set	1	2,315	83024200
			<b>Total Set</b>				<b>22,999</b>	
	<b>TopLine L Loft Version (2 Door Front Left 25 mm thickness) with STB 11 (Screw from bottom) – Weight 50 kg per door; Max. Door Dimensions: Height 2600 mm &amp; Width 550–2000 mm</b>							
	9344754	9344754	2 Door front left EB 36 for max. 25 mm thick door	1	Set	1	8,110	83024200
	9315109	9315109	Connecting pin for Runner profile	2	Pc	200	298	73170080
	9242229	9242229	Soft closing for 2 doors with 50-70 KG	1	Set	1	6,000	39263000
	9344941	9344941	Runner profile (Left 1500 mm + Right 1500 mm)	1	Set	1	4,000	76042990
	9288836	9288836	STB 11 Guide Profile 3000 mm	1	Set	1	2,276	76042990
	9340325	9340325	2 Door STB 11 Guide Kit	1	Set	1	2,315	83024200
			<b>Total Set</b>				<b>22,999</b>	
	<b>TopLine L Loft Version (2 Door Front Left 20 mm thickness) with STB 12 (Screw from front) – Weight 50 kg per door; Max. Door Dimensions: Height 2600 mm &amp; Width 550–2000 mm</b>							
	9344753	9344753	2 Door Front Left EB 32 for max. 20 mm thick door	1	Set	1	8,110	83024200
	9315109	9315109	Connecting pin for Runner profile	2	Pc	200	298	73170080
	9242229	9242229	Soft closing for 2 doors with 50-70 KG	1	Set	1	6,000	39263000
	9344941	9344941	Runner profile (Left 1500 mm + Right 1500 mm)	1	Set	1	4,000	76042990
	9288835	9288835	STB 12 Guide Profile 3000 mm	1	Set	1	2,276	76042990
	9325495	9325495	2 Door STB 12 Guide Kit	1	Set	1	2,315	83024200
			<b>Total Set</b>				<b>22,999</b>	
	<b>TopLine L Loft Version (2 Door Front Left 25 mm thickness) with STB 12 (Screw from front) – Weight 50 kg per door; Max. Door Dimensions: Height 2600 mm &amp; Width 550–2000 mm</b>							
	9344754	9344754	2 Door Front Left EB 36 for max. 25 mm thick door	1	Set	1	8,110	83024200
	9315109	9315109	Connecting pin for Runner profile	2	Pc	200	298	73170080
	9242229	9242229	Soft closing for 2 doors with 50-70 KG	1	Set	1	6,000	39263000
	9344941	9344941	Runner profile (Left 1500 mm + Right 1500 mm)	1	Set	1	4,000	76042990
	9288835	9288835	STB 12 Guide Profile 3000 mm	1	Set	1	2,276	76042990
	9325495	9325495	2 Door STB 12 Guide Kit	1	Set	1	2,315	83024200
			<b>Total Set</b>				<b>22,999</b>	
	<b>TopLine L Loft Version (2 Door Front Right 20 mm thickness) with STB 11 (Screw from bottom) – Weight 50 kg per door; Max. Door Dimensions: Height 2600 mm &amp; Width 550–2000 mm</b>							
	9333863	9333863	2 Door front right EB 32 for max. 20 mm thick door	1	Set	1	8,110	83024200
	9315109	9315109	Connecting pin for Runner profile	2	Pc	200	298	73170080
	9242229	9242229	Soft closing for 2 doors with 50-70 KG	1	Set	1	6,000	39263000
	9344941	9344941	Runner profile (Left 1500 mm + Right 1500 mm)	1	Set	1	4,000	76042990
	9288836	9288836	STB 11 Guide Profile 3000 mm	1	Set	1	2,276	76042990
	9340325	9340325	2 Door STB 11 Guide Kit	1	Set	1	2,315	83024200
			<b>Total Set</b>				<b>22,999</b>	



# Sliding & Folding Systems

## ▶ TopLine L Loft Version



Product	Article No.	SAP	Item Description	Qty.	Unit	PU	MRP	HS Code
---------	-------------	-----	------------------	------	------	----	-----	---------

### TopLine L Loft Version (With Wooden Door Thickness 16 - 25 mm / With 55 mm Aluminium Frame Door)



TopLine L Loft Version (2 Door Front Right 25 mm thickness) with STB 11 (Screw from bottom) - Weight 50 kg per door; Max. Door Dimensions: Height 2600 mm & Width 550-2000 mm

9333866	9333866	2 Door front right EB 36 for max. 25 mm thick door	1	Set	1	8,110	83024200	
9315109	9315109	Connecting pin for Runner profile	2	Pc	200	298	73170080	
9242229	9242229	Soft closing for 2 doors with 50-70 KG	1	Set	1	6,000	39263000	
9344941	9344941	Runner profile (Left 1500 mm + Right 1500 mm)	1	Set	1	4,000	76042990	
9288836	9288836	STB 11 Guide Profile 3000 mm	1	Set	1	2,276	76042990	
9340325	9340325	2 Door STB 11 Guide Kit	1	Set	1	2,315	83024200	
Total Set							22,999	



TopLine L Loft Version (2 Door Front Right 20 mm thickness) with STB 12 (Screw from front) - Weight 50 kg per door; Max. Door Dimensions: Height 2600 mm & Width 550-2000 mm

9333863	9333863	2 Door front right EB 32 for max. 20 mm thick door	1	Set	1	8,110	83024200	
9315109	9315109	Connecting pin for Runner profile	2	Pc	200	298	73170080	
9242229	9242229	Soft closing for 2 doors with 50-70 KG	1	Set	1	6,000	39263000	
9344941	9344941	Runner profile (Left 1500 mm + Right 1500 mm)	1	Set	1	4,000	76042990	
9288835	9288835	STB 12 Guide Profile 3000 mm	1	Set	1	2,276	76042990	
9325495	9325495	2 Door STB 12 Guide Kit	1	Set	1z	2,315	83024200	
Total Set							22,999	



TopLine L Loft Version (2 Door Front Right 25 mm thickness) with STB 12 (Screw from front) - Weight 50 kg per door; Max. Door Dimensions: Height 2600 mm & Width 550-2000 mm

9333866	9333866	2 Door front right EB 36 for max. 25 mm thick door	1	Set	1	8,110	83024200	
9315109	9315109	Connecting pin for Runner profile	2	Pc	200	298	73170080	
9242229	9242229	Soft closing for 2 doors with 50-70 KG	1	Set	1	6,000	39263000	
9344941	9344941	Runner profile (Left 1500 mm + Right 1500 mm)	1	Set	1	4,000	76042990	
9288835	9288835	STB 12 Guide Profile 3000 mm	1	Set	1	2,276	76042990	
9325495	9325495	2 Door STB 12 Guide Kit	1	Set	1	2,315	83024200	
Total Set							22,999	



TopLine L Loft Version (3 Door 20 mm thickness) with STB 11 (Screw from bottom) - Weight 50 kg per door; Max. Door Dimensions: Height 2600 mm & Width 550-2000 mm

9333864	9333864	3 Door EB 32 for max. 20 mm thick door	1	Set	1	11,042	83024200	
9315109	9315109	Connecting pin for Runner profile	2	Pc	200	298	73170080	
9242230	9242230	Soft closing for 3 doors with 50-70 KG	1	Set	1	10,500	39263000	
9344941	9344941	Runner profile (Left 1500 mm + Right 1500 mm)	1	Set	1	4,000	76042990	
9288836	9288836	STB 11 Guide Profile 3000 mm	1	Set	1	2,276	76042990	
9323046	9323046	3 Door STB 11 Guide Kit	1	Set	1	2,583	83024200	
Total Set							30,699	



TopLine L Loft Version (3 Door 25 mm thickness) with STB 11 (Screw from bottom) - Weight 50 kg per door; Max. Door Dimensions: Height 2600 mm & Width 550-2000 mm

9333865	9333865	3 Door EB 36 for max. 25 mm thick door	1	Set	1	11,042	83024200	
9315109	9315109	Connecting pin for Runner profile	2	Pc	200	298	73170080	
9242230	9242230	Soft closing for 3 doors with 50-70 KG	1	Set	1	10,500	39263000	
9344941	9344941	Runner profile (Left 1500 mm + Right 1500 mm)	1	Set	1	4,000	76042990	
9288836	9288836	STB 11 Guide Profile 3000 mm	1	Set	1	2,276	76042990	
9323046	9323046	3 Door STB 11 Guide Kit	1	Set	1	2,583	83024200	
Total Set							30,699	



# Sliding & Folding Systems

## ► TopLine L Loft Version



Product	Article No.	SAP	Item Description	Qty.	Unit	PU	MRP	HS Code
<b>TopLine L Loft Version (With Wooden Door Thickness 16 – 25 mm / With 55 mm Aluminium Frame Door)</b>								
	<b>TopLine L Loft Version (3 Door 20 mm thickness) with STB 12 (Screw from front) – Weight 50 kg per door; Max. Door Dimensions: Height 2600 mm &amp; Width 550-2000 mm</b>							
	9333864	9333864	3 Door EB 32 for max. 20 mm thick door	1	Set	1	11,042	83024200
	9315109	9315109	Connecting pin for Runner profile	2	Pc	200	298	73170080
	9242230	9242230	Soft closing for 3 doors with 50-70 KG	1	Set	1	10,500	39263000
	9344941	9344941	Runner profile (Left 1500 mm + Right 1500 mm)	1	Set	1	4,000	76042990
	9288835	9288835	STB 12 Guide Profile 3000 mm	1	Set	1	2,276	76042990
	45083	45083	3 Door STB 12 Guide Kit	1	Set	1	2,583	83024200
			<b>Total Set</b>				<b>30,699</b>	
	<b>TopLine L Loft Version (3 Door 25 mm thickness) with STB 12 (Screw from front) – Weight 50 kg per door; Max. Door Dimensions: Height 2600 mm &amp; Width 550-2000 mm</b>							
	9333865	9333865	3 Door EB 36 for max. 25 mm thick door	1	Set	1	11,042	83024200
	9315109	9315109	Connecting pin for Runner profile	2	Pc	200	298	73170080
	9242230	9242230	Soft closing for 3 doors with 50-70 KG	1	Set	1	10,500	39263000
	9344941	9344941	Runner profile (Left 1500 mm + Right 1500 mm)	1	Set	1	4,000	76042990
	9288835	9288835	STB 12 Guide Profile 3000 mm	1	Set	1	2,276	76042990
	45083	45083	3 Door STB 12 Guide Kit	1	Set	1	2,583	83024200
			<b>Total Set</b>				<b>30,699</b>	
	<b>TopLine L Loft Version : Silent System Soft Opening, Soft Colliding &amp; Cover Profile</b>							
	9242227	9242227	Silent system Soft opening for 2 door weight upto 50 kg	1	Set	1	6,000	83024200
	9242228	9242228	Silent system Soft opening for 3 door weight upto 50 kg	1	Set	1	10,700	83024200
	9254630	9254630	Soft colliding for the rear most doors of 3 door sliding door cabinets	1	Set	1	1,370	83024200
	9277440	9277440	Cover Profile 1500 mm Grey Finish	1	Pc	1	800	39169090

# Sliding & Folding Systems

## ▶ TopLine L







Product	Article No.	SAP	Item Description	Qty.	Unit	PU	MRP	HS Code
<b>TopLine L (With Wooden Door Thickness 18–30 mm)</b>								
	<b>TopLine L (2 Door Front Left 18–30 mm thickness) with STB 11 (Screw from bottom) – Weight 50 kg per door; Max. Door Dimensions: Height 2600 mm &amp; Width 550–1500 mm</b>							
	9322660	9322660	TLL 2 Door Left 18–30 mm Wooden Runner kit	1	Set	1	7,685	83024200
	9340325	9340325	STB 11 Guide kit for 2 Doors	1	Set	1	2,315	83024200
	9242238	9242238	Silent system Soft Closing for 2 door weight upto 50 kg	1	Set	1	6,000	83024200
	9306367	9306367	3000 mm Runner profile and Guide Profile (screw from bottom)	1	Set	2	4,900	83024200
			<b>Total Set</b>				<b>20,900</b>	
	<b>TopLine L (2 Door Front Left 18–30 mm thickness) with STB 11 (Screw from top) – Weight 50 kg per door; Max. Door Dimensions: Height 2600 mm &amp; Width 550–1500 mm</b>							
	9322660	9322660	TL L 2 Door Left 18–30 mm Wooden Runner kit	1	Set	1	7,685	83024200
	9340325	9340325	STB 11 Guide kit for 2 Doors	1	Set	1	2,315	83024200
	9242238	9242238	Silent system Soft Closing for 2 door weight upto 50 kg	1	Set	1	6,000	83024200
	9315516	9315516	3000 mm Runner profile and Guide Profile (STB 11 Screw from top)	1	Set	2	4,900	83024200
			<b>Total Set</b>				<b>20,900</b>	
	<b>TopLine L (2 Door Front Left 18–30 mm thickness) with STB 12 (Screw from front) – Weight 50 kg per door; Max. Door Dimensions: Height 2600 mm &amp; Width 550–1500 mm</b>							
	9322660	9322660	TL L 2 Door Left 18–30 mm Wooden Runner kit	1	Set	1	7,685	83024200
	9325495	9325495	STB 12 Guide kit for 2 Doors	1	Set	1	2,315	83024200
	9242238	9242238	Silent system Soft Closing for 2 door weight upto 50 kg	1	Set	1	6,000	83024200
	9315199	9315199	3000 mm Runner profile and Guide Profile (STB 12 Screw from front)	1	Set	2	4,900	83024200
			<b>Total Set</b>				<b>20,900</b>	
	<b>TopLine L (2 Door Front Right 18–30 mm thickness) with STB 11 (Screw from bottom) – Weight 50 kg per door; Max. Door Dimensions: Height 2600 mm &amp; Width 550–1500 mm</b>							
	9322675	9322675	TL L 2 Door Right 18–30 mm Wooden Runner kit	1	Set	1	7,685	83024200
	9340325	9340325	STB 11 Guide kit for 2 Doors	1	Set	1	2,315	83024200
	9242238	9242238	Silent system Soft Closing for 2 door weight upto 50 kg	1	Set	1	6,000	83024200
	9306367	9306367	3000 mm Runner profile and Guide Profile (screw from bottom)	1	Set	2	4,900	83024200
			<b>Total Set</b>				<b>20,900</b>	
	<b>TopLine L (2 Door Front Right 18–30 mm thickness) with STB 11 (Screw from top) – Weight 50 kg per door; Max. Door Dimensions: Height 2600 mm &amp; Width 550–1500 mm</b>							
	9322675	9322675	TL L 2 Door Right 18–30 mm Wooden Runner kit	1	Set	1	7,685	83024200
	9340325	9340325	STB 11 Guide kit for 2 Doors	1	Set	1	2,315	83024200
	9242238	9242238	Silent system Soft Closing for 2 door weight upto 50 kg	1	Set	1	6,000	83024200
	9315516	9315516	3000 mm Runner profile and Guide Profile (STB 11 Screw from top)	1	Set	2	4,900	83024200
			<b>Total Set</b>				<b>20,900</b>	

# Sliding & Folding Systems

## ▶ TopLine L



Product	Article No.	SAP	Item Description	Qty.	Unit	PU	MRP	HS Code
	<b>TopLine L (2 Door Front Right 18–30 mm thickness) with STB 12 (Screw from front) – Weight 50 kg per door; Max. Door Dimensions: Height 2600 mm &amp; Width 550–1500 mm</b>							
	9322675	9322675	TL L 2 Door Right 18–30 mm Wooden Runner kit	1	Set	1	7,685	83024200
	9325495	9325495	STB 12 Guide kit for 2 Doors	1	Set	1	2,315	83024200
	9242238	9242238	Silent system Soft Closing for 2 door weight upto 50 kg	1	Set	1	6,000	83024200
	9315199	9315199	3000 mm Runner profile and Guide Profile (STB 12 Screw from front)	1	Set	2	4,900	83024200
			<b>Total Set</b>				<b>20,900</b>	
	<b>TopLine L (3 Door 18–30 mm thickness) with STB 11 (Screw from bottom) – Weight 50 kg per door; Max. Door Dimensions: Height 2600 mm &amp; Width 550–1500 mm</b>							
	9322659	9322659	TL L 3 Door 18–30 mm Wooden Runner kit	1	Set	1	9,781	83024200
	9323046	9323046	STB 11 Guide kit for 3 Doors	1	Set	1	2,519	83024200
	9242240	9242240	Silent system Soft Closing for 3 door weight upto 50 kg	1	Set	1	10,700	83024200
	9306367	9306367	3000 mm Runner profile and Guide Profile (screw from bottom)	1	Set	2	4,900	83024200
			<b>Total Set</b>				<b>27,900</b>	
	<b>TopLine L (3 Door 18–30 mm thickness) with STB 11 (Screw from top) – Weight 50 kg per door; Max. Door Dimensions: Height 2600 mm &amp; Width 550–1500 mm</b>							
	9322659	9322659	TL L 3 Door 18–30 mm Wooden Runner kit	1	Set	1	9,781	83024200
	9323046	9323046	STB 11 Guide kit for 3 Doors	1	Set	1	2,519	83024200
	9242240	9242240	Silent system Soft Closing for 3 door weight upto 50 kg	1	Set	1	10,700	83024200
	9315516	9315516	3000 mm Runner profile and Guide Profile (STB 11 Screw from top)	1	Set	2	4,900	83024200
			<b>Total Set</b>				<b>27,900</b>	
	<b>TopLine L (3 Door 18–30 mm thickness) with STB 12 (Screw from front) – Weight 50 kg per door; Max. Door Dimensions: Height 2600 mm &amp; Width 550–1500 mm</b>							
	9322659	9322659	TL L 3 Door 18–30 mm Wooden Runner kit	1	Set	1	9,781	83024200
	45083	45083	STB 12 Guide kit for 3 Doors	1	Set	1	2,583	83024200
	9242240	9242240	Silent system Soft Closing for 3 door weight upto 50 kg	1	Set	1	10,700	83024200
	9315199	9315199	3000 mm Runner profile and Guide Profile (STB 12 Screw from front)	1	Set	2	4,900	83024200
			<b>Total Set</b>				<b>27,964</b>	
<b>TopLine L (With Aluminium Door Thickness 18–30 mm with 55 mm Aluminium Frame Door)</b>								
	<b>TopLine L (2 Door Front Left 18–30 mm thickness) with STB 11 (Screw from bottom) – Weight 50 kg per door; Max. Door Dimensions: Height 2600 mm &amp; Width 550–1500 mm</b>							
	9322696	9322696	TL L 2 Door Left 18–30 mm Aluminium runner kit	1	Set	1	10,615	83024200
	9340325	9340325	STB 11 Guide kit for 2 Doors	1	Set	1	2,315	83024200
	9242238	9242238	Silent system Soft Closing for 2 door weight upto 50 kg	1	Set	1	6,000	83024200
	9306367	9306367	3000 mm Runner profile and Guide Profile (screw from bottom)	1	Set	2	4,900	83024200
			<b>Total Set</b>				<b>23,830</b>	

# Sliding & Folding Systems

## ► TopLine L



Product	Article No.	SAP	Item Description	Qty.	Unit	PU	MRP	HS Code
	<b>TopLine L (2 Door Front Left 18-30 mm thickness) with STB 11 (Screw from top) - Weight 50 kg per door; Max. Door Dimensions: Height 2600 mm &amp; Width 550-1500 mm</b>							
	9322696	9322696	TL L 2 Door Left 18-30 mm Aluminium runner kit	1	Set	1	10,615	83024200
	9340325	9340325	STB 11 Guide kit for 2 Doors	1	Set	1	2,315	83024200
	9242238	9242238	Silent system Soft Closing for 2 door weight upto 50 kg	1	Set	1	6,000	83024200
	9315516	9315516	3000 mm Runner profile and Guide Profile (STB 11 Screw from top)	1	Set	2	4,900	83024200
			<b>Total Set</b>				<b>23,830</b>	
	<b>TopLine L (2 Door Front Left 18-30 mm thickness) with STB 12 (Screw from front) - Weight 50 kg per door; Max. Door Dimensions: Height 2600 mm &amp; Width 550-1500 mm</b>							
	9322696	9322696	TL L 2 Door Left 18-30 mm Aluminium runner kit	1	Set	1	10,615	83024200
	9325495	9325495	STB 12 Guide kit for 2 Doors	1	Set	1	2,315	83024200
	9242238	9242238	Silent system Soft Closing for 3 door weight upto 50 kg	1	Set	1	6,000	83024200
	9315199	9315199	3000 mm Runner profile and Guide Profile (screw from bottom)	1	Set	2	4,900	83024200
			<b>Total Set</b>				<b>23,830</b>	
	<b>TopLine L (2 Door Front Right 18-30 mm thickness) with STB 11 (Screw from bottom) - Weight 50 kg per door; Max. Door Dimensions: Height 2600 mm &amp; Width 550-1500 mm</b>							
	9322694	9322694	TL L 2 Door Right 18-30 mm Aluminium runner kit	1	Set	1	10,615	83024200
	9340325	9340325	STB 11 Guide kit for 2 Doors	1	Set	1	2,315	83024200
	9242238	9242238	Silent system Soft Closing for 2 door weight upto 50 kg	1	Set	1	6,000	83024200
	9306367	9306367	3000 mm Runner profile and Guide Profile (screw from bottom)	1	Set	2	4,900	83024200
			<b>Total Set</b>				<b>23,830</b>	
	<b>TopLine L (2 Door Front Right 18-30 mm thickness) with STB 11 (Screw from top) - Weight 50 kg per door; Max. Door Dimensions: Height 2600 mm &amp; Width 550-1500 mm</b>							
	9322694	9322694	TL L 2 Door Right 18-30 mm Aluminium runner kit	1	Set	1	10,615	83024200
	9340325	9340325	STB 11 Guide kit for 2 Doors	1	Set	1	2,315	83024200
	9242238	9242238	Silent system Soft Closing for 2 door weight upto 50 kg	1	Set	1	6,000	83024200
	9315516	9315516	3000 mm Runner profile and Guide Profile (STB 11 Screw from top)	1	Set	2	4,900	83024200
			<b>Total Set</b>				<b>23,830</b>	
	<b>TopLine L (2 Door Front Right 18-30 mm thickness) with STB 12 (Screw from front) - Weight 50 kg per door; Max. Door Dimensions: Height 2600 mm &amp; Width 550-1500 mm</b>							
	9322694	9322694	TL L 2 Door Right 18-30 mm Aluminium runner kit	1	Set	1	10,615	83024200
	9325495	9325495	STB 12 Guide kit for 2 Doors	1	Set	1	2,315	83024200
	9242238	9242238	Silent system Soft Closing for 2 door weight upto 50 kg	1	Set	1	6,000	83024200
	9315199	9315199	3000 mm Runner profile and Guide Profile (STB 12 Screw from front)	1	Set	2	4,900	83024200
			<b>Total Set</b>				<b>23,830</b>	



# Sliding & Folding Systems

## ▶ TopLine L



Product	Article No.	SAP	Item Description	Qty.	Unit	PU	MRP	HS Code
	<b>TopLine L (3 Door 18-30 mm thickness) with STB 11 (Screw from bottom) – Weight 50 kg per door; Max. Door Dimensions: Height 2600 mm &amp; Width 550-1500 mm</b>							
	9322697	9322697	TL L 3 Door 18-30 mm Aluminium runner kit	1	Set	1	14,801	83024200
	9323046	9323046	STB 11 Guide kit for 3 Doors	1	Set	1	2,519	83024200
	9242240	9242240	Silent system Soft Closing for 3 door weight upto 50 kg	1	Set	1	10,700	83024200
	9306367	9306367	3000 mm Runner profile and Guide Profile (screw from bottom)	1	Set	2	4,900	83024200
			<b>Total Set</b>				<b>32,920</b>	

	<b>TopLine L (3 Door 18-30 mm thickness) with STB 11 (Screw from top) – Weight 50 kg per door; Max. Door Dimensions: Height 2600 mm &amp; Width 550-1500 mm</b>							
	9322697	9322697	TL L 3 Door 18-30 mm Aluminium runner kit	1	Set	1	14,801	83024200
	9323046	9323046	STB 11 Guide kit for 3 Doors	1	Set	1	2,519	83024200
	9242240	9242240	Silent system Soft Closing for 3 door weight upto 50 kg	1	Set	1	10,700	83024200
	9315516	9315516	3000 mm Runner profile and Guide Profile (STB 11 Screw from top)	1	Set	2	4,900	83024200
			<b>Total Set</b>				<b>32,920</b>	

	<b>TopLine L (3 Door 18-30 mm thickness) with STB 12 (Screw from front) – Weight 50 kg per door; Max. Door Dimensions: Height 2600 mm &amp; Width 550-1500 mm</b>							
	9322697	9322697	TL L 3 Door 18-30 mm Aluminium runner kit	1	Set	1	14,801	83024200
	45083	45083	STB 12 Guide kit for 3 Doors	1	Set	1	2,583	83024200
	9242240	9242240	Silent system Soft Closing for 3 door weight upto 50 kg	1	Set	1	10,700	83024200
	9315199	9315199	3000 mm Runner profile and Guide Profile (STB 12 Screw from front)	1	Set	2	4,900	83024200
			<b>Total Set</b>				<b>32,984</b>	

### TopLine L (With Wooden Door Thickness 35-50 mm)

	<b>TopLine L: 2 Door Right for Wooden Doors 35-50 mm thickness – Weight 50 kg per door; Max. Door Dimensions: Height 2600 mm &amp; Width 550-1500 mm</b>							
	9242715	9242715	2 Door right - Runner Set, Guide set & Fixing material for Door thickness of 35-50 mm for door weight upto 50 kg	1	Set	1	10,300	83024200
	9242238	9242238	Silent system Soft Closing for 2 door weight upto 50 kg	1	Set	1	6,000	83024200
	9306367	9306367	3000 mm Runner profile and Guide Profile (screw from bottom)	1	Set	2	4,900	83024200
	BOM Code	9320997	<b>Total Set</b>				<b>21,200</b>	

	<b>TopLine L: 2 Door Left for Wooden Doors 35-50 mm thickness – Weight 50 kg per door; Max. Door Dimensions: Height 2600 mm &amp; Width 550-1500 mm</b>							
	9242714	9242714	2 Door left - Runner Set, Guide set & Fixing material for Door thickness of 35-50 mm for door weight upto 50 kg	1	Set	1	10,300	83024200
	9242238	9242238	Silent system Soft Closing for 2 door weight upto 50 kg	1	Set	1	6,000	83024200
	9306367	9306367	3000 mm Runner profile and Guide Profile (screw from bottom)	1	Set	2	4,900	83024200
	BOM Code	9320998	<b>Total Set</b>				<b>21,200</b>	

# Sliding & Folding Systems

## ▶ TopLine L



Product	Article No.	SAP	Item Description	Qty.	Unit	PU	MRP	HS Code
	<b>TopLine L: 3 Door for Wooden Doors 35-50 mm thickness - Weight 50 kg per door; Max. Door Dimensions: Height 2600 mm &amp; Width 550-1500 mm</b>							
	9242718	9242718	3 Door Runner Set, Guide set & Fixing material for Door thickness of 35-50 mm for door weight upto 50 kg	1	Set	1	12,600	83024200
	9242240	9242240	Silent system Soft Closing for 3 door weight upto 50 kg	1	Set	1	10,700	83024200
	9306367	9306367	3000 mm Runner profile and Guide Profile (screw from bottom)	1	Set	2	4,900	83024200
	BOM Code	9321005	Total Set				28,200	
	<b>TopLine L: 2 Door Right for Wooden Doors 35-50 mm thickness - Weight 50 kg per door; Max. Door Dimensions: Height 2600 mm &amp; Width 550-1500 mm</b>							
	9242715	9242715	2 Door right - Runner Set, Guide set & Fixing material for Door thickness of 35-50 mm for door weight upto 50 kg	1	Set	1	10,300	83024200
	9242238	9242238	Silent system Soft Closing for 2 door weight upto 50 kg	1	Set	1	6,000	83024200
	9315516	9315516	3000 mm Runner profile and Guide Profile (STB 11 Screw from top)	1	Set	2	4,900	83024200
	BOM Code	9321026	Total Set				21,200	
	<b>TopLine L: 2 Door Left for Wooden Doors 35-50 mm thickness - Weight 50 kg per door; Max. Door Dimensions: Height 2600 mm &amp; Width 550-1500 mm</b>							
	9242714	9242714	2 Door left - Runner Set, Guide set & Fixing material for Door thickness of 35-50 mm for door weight upto 50 kg	1	Set	1	10,300	83024200
	9242238	9242238	Silent system Soft Closing for 2 door weight upto 50 kg	1	Set	1	6,000	83024200
	9315516	9315516	3000 mm Runner profile and Guide Profile (STB 11 Screw from top)	1	Set	2	4,900	83024200
	BOM Code	9321027	Total Set				21,200	
	<b>TopLine L: 3 Door for Wooden Doors 35-50 mm thickness - Weight 50 kg per door; Max. Door Dimensions: Height 2600 mm &amp; Width 550-1500 mm</b>							
	9242718	9242718	3 Door Runner Set, Guide set & Fixing material for Door thickness of 35-50 mm for door weight upto 50 kg	1	Set	1	12,600	83024200
	9242240	9242240	Silent system Soft Closing for 3 door weight upto 50 kg	1	Set	1	10,700	83024200
	9315516	9315516	3000 mm Runner profile and Guide Profile (STB 11 Screw from top)	1	Set	2	4,900	83024200
	BOM Code	9321029	Total Set				28,200	
	<b>TopLine L: Silent System Soft Opening, Soft Colliding &amp; Cover Profile</b>							
	9242227	9242227	Silent system Soft opening for 2 door weight upto 50 kg	1	Set	1	6,000	83024200
	9242228	9242228	Silent system Soft opening for 3 door weight upto 50 kg	1	Set	1	10,700	83024200
	9254630	9254630	Soft colliding for the rear most doors of 3 door sliding door cabinets	1	Set	1	1,370	83024200
	9277167	9277167	4000 mm Runner profile and Guide Profile	1	Set	1	17,012	83024200
	9277440	9277440	Cover Profile 1500 mm Grey Finish	1	Pc	1	800	39169090

# Sliding & Folding Systems

► TopLine 110, TopLine 1



Product	Article No.	SAP	Item Description	Qty.	Unit	PU	MRP	HS Code
---------	-------------	-----	------------------	------	------	----	-----	---------

## Top Running & Inset Wardrobe/Cabinet Sliding Fittings

### TopLine 110



TopLine 110: 2 Door for Wooden & Aluminium Profile Doors – Weight 20 kg per door; Max Door Dimensions: Height 2000 mm & Width 500–1500 mm								
9040230	9040230	Aluminium Runner Profile 3000 mm for gluing in	1	Pc	1	2,140	76042990	
45317	45317	TopLine 110 Set for 2 Door Cabinet (for 16–19 mm door thickness)	1	Set	1	3,450	83024200	
9079731	9079731	Silent System for Wooden Door only (Max door weight 20kg)	1	Set	1	4,630	39263000	

### TopLine 1



TopLine 1: 2 Door for Wooden Doors with STB 11– Weight 50 kg per door; Max Door Dimensions: Height 1500–2500 mm & Width 500–3000 mm								
45076	9303120	Top Door Runner Set for 2 Doors	1	Set	1	3,370	83024200	
9288833	9288833	Aluminium Runner Profile 3000 mm	1	Pc	4	2,861	76042990	
9288836	9288836	STB 11 Aluminium Guide profile 3000 mm	1	Pc	4	2,276	76042990	
45080	45080	STB 11 Guide Set for 2-Doors	1	Set	1	2,315	83024200	
Total Set						10,822		



TopLine 1: 2 Door for Wooden Doors with STB 12– Weight 50 kg per door; Max Door Dimensions: Height 1500–2500 mm & Width 500–3000 mm								
45076	9303120	Top Door Runner Set for 2 Doors	1	Set	1	3,370	83024200	
9288833	9288833	Aluminium Runner Profile 3000 mm	1	Pc	4	2,861	76042990	
9288835	9288835	STB 12 Aluminium Guide profile 3000 mm	1	Pc	4	2,276	76042990	
9325495	9325495	STB 12 Guide Set for 2-Doors	1	Set	1	2,315	83024200	
Total Set						10,822		



TopLine 1: 2 Door for Wooden Doors with STB 35– Weight 50 kg per door; Max Door Dimensions : Height 1500–2500 mm & Width 500–3000 mm								
45076	9303120	Top Door Runner Set for 2 Doors	1	Set	1	3,370	83024200	
9288833	9288833	Aluminium Runner Profile 3000 mm	1	Pc	4	2,861	76042990	
9288829	9288829	STB 35 plastic guide profile 3500 mm	2	Pc	25	442	39169090	
25119	25119	STB 35 Guide Set for 2-Doors	2	Set	100	57	39263000	
Total Set						6,730		

# Sliding & Folding Systems

► SlideLine M, SlideLine 55 & SlideLine 56



Product	Article No.	SAP	Item Description	Qty.	Unit	PU	MRP	HS Code
---------	-------------	-----	------------------	------	------	----	-----	---------

## Bottom Running & Overlay & Inset Cabinet Door Sliding Fittings

### SlideLine M

SlideLine M: 1 Door for Wooden & Aluminium framed Doors - Weight 30 kg per door; Max Door Dimensions: Height 2000 mm & Width 300-1800 mm								
	9156338	9156338	Set fitting SlideLine M with Silent system for Wooden & 55 mm Alu. Profile Doors (Min. Width 450 mm; Weight Max. 30kg; Self Thickness 16-25 mm)	1	Set	1	10,710	83024200
	9209225	9209225	Profile Set SL-M 18/2500 mm 1 Profile	1	Set	1	6,811	76042990
	9209226	9209226	Profile Set SL-M 18/4000 mm 1 Profile	1	Set	1	9,740	76042990
	9209277	9209277	Decorative Silver Cover for 18 mm /2500 mm	1	Set	1	2,625	39199080
	9209278	9209278	Decorative Silver Cover for 18 mm /4000 mm	1	Set	1	3,596	39199080

### SlideLine 55

SlideLine 55: 2 Door for Wooden Doors - Weight 30 kg/door - Alu Runner Profile Max Door Dimensions: Height 1500 mm & Width 400-1500 mm								
	9314320	9314320	Profile 3000 mm	1	Pc	24	260	39169090
	25122	1006347	Running Component for 15 Kg door (For 16-19 mm thick doors)	1	Pc	100	63	39263000
	25123	1006263	Guide Component with Spring Loaded bolt (For 16-19 mm thick doors)	1	Pc	100	78	39263000
	47392	47392	Door Stopper Press-In for 15 kg Door	1	Pc	100	20	39263000
	9079731	9079731	Add-On Silent System (Max Door weight 20 kg)	1	Pc	1	4,630	39263000

### SlideLine 56

SlideLine 56: 2 Door for Wooden Doors- Weight 40 kg per door; Max Door Dimensions: Height 2000 mm & Width 500-1000 mm								
	9288854	9288854	Aluminium Runner Profile 2000 mm Silver	1	Pc	24	380	76042990
	9288856	9288856	Aluminium Runner Profile 3000 mm Silver	1	Pc	24	570	76042990
	9325496	9325496	2 Door Kit for 1 cabinet (16-19 mm thick door)	1	Set	1	1,890	83024200
	9336848	9336848	3 Door Kit for 1 cabinet (16-19 mm thick door)	1	Set	1	2,820	39263000
	9079731	9079731	Add-On Silent System (max door weight 20kg)	1	Set	1	4,630	39263000



# Sliding & Folding Systems

► Grant 400 Neo



Product	Article No.	SAP	Item Description	Qty.	Unit	PU	MRP	HS Code
---------	-------------	-----	------------------	------	------	----	-----	---------

## Grant 400 Neo: Ordering via BOM Code

A. Profile Hardware Set								
	9323591	9323591	Top Et Bottom Track set 2400 mm with 1 Lock SA	1	Set	1	4,789	76042990
	9323592	9323592	Top Et Bottom Track set 2400 mm with 1 Lock BL	1	Set	1	7,302	76042990
	9323593	9323593	Top Et Bottom Track set 2400 mm with 1 Lock DC	1	Set	1	7,302	76042990
	9323594	9323594	Top Et Bottom Track set 3600 mm with 2 Locks SA	1	Set	1	7,782	76042990
	9323595	9323595	Top Et Bottom Track set 3600 mm with 2 Locks BL	1	Set	1	11,549	76042990
	9323596	9323596	Top Et Bottom Track set 3600 mm with 2 Locks DC	1	Set	1	11,549	76042990
Note: Order 1 Set of Profile hardware per wardrobe depending on planned carcass width								

B. Shutter Hardware Set (Per door)								
	9323597	9323597	Shutter Hardware set with C handle Et 1 Middle profile SA for 1 door	1	Set	1	10,266	76042990
	9323599	9323599	Shutter Hardware set with C handle Et 1 Middle profile BL for 1 door	1	Set	1	14,676	76042990
	9323601	9323601	Shutter Hardware set with C handle Et 1 Middle profile DC for 1 door	1	Set	1	14,676	76042990
	9323598	9323598	Shutter Hardware set with R handle Et 1 Middle profile SA for 1 door	1	Set	1	11,848	76042990
	9323600	9323600	Shutter Hardware set with R handle Et 1 Middle profile BL for 1 door	1	Set	1	15,770	76042990
	9323602	9323602	Shutter Hardware set with R handle Et 1 Middle profile DC for 1 door	1	Set	1	15,770	76042990

	9323603	9323603	Shutter Hardware set with C handle Et 2 Middle profiles SA for 1 door	1	Set	1	11,113	76042990
	9323605	9323605	Shutter Hardware set with C handle Et 2 Middle profiles BL for 1 door	1	Set	1	15,927	76042990
	9323607	9323607	Shutter Hardware set with C handle Et 2 Middle profiles DC for 1 door	1	Set	1	15,927	76042990
	9323604	9323604	Shutter Hardware set with R handle Et 2 Middle profiles SA for 1 door	1	Set	1	12,695	76042990
	9323606	9323606	Shutter Hardware set with R handle Et 2 Middle profiles BL for 1 door	1	Set	1	17,021	76042990
	9323608	9323608	Shutter Hardware set with R handle Et 2 Middle profiles DC for 1 door	1	Set	1	17,021	76042990
Note: Order Shutter Hardware 2 Sets for 2 Door Et 3 Sets for 3 Door wardrobe								

## Ordering Example

### 2 Door Wardrobe with 3 Partition, C type handle SA



A. Profile HW set - 9323591 x 1  
4,789 x 1 = 4,789

B. Shutter HW set - 9323603 x 2  
11,113 x 2 = 22,226

**Total (A+B)= 27,015**

### 3 Door Wardrobe with 3 Partition, C type handle SA



A. Profile HW set - 9323594 x 1  
7,782 x 1 = 7,782

B. Shutter HW set - 9323603 x 3  
11,113 x 3 = 33,339

**Total (A+B)= 41,121**

# Sliding & Folding Systems

## ► Grant 400 Neo



Product	Article No.	SAP	Item Description	Qty.	Unit	PU	MRP	HS Code
---------	-------------	-----	------------------	------	------	----	-----	---------

### Grant 400 Neo: Ordering via Child Code

Grant 400 Neo: 2/3 Door (Floor to Ceiling) Sliding system with Soft Closing & Soft Opening; Max door dimensions: Height 3500 mm & Width 1200 mm – Silver Anodized								
	9289653	9289653	Soft closing Dampers & Rollers 50 kg Kit	1	Set	1	2,784	83024100
	9306616	9306616	Soft closing Dampers & Rollers 30 kg Kit	1	Set	1	2,440	83024200
	9296877	9296877	Upper Track, 3600 mm SA	1	Pc	2	3,601	76042990
	9296879	9296879	Bottom Track, 3600 mm SA	1	Pc	2	1,781	76042990
	9296878	9296878	Upper Track, 2400 mm SA	1	Pc	2	2,402	76042990
	9296880	9296880	Bottom Track, 2400 mm SA	1	Pc	2	1,187	76042990
	9296881	9296881	Middle Door Frame Profile - 1200 mm SA	1	Pc	2	577	76042990
	9296882	9296882	Upper Door Frame Profile - 1200 mm SA	1	Pc	2	434	76042990
	9296884	9296884	Bottom Door Frame Profile - 1200 mm SA	1	Pc	2	749	76042990
	9296883	9296883	Vertical door frame cum Handle C type 3500mm SA	1	Pc	2	2,184	76042990
	9306168	9306168	Vertical door frame cum Handle R type 3500mm SA	1	Pc	2	2,975	76042990

Grant 400 Neo: 2/3 Door (Floor to Ceiling) Sliding system with Soft Closing & Soft Opening; Max door dimensions: Height 3500 mm & Width 1200 mm – Black								
	9289653	9289653	Soft closing Dampers & Rollers 50 kg Kit	1	Set	1	2,784	83024100
	9306616	9306616	Soft closing Dampers & Rollers 30 kg Kit	1	Set	1	2,440	83024200
	9302258	9302258	Upper Track, 3600 mm Black	1	Pc	2	6,122	76042990
	9302259	9302259	Bottom Track, 3600 mm Black	1	Pc	2	3,027	76042990
	9300500	9300500	Upper Track, 2400 mm Black	1	Pc	2	4,084	76042990
	9300511	9300511	Bottom Track, 2400 mm Black	1	Pc	2	2,018	76042990
	9300512	9300512	Middle Door Frame Profile - 1200 mm Black	1	Pc	2	981	76042990
	9300497	9300497	Upper Door Frame Profile - 1200 mm Black	1	Pc	2	782	76042990
	9300499	9300499	Bottom Door Frame Profile - 1200 mm Black	1	Pc	2	1,349	76042990
	9300498	9300498	Vertical door frame cum Handle C type 3500mm BL	1	Pc	2	3,713	76042990
	9306169	9306169	Vertical door frame cum Handle R type 3500mm BL	1	Pc	2	4,260	76042990

Grant 400 Neo: 2/3 Door (Floor to Ceiling) Sliding system with Soft Closing & Soft Opening; Max door dimensions: Height 3500 mm & Width 1200 mm – Dark Champagne								
	9289653	9289653	Soft closing Dampers & Rollers 50 kg Kit	1	Set	2	2,784	83024100
	9306616	9306616	Soft closing Dampers & Rollers 30 kg Kit	1	Pc	2	2,440	83024200
	9319946	9319946	Upper Track, 3600 mm DC	1	Pc	2	6,122	76042990
	9319947	9319947	Bottom Track, 3600 mm DC	1	Pc	2	3,027	76042990
	9319944	9319944	Upper Track, 2400 mm DC	1	Pc	2	4,084	76042990
	9319945	9319945	Bottom Track, 2400 mm DC	1	Pc	2	2,018	76042990
	9319948	9319948	Middle Door Frame Profile - 1200 mm DC	1	Pc	2	981	76042990
	9319929	9319929	Upper Door Frame Profile - 1200 mm DC	1	Pc	2	782	76042990
	9319941	9319941	Bottom Door Frame Profile - 1200 mm DC	1	Pc	2	1,349	76042990
	9319943	9319943	Vertical door frame cum Handle C type 3500mm DC	1	Pc	2	3,713	76042990
	9320013	9320013	Vertical door frame cum Handle R type 3500mm DC	1	Pc	2	4,260	76042990





### Grant 400 Neo: Accessories

	9293857	9293857	Fixing Screw ST 6X30 mm for Grant 400 Neo Profiles	1	Pc	5	16	73181400
	9295418	9295418	Sealing Brush 7X8 mm, 3500 mm SA	1	Pc	1	131	39204900
	9348093	9348093	Sealing Brush 7X8 mm, 3500 mm BL	1	Pc	1	131	39204900
	9348094	9348094	Sealing Brush 7X8 mm, 3500 mm DG	1	Pc	1	131	39204900
	9293855	9293855	Glass Sealing Strip 6mm for Grant 400 Neo, 1200 mm	1	Pc	1	95	39204900
	9293856	9293856	Glass Sealing Strip 6mm for Grant 400 Neo, 3500 mm	1	Pc	1	276	39204900
	9305699	9305699	Grant 400 Neo Lock 120 KC SA	1	Set	1	1,200	39204900
	9341201	9341201	Grant 400 Neo Lock 120 KC BL	1	Set	1	1,200	83013000
	9341203	9341203	Grant 400 Neo Lock 120 KC DC	1	Set	1	1,200	83013000

# Sliding & Folding Systems

► Vertico Synchro, Vertico Mono & WingLine L



Product	Article No.	SAP	Item Description	Qty.	Unit	PU	MRP	HS Code
<b>Vertically running Door Sliding Fittings: Vertico Synchro &amp; Vertico Mono</b>								
	<b>Vertico Synchro: 2 Door for Wooden and Aluminium Profile Doors – Weight 15 kg per door; Max Door Dimensions: Height 400–600 mm &amp; Width 1500 mm max.</b>							
	20386	20386	Vertico Synchro Set 400 for Overlay Door height 400-600 mm	1	Set	1	30,250	83024200
	20400	20400	Cover Profile 2500 mm Aluminium Silver anodised	2	Pc	1	4,070	76042990
	<b>Vertico Mono: 1 Door for Wooden and Aluminium Profile Doors – Weight 15 kg per door; Max Door Dimensions: Height 400–700 mm &amp; Width 1500 mm max.</b>							
	45315	45315	Set Vertico Mono for inset door	1	Set	1	25,480	83024200
	20400	20400	Cover Profile 2500 mm Aluminium Silver anodised	2	Pc	1	4,070	76042990
<b>Folding Door System for Wardrobe / Cabinet</b>								
<b>WingLine L</b>								
	<b>Wingline L Push to move – Weight 5 kg to 12 kg per wing ; Max Door Dimensions : 1600 mm Height &amp; 600 mm Door Wing Width (Order Sensys 8675 Hinges Separately)</b>							
	9237901	9237901	Wing Line L Kit - Left	1	Pc	1	2,680	83024200
	9237900	9237900	Wing Line L Kit - Right	1	Pc	1	2,680	83024200
	9238051	9238051	Push to Move Mechanisms Medium- Left	1	Pc	1	9,252	83024200
	9238101	9238101	Push to Move Mechanisms Medium- Right	1	Pc	1	9,252	83024200
	9307515	9307515	Runner Profile - 2400 mm	1	Pc	2	2,898	76042990
	9237758	9237758	Profile Mounting Clip	2	Pc	1	240	39269097
	<b>Wingline L Push to move – Weight 12 kg to 25 Kg per wing ; Max Door Dimensions : 2400 mm Height &amp; 600 mm Door Wing Width (Order Sensys 8675 Hinges Separately) Profile size: 2400 mm</b>							
	9237880	9237880	Wing Line L Kit - Left	1	Pc	1	4,386	83024200
	9237881	9237881	Wing Line L Kit - Right	1	Pc	1	4,386	83024200
	9238052	9238052	Push to Move Mechanisms Heavy - Left	1	Pc	1	9,970	83024200
	9238053	9238053	Push to Move Mechanisms Heavy - Right	1	Pc	1	9,970	39263000
	9313037	9313037	Profile Set 2400 mm SA Finish	1	Pc	1	4,383	76042990
	9264191	9264191	Mechanical Catch	1	Set	50	1,260	83024200
	<b>Wingline L Pull to move – Weight 5 kg to 12 kg per wing ; Max Door Dimensions : 1600 mm Height &amp; 600 mm Door Wing Width (Order Sensys 8675 Hinges Separately)</b>							
	9237901	9237901	Wing Line L Kit - Left	1	Pc	1	2,680	83024200
	9237900	9237900	Wing Line L Kit - Right	1	Pc	1	2,680	83024200
	9238115	9238115	Pull to move Mechanisms Medium- Left	1	Pc	1	9,780	83024200
	9238116	9238116	Pull to move Mechanisms Medium- Right	1	Pc	1	9,252	83024200
	9307515	9307515	Runner Profile - 2400 mm	1	Pc	2	2,898	76042990
	9237758	9237758	Profile Mounting Clip	2	Pc	1	240	39269097

# Sliding & Folding Systems

▶ WingLine L, WingLine 230 & Accessories









Product	Article No.	SAP	Item Description	Qty.	Unit	PU	MRP	HS Code
	<b>Wingline L Pull to move - Weight 12 kg to 25 Kg per wing ; Max Door Dimensions : 2400 mm Height &amp; 600 mm Door Wing Width (Order Sensys 8675 Hinges Separately)</b>							
	9237880	9237880	Wing Line L Kit - Left	1	Pc	1	4,386	83024200
	9237881	9237881	Wing Line L Kit - Right	1	Pc	1	4,386	83024200
	9238125	9238125	Pull to move Mechanisms Heavy - Left	1	Pc	1	10,540	83024200
	9238114	9238114	Pull to move Mechanisms Heavy - Right	1	Pc	1	10,540	83024200
	9313037	9313037	Profile Set 2400 mm SA Finish	1	Pc	1	4,383	76042990
	<b>Wingline L Pull to move Silent - Weight 5 kg to 12 kg per wing ; Max Door Dimensions : 1600 mm Height &amp; 600 mm Door Wing Width (Order Sensys 8645i Hinges Separately)</b>							
	9237903	9237903	Wing Line L Kit - Left	1	Pc	1	2,626	83024200
	9237902	9237902	Wing Line L Kit - Right	1	Pc	1	2,626	83024200
	9238121	9238121	Pull to move Silent Mechanisms Medium- Left	1	Pc	1	7,890	83024200
	9238124	9238124	Pull to move Silent Mechanisms Medium- Right	1	Pc	1	8,239	83024200
	9307515	9307515	Runner Profile - 2400 mm	1	Pc	2	2,898	76042990
	9237758	9237758	Profile Mounting Clip	2	Pc	1	240	39269097
	<b>Wingline L Pull to move Silent - Weight 12 kg to 25 Kg per wing ; Max Door Dimensions : 2400 mm Height &amp; 600 mm Door Wing Width (Order Sensys 8645i Hinges Separately) Profile size: 2400 mm</b>							
	9237852	9237852	Wing Line L Kit - Left	1	Pc	1	4,480	83024200
	9237890	9237890	Wing Line L Kit - Right	1	Pc	1	4,480	83024200
	9238123	9238123	Pull to move Silent Mechanisms Heavy - Left	1	Pc	1	8,813	39269097
	9238122	9238122	Pull to move Silent Mechanisms Heavy - Right	1	Pc	1	8,813	39269097
	9313037	9313037	Profile Set 2400 mm SA Finish	1	Pc	1	4,383	76042990
	<b>WingLine 230: 2 Doors with 4 Wings for Wooden Doors - Weight 20-25 kg per door; Max Door Dimensions: Height 3000mm &amp; Door wing Width 600 mm (Order Hinges Separately)</b>							
	79013	1079849	Runner profile Aluminium White 2400 mm	1	Pc	4	8,640	76042990
	79015	9225395	WingLine 230 Set of 4 Wings (Left & Right) (16-25 mm Door thickness)	1	Set	1	29,240	83024200
<b>Accessories for Sliding &amp; Folding Doors</b>								
	45198	9189775	Door Bend Adjustment Rod Fitting - Steel threaded rod with plastic covers	1	Set	2	1,150	83024200
	26453	26453	Brush Sealing Strip 2500mm (27 mm height.; Screw on Brown)	1	Pc	40	1,540	39269097
	9200386	9200386	Self Adhesive Brush Sealing Strip 2500 mm (8 mm height)	1	Pc	1	270	39269097
	9071313	9071313	Sensys 8675 Hinge ; Opening Angle 110° for Push to move and Pull to Move Mechanisms	1	Pc	1	350	83021000
	9091575	9091575	Sensys Mount Plate	1	Pc	1	32	83021000
	9237758	9237758	Profile Mounting Clip	1	Pc	1	120	39269097



# Sliding & Folding Systems

▶ TopLine 80, TopLine 80 SiSy, TopLine 120 SiSy  
& SlideLine 16



Product	Article No.	SAP	Item Description	Qty.	Unit	PU	MRP	HS Code
<b>Top Running Sliding &amp; Folding Door System as Space Dividers</b>								
<b>Sliding</b>								
	<b>TopLine 80: Single profile Top Running Door – Weight 80 kg/door; Max Door Dimensions: Width1000/1500 mm (Max.)</b>							
	14005	9089915	Kit for 1 Door (Door Thickness : 25 mm upwards)	1	Set	1	3,910	76042990
	9288841	9288841	Runner profile anodised aluminium profile 2000 mm	1	Pc	4	2,134	76042990
	9295969	9295969	Runner profile anodised aluminium profile 3000 mm	1	Pc	4	3,177	76042990
	<b>TopLine 80 SiSy: Single Profile Top Running Door – Weight 80 kg/door; Max Door Dimensions: Width1000/1500 mm (Max.)</b>							
	9289654	9289654	Sliding Kit for 80 kg door with Silent system (Opening & Closing)	1	Set	1	4,956	83024100
	9295967	9295967	Runner profile anodised aluminium profile 2000 mm	1	Pc	4	1,940	76042990
	9295968	9295968	Runner profile anodised aluminium profile 3000 mm	1	Pc	4	2,920	76042990
9289655	9289655	Aluminium profile fixing Acc (For Wall Hanging only)	1	Pc	50	220	83024100	
	<b>TopLine 120 SiSy: Heavy duty soft close sliding door system for room dividers – Weight 120 kg/door; Max door dimensions: Width 1500 mm (Max.)</b>							
	9297034	9297034	Hanging Roller Sliding System with Opening & Closing Dampener with Bottom Guide for 1 Door	1	Set	1	7,388	83024100
	9302260	9302260	Runner Profile, 3000 mm – Silver Anodized	1	Pc	2	6,581	76042990
	<b>SlideLine 16: 2 Door for Wooden doors with 2 m screw on track –Weight 60 kg per door; thickness 18–24 mm</b>							
	9226025	9226025	SL 16- Fitting Set	1	Set	1	1,345	83024200
	9288847	9288847	SL 16- Profile Set Screw 2000 mm–Silver Anodized	1	Set	8	1,634	76169990
	9322053	9322053	Silent System	1	Set	1	1,057	83024200
	BOM Code	9307045	Total Set				4,036	
	<b>SlideLine 16: 2 Door for Wooden doors with 3 m screw on track –Weight 60 kg per door; thickness 18–24 mm</b>							
	9226025	9226025	SL 16- Fitting Set	1	Set	1	1,345	83024200
	9288846	9288846	SL 16- Profile Set Screw 3000 mm – Silver Anodized	1	Set	8	2,303	76169990
	9322053	9322053	Silent System	1	Set	1	1,057	83024200
	BOM Code	9307047	Total Set				4,705	
	<b>SlideLine 16: 2 Door for Wooden doors with 2 m screw on track –Weight 60 kg per door; thickness 18–24 mm</b>							
	9226025	9226025	SL 16- Fitting Set	1	Set	1	1,345	83024200
	9299228*	9299228*	SL 16- Profile Set Screw 2000 mm – Black	1	Pc	8	2,614	76169990
	9322053	9322053	Silent System	1	Set	1	1,057	83024200
	BOM Code	9307048	Total Set				5,016	

\*Available till stock last

# Sliding & Folding Systems

► SlideLine 16, Grant 1230, Grant 1260



Product	Article No.	SAP	Item Description	Qty.	Unit	PU	MRP	HS Code
	<b>SlideLine 16: 2 Door for Wooden doors with 2 m screw on track -Weight 60 kg per door; thickness 18-24 mm</b>							
	9226025	9226025	SL 16- Fitting Set	1	Set	1	1,345	83024200
	9323233*	9323233*	SL 16- Profile Set Screw 2000 mm-DC	1	Pc	8	2,614	76169990
	9322053	9322053	Silent System	1	Set	1	1,057	83024200
			Total Set				5,016	
	<b>SlideLine 16: 2 Door for Wooden doors with 3 m screw on track -Weight 60 kg per door; thickness 18-24 mm</b>							
	9226025	9226025	SL 16- Fitting Set	1	Set	1	1,345	83024200
	9323231*	9323231*	SL 16- Profile Set Screw 3000 mm-DC	1	Pc	8	3,406	76169990
	9322053	9322053	Silent System	1	Set	1	1,057	83024200
			Total Set				5,808	
	<b>Grant 1230 with 3000 mm Runner, 147 Kg / Door, max. height 3000 mm &amp; min. thickness 25.5 mm</b>							
	9296872	9296872	Runner profile, 3000 mm	1	Pc	2	4,861	76042990
	9308695	9308695	Kit for 1 door	1	Set	1	7,034	83024190
	9308696	9308696	TopLine 1230 Bumper stop	1	Pc	2	1,300	83024200
	9308697	9308697	Floor Guide Tab Steel	1	Pc	10	550	83024200
		Total Set				13,745		
	<b>Grant 1230 with 3600 mm Runner, 147 Kg / Door, max. height 3000 mm &amp; min. thickness 25.5 mm</b>							
	9296873	9296873	Runner profile, 3600 mm	1	Pc	2	7,115	76041090
	9308695	9308695	Kit for 1 door	1	Set	1	7,034	83024190
	9308696	9308696	TopLine 1230 Bumper stop	1	Pc	2	1,300	83024200
	9308697	9308697	Floor Guide Tab Steel	1	Pc	10	550	83024200
		Total Set				15,999		
	<b>Grant 1260 with 3000 mm Runner (For Heavy Duty Folding Doors) - 80 Kg / Door</b>							
	9308610	9308610	Kit for 1 fold	1	Set	1	12,331	83024200
	9296875	9296875	Guide profile, 3000 mm	1	Pc	2	2,585	76041090
	9296872	9296872	Runner profile, 3000 mm	1	Pc	2	4,861	76042990
	9308642	9308642	Guide rollers	1	Pc	1	1,083	83024190
		Total Set				20,860		
	<b>Grant 1260 with 3600 mm Runner (For Heavy Duty Folding Doors) - 80 Kg / Door</b>							
	9308610	9308610	Kit for 1 fold	1	Set	1	12,331	83024200
	9296876	9296876	Guide profile, 3600 mm	1	Pc	2	2,769	76041090
	9296873	9296873	Runner profile, 3600 mm	1	Pc	2	7,115	76041090
	9308642	9308642	Guide rollers	1	Pc	1	1,083	83024190
		Total Set				23,298		

\*Available till stock last



Quadro



KA Telescopic



FR Runner

## Drawer Runners

Smooth & effortless movement

Hettich Drawer Runners are a core product in the realm of furniture hardware. Known for its outstanding quality and reliability, it excels at providing smooth and quiet drawer operation. These runners' precision engineering ensures that drawers glide in and out effortlessly, even when fully loaded.

IT'S ALL IN HETTICH.



Product	Article No.	SAP	Item Description	Qty.	Unit	PU	MRP	HS Code
	<b>Quadro - 25 Partial Extension with Silent System 25 kg</b>							
	9243222	9243222	250 mm with catches	1	Set	10	1,234	83021090
	9243223	9243223	300 mm with catches	1	Set	10	1,308	83021090
	9243224	9243224	350 mm with catches	1	Set	10	1,270	83021090
	9243225	9243225	400 mm with catches	1	Set	10	1,310	83021090
	9243226	9243226	450 mm with catches	1	Set	10	1,346	83021090
	9243227	9243227	500 mm with catches	1	Set	10	1,384	83021090
	9243228	9243228	550 mm with catches	1	Set	10	1,490	83021090
	<b>Quadro-V6 Full Extension 30 Kg with Silent System</b>							
	9243229	9243229	300 mm with catches	1	Set	10	2,800	83024200
	9243230	9243230	350 mm with catches	1	Set	10	2,800	83024200
	9243231	9243231	400 mm with catches	1	Set	10	3,050	83024200
	9243232	9243232	450 mm with catches	1	Set	10	3,170	83024200
	9243233	9243233	500 mm with catches	1	Set	10	3,290	83024200
	9243234	9243234	550 mm with catches	1	Set	10	3,530	83024200
	9243235	9243235	600 mm with catches	1	Set	10	3,900	83024200
	<b>Quadro 25 Partial Extension with P20 25 Kg</b>							
	9243236	9243236	300 mm with catches	1	Set	10	1,860	83021090
	9243237	9243237	350 mm with catches	1	Set	10	1,940	83021090
	9243238	9243238	400 mm with catches	1	Set	10	2,020	83021090
	9243239	9243239	450 mm with catches	1	Set	10	2,100	83021090
	9243240	9243240	500 mm with catches	1	Set	10	2,180	83021090
	<b>Quadro Catches for wooden drawers</b>							
	9144830	9144830	Left	1	Pc	10	57	39263000
	9144841	9144841	Right	1	Pc	10	57	39263000
	<b>Quadro YOU Full Extension with Silent System 30 kg</b>							
	9320860	9320860	250 mm with catches	1	Set	10	2,742	83024200
	9320881	9320881	300 mm with catches	1	Set	10	2,822	83024200
	9320882	9320882	350 mm with catches	1	Set	10	2,822	83024200
	9320883	9320883	400 mm with catches	1	Set	10	3,072	83024200
	9320884	9320884	450 mm with catches	1	Set	10	3,192	83024200
	9320885	9320885	500 mm with catches	1	Set	10	3,312	83024200
	9320886	9320886	550 mm with catches	1	Set	10	3,552	83024200
	9320887	9320887	600 mm with catches	1	Set	10	3,922	83024200
	<b>Quadro YOU Full Extension with Push to Open 30 kg</b>							
	9320852	9320852	250 mm with catches	1	Set	10	3,144	83024200
	9320853	9320853	300 mm with catches	1	Set	10	3,252	83024200
	9320854	9320854	350 mm with catches	1	Set	10	3,336	83024200
	9320855	9320855	400 mm with catches	1	Set	10	3,528	83024200
	9320856	9320856	450 mm with catches	1	Set	10	3,694	83024200
	9320857	9320857	500 mm with catches	1	Set	10	3,962	83024200
	9320858	9320858	550 mm with catches	1	Set	10	4,300	83024200
	9320859	9320859	600 mm with catches	1	Set	10	4,500	83024200
	<b>Quadro YOU Catches for wooden drawers</b>							
	9257260	9257260	Left	1	Pc	10	111	83024200
	9257261	9257261	Right	1	Pc	10	111	83024200



# Drawer Runners

► KA







Product	Article No.	SAP	Article No.	SAP	Item Description	Qty.	Unit	PU	MRP	HS Code	
	<b>KA 5632 45 kg Zinc / Black</b>										
	<b>Zinc</b>		<b>Black</b>								
	9293321	9293321	9293322	9293322	200 mm	1	Set	10	439	83024200	
	73276	9215435	44916	9215445	250 mm	1	Set	10	439	83024200	
	73277	9215436	44915	9215446	300 mm	1	Set	10	459	83024200	
	73278	9215437	44914	9215447	350 mm	1	Set	10	479	83024200	
	73279	9209240	44913	9215448	400 mm	1	Set	10	499	83024200	
	73280	9209239	44912	9215449	450 mm	1	Set	10	529	83024200	
	73281	9193319	44911	9215450	500 mm	1	Set	10	549	83024200	
	73282	9215441	44909	9215451	550 mm	1	Set	10	649	83024200	
	73283	9215442	44908	9215452	600 mm	1	Set	10	749	83024200	
	73284	9215443	44907	9215453	650 mm	1	Set	10	849	83024200	
	41355	9215444	44906	9215454	700 mm	1	Set	10	949	83024200	
		<b>KA 4532, 35 kg Silent System / P20 Zinc</b>									
<b>Silent System</b>		<b>Push To Open</b>									
9114271		9114271	9114281	9114281	300 mm	1	Set	10	1,229	83024200	
9114273		9114273	9114282	9114282	350 mm	1	Set	10	1,283	83024200	
9114274		9114274	9114283	9114283	400 mm	1	Set	10	1,337	83024200	
9114275		9114275	9114284	9114284	450 mm	1	Set	10	1,392	83024200	
9114276		9114276	9114285	9114285	500 mm	1	Set	10	1,446	83024200	
9114277		9114277	9114286	9114286	550 mm	1	Set	10	1,500	83024200	
9114278		9114278	9114288	9114288	600 mm	1	Set	10	1,555	83024200	
9114279		9114279	9114289	9114289	650 mm	1	Set	10	1,609	83024200	
9114280		9114280	9114290	9114290	700 mm	1	Set	10	1,663	83024200	
	<b>KA 4732 with Silent System 35 kg Zinc / Black</b>										
	<b>Zinc</b>		<b>Black</b>								
	9347743	9347743	9347748	9347748	250 mm	1	Set	10	1,175	83024200	
	9318185	9318185	9318202	9318202	300 mm	1	Set	10	1,229	83024200	
	9318189	9318189	9318204	9318204	350 mm	1	Set	10	1,283	83024200	
	9318193	9318193	9318205	9318205	400 mm	1	Set	10	1,337	83024200	
	9318195	9318195	9318206	9318206	450 mm	1	Set	10	1,392	83024200	
	9318197	9318197	9318207	9318207	500 mm	1	Set	10	1,446	83024200	
	9318200	9318200	9318210	9318210	550 mm	1	Set	10	1,500	83024200	
	9347744	9347744	9347749	9347749	600 mm	1	Set	10	1,555	83024200	
	9347746	9347746	9347750	9347750	650 mm	1	Set	10	1,609	83024200	
	9347747	9347747	9347761	9347761	700 mm	1	Set	10	1,663	83024200	

# Drawer Runners

► KA & FR



Product	Article No.	SAP	Item Description	Qty.	Unit	PU	MRP	HS Code	
	<b>KA 4620 90 Kg</b>								
	41392	41392	400 mm	1	Set	5	1,913	83024200	
	41393	41393	450 mm	1	Set	5	2,067	83024200	
	41394	41394	500 mm	1	Set	5	2,227	83024200	
	41395	41395	550 mm	1	Set	5	2,397	83024200	
	41396	41396	600 mm	1	Set	5	2,629	83024200	
	41397	41397	650 mm	1	Set	5	2,808	83024200	
	41398	41398	700 mm	1	Set	5	2,930	83024200	
	<b>FR 302, 20 kg with stop control</b>								
	75993	75993	250 mm	1	Set	20	129	83024200	
	1083317	1083317	300 mm	1	Set	20	141	83024200	
	1083318	1083318	350 mm	1	Set	20	157	83024200	
	1083319	1083319	400 mm	1	Set	20	176	83024200	
	1083320	1083320	450 mm	1	Set	20	196	83024200	
	1083321	1083321	500 mm	1	Set	20	213	83024200	
	9006351	9006351	550 mm	1	Set	20	236	83024200	
	<b>KA 5740, 8 kg per shutter</b>								
	41371	41371	300 mm	1	Set	1	1,065	83024200	
	41372	41372	350 mm	1	Set	1	1,282	83024200	
	41373	41373	400 mm	1	Set	1	1,356	83024200	
	41374	41374	450 mm	1	Set	1	1,409	83024200	
	41375	41375	500 mm	1	Set	1	1,478	83024200	
	41376	41376	550 mm	1	Set	1	1,536	83024200	
	41377	41377	600 mm	1	Set	1	1,605	83024200	
	41378	41378	650 mm	1	Set	1	1,517	83024200	
	41379	41379	700 mm	1	Set	1	1,737	83024200	
	<b>KA 5740 Accessory Kit</b>								
	9079526	9079526	KA 5740 Accessory Kit	1	Set	1	415	83024200	





Arcitech



InnoTech



InnoTech Atira

## Drawer Systems

Thousands of options to choose from

The Hettich drawer systems are cutting-edge and innovative solutions for all your storage needs. Known for its exceptional design and functionality, they offer a perfect blend of aesthetics and practicality. With customizable features, the drawer system caters to various design preferences and storage requirements, making it a versatile choice for modern kitchens, bathrooms, & other living spaces.

IT'S ALL IN HETTICH.



# Drawer System: AvanTech YOU

- ▶ Drawer height 101 mm
- ▶ Silver



Product	Article No.	SAP	Item Description	Qty.	Unit	PU	MRP	HS Code
	<b>AvanTech You: NL-400 mm Height-101 mm (40 Kg) Full Extn. Silent</b>							
	9255014	9255014	Drawer side profile (Silver)-Left	1	Pc	1	1,342	94039010
	9255015	9255015	Drawer side profile (Silver)-Right	1	Pc	1	1,342	94039010
	9255807	9255807	Design profile (Silver)	2	Pc	2	292	39169090
	9255835	9255835	Front connector for drawer side profile	2	Pc	2	806	83024200
	9257666	9257666	Rear Panel Connector (Silver), Left	1	Pc	1	305	83024200
	9257667	9257667	Rear panel connector (Silver), Right	1	Pc	1	305	83024200
	9257702	9257702	Rear Panel stabilizer	3	Pc	3	39	39263000
	9123080	9123080	Front stabiliser	1	Pc	1	438	39263000
	9318175	9318175	Actro You Drawer runner-40kg, Left	1	Pc	1	1,715	83024200
	9318176	9318176	Actro You Drawer runner-40kg, Right	1	Pc	1	1,715	83024200
	9257703	9257703	Branding clip with Hettich Logo- (Silver)	1	Pc	1	40	39269097
BOM Code	9308044						8,339	
	<b>AvanTech You: NL-450 mm Height-101 mm (40 Kg) Full Extn. Silent</b>							
	9255016	9255016	Drawer Side Profile (Silver), Left	1	Pc	1	1,485	94039010
	9255017	9255017	Drawer Side Profile (Silver), Right	1	Pc	1	1,485	94039010
	9255808	9255808	Design Profile (Silver)	2	Pc	2	276	39169090
	9255835	9255835	Font Panel Connector for drawer side profile	2	Pc	2	806	83024200
	9257666	9257666	Rear Panel Connector (Silver), Left	1	Pc	1	305	83024200
	9257667	9257667	Rear Panel Connector (Silver), Right	1	Pc	1	305	83024200
	9257702	9257702	Rear Panel Stabilizer	3	Pc	3	39	39263000
	9123080	9123080	Front Stabilizer	1	Pc	1	438	39263000
	9318177	9318177	Actro You runner Left, 40 kg	1	Pc	1	1,750	83024200
	9318178	9318178	Actro You runner Right, 40 kg	1	Pc	1	1,750	83024200
	9257703	9257703	Branding clip with Hettich logo ( silver)	1	Pc	1	40	39269097
BOM Code	9307350						8,679	
	<b>AvanTech You: NL-500 mm Height-101 mm (40 Kg) Full Extn. Silent</b>							
	9255018	9255018	Drawer Side Profile (Silver), Left	1	Pc	1	1,518	94039010
	9255019	9255019	Drawer Side Profile (Silver), Right	1	Pc	1	1,518	94039010
	9255809	9255809	Design Profile (Silver)	2	Pc	2	276	39169090
	9255835	9255835	Font Panel Connector for drawer side profile	2	Pc	2	806	83024200
	9257666	9257666	Rear Panel Connector (Silver), Left	1	Pc	1	305	83024200
	9257667	9257667	Rear Panel Connector (Silver), Right	1	Pc	1	305	83024200
	9257702	9257702	Rear Panel Stabilizer	3	Pc	3	39	39263000
	9123080	9123080	Front Stabilizer	1	Pc	1	438	39263000
	9318179	9318179	Actro You runner (Left), 40 kg	1	Pc	1	1,771	83024200
	9318180	9318180	Actro You runner (Right), 40 kg	1	Pc	1	1,771	83024200
	9257703	9257703	Branding clip with Hettich logo ( Silver)	1	Pc	1	40	39269097
BOM Code	9298403						8,787	
	<b>AvanTech You: NL-550 mm Height-101 mm (40 Kg) Full Extn. Silent</b>							
	9255020	9255020	Drawer Side Profile (Silver), Left	1	Pc	1	1,541	94039010
	9255021	9255021	Drawer Side Profile (Silver), Right	1	Pc	1	1,541	94039010
	9255810	9255810	Design Profile (Silver)	2	Pc	2	276	39169090
	9255835	9255835	Font Panel Connector for drawer side profile	2	Pc	2	806	83024200
	9257666	9257666	Rear Panel Connector (Silver), Left	1	Pc	1	305	83024200
	9257667	9257667	Rear Panel Connector (Silver), Right	1	Pc	1	305	83024200
	9257702	9257702	Rear Panel Stabilizer	3	Pc	3	39	39263000
	9123080	9123080	Front Stabilizer	1	Pc	1	438	39263000
	9318181	9318181	Actro You runner (Left), 40 kg	1	Pc	1	1,886	83024200
	9318182	9318182	Actro You runner (Right), 40 kg	1	Pc	1	1,886	83024200
	9257703	9257703	Branding clip with Hettich logo (silver)	1	Pc	1	40	39269097
BOM Code	9307389						9,063	



# Drawer System: AvanTech YOU

- ▶ Drawer height 101 mm
- ▶ Silver







Product	Article No.	SAP	Item Description	Qty.	Unit	PU	MRP	HS Code
	<b>AvanTech You: NL-450 mm Height-101 mm (70 Kg) Full Extn. Silent</b>							
	9255016	9255016	Drawer Side Profile (Silver), Left	1	Pc	1	1,485	94039010
	9255017	9255017	Drawer Side Profile (Silver), Right	1	Pc	1	1,485	94039010
	9255808	9255808	Design Profile (Silver)	2	Pc	2	276	39169090
	9255835	9255835	Font Panel Connector for drawer side profile	2	Pc	2	806	83024200
	9257666	9257666	Rear Panel Connector (Silver), Left	1	Pc	1	305	83024200
	9257667	9257667	Rear Panel Connector (Silver), Right	1	Pc	1	305	83024200
	9257702	9257702	Rear Panel Stabilizer	3	Pc	3	39	39263000
	9123080	9123080	Front Stabilizer	1	Pc	1	438	39263000
	9257013	9257013	Actro You runner (Left), 70 kg	1	Pc	1	2,291	83024200
	9257014	9257014	Actro You runner (Right), 70 kg	1	Pc	1	2,291	83024200
	9257703	9257703	Branding clip with Hettich logo (silver)	1	Pc	1	40	39269097
BOM Code	9307363						9,761	
	<b>AvanTech You: NL-500 mm Height-101 mm (70 Kg) Full Extn. Silent</b>							
	9255018	9255018	Drawer Side Profile (Silver), Left	1	Pc	1	1,518	94039010
	9255019	9255019	Drawer Side Profile (Silver), Right	1	Pc	1	1,518	94039010
	9255809	9255809	Design Profile (Silver)	2	Pc	2	276	39169090
	9255835	9255835	Font Panel Connector for drawer side profile	2	Pc	2	806	83024200
	9257666	9257666	Rear Panel Connector (Silver), Left	1	Pc	1	305	83024200
	9257667	9257667	Rear Panel Connector (Silver), Right	1	Pc	1	305	83024200
	9257702	9257702	Rear Panel Stabilizer	3	Pc	3	39	39263000
	9123080	9123080	Front Stabilizer	1	Pc	1	438	39263000
	9257017	9257017	Actro You runner (Left), 70 kg	1	Pc	1	2,319	83024200
	9257018	9257018	Actro You runner (Right), 70 kg	1	Pc	1	2,319	83024200
	9257703	9257703	Branding clip with Hettich logo (Silver)	1	Pc	1	40	39269097
BOM-Code	9298406						9,883	
	<b>AvanTech You: NL-550 mm Height-101 mm (70 Kg) Full Extn. Silent</b>							
	9255020	9255020	Drawer Side Profile (Silver), Left	1	Pc	1	1,541	94039010
	9255021	9255021	Drawer Side Profile (Silver), Right	1	Pc	1	1,541	94039010
	9255810	9255810	Design Profile (Silver)	2	Pc	2	276	39169090
	9255835	9255835	Font Panel Connector for drawer side profile	2	Pc	2	806	83024200
	9257666	9257666	Rear Panel Connector (Silver), Left	1	Pc	1	305	83024200
	9257667	9257667	Rear Panel Connector (Silver), Right	1	Pc	1	305	83024200
	9257702	9257702	Rear Panel Stabilizer	3	Pc	3	39	39263000
	9123080	9123080	Front Stabilizer	1	Pc	1	438	39263000
	9257021	9257021	Actro You runner (Left), 70 kg	1	Pc	1	2,438	83024200
	9257022	9257022	Actro You runner (Right), 70 kg	1	Pc	1	2,438	83024200
	9257703	9257703	Branding clip with Hettich logo (silver)	1	Pc	1	40	39269097
BOM-Code	9307392						10,167	



# Drawer System: AvanTech YOU

- ▶ Drawer height 187mm
- ▶ Silver



Product	Article No.	SAP	Item Description	Qty.	Unit	PU	MRP	HS Code
	<b>AvanTech You: NL-400 mm Height-187 mm (40 Kg) Full Extn. Silent</b>							
	9255050	9255050	Drawer Side Profile (Silver), Left	1	Pc	1	2,128	94039010
	9255051	9255051	Drawer Side Profile (Silver), Right	1	Pc	1	2,128	94039010
	9255807	9255807	Design Profile (Silver)	2	Pc	2	292	39169090
	9255838	9255838	Font Panel Connector for drawer side profile	2	Pc	2	1,496	83024200
	9257670	9257670	Rear Panel Connector (Silver), Left	1	Pc	1	450	83024200
	9257671	9257671	Rear Panel Connector (Silver), Right	1	Pc	1	450	83024200
	9257702	9257702	Rear Panel Stabilizer	3	Pc	3	39	39263000
	9123080	9123080	Front Stabilizer	1	Pc	1	438	39263000
	9318175	9318175	Actro You runner Left, 40 kg	1	Pc	1	1,715	83024200
	9318176	9318176	Actro You runner Right, 40 kg	1	Pc	1	1,715	83024200
	9257703	9257703	Branding clip with Hettich Logo (Silver)	1	Pc	1	40	39269097
BOM Code	9308045						10,891	
	<b>AvanTech You: NL-450 mm Height-187 mm (40 Kg) Full Extn. Silent</b>							
	9255052	9255052	Drawer Side Profile (Silver), Left	1	Pc	1	2,210	94039010
	9255053	9255053	Drawer Side Profile (Silver), Right	1	Pc	1	2,210	94039010
	9255808	9255808	Design Profile (Silver)	2	Pc	2	276	39169090
	9255838	9255838	Font Panel Connector for drawer side profile	2	Pc	2	1,496	83024200
	9257670	9257670	Rear Panel Connector (Silver), Left	1	Pc	1	450	83024200
	9257671	9257671	Rear Panel Connector (Silver), Right	1	Pc	1	450	83024200
	9257702	9257702	Rear Panel Stabilizer	3	Pc	3	39	39263000
	9123080	9123080	Front Stabilizer	1	Pc	1	438	39263000
	9318177	9318177	Actro You runner Left, 40 kg	1	Pc	1	1,750	83024200
	9318178	9318178	Actro You runner Right, 40 kg	1	Pc	1	1,750	83024200
	9257703	9257703	Branding clip with Hettich logo (Silver)	1	Pc	1	40	39269097
BOM Code	9307361						11,109	
	<b>AvanTech You: NL-500 mm Height-187 mm (40 Kg) Full Extn. Silent</b>							
	9255054	9255054	Drawer Side Profile (Silver), Left	1	Pc	1	2,242	94039010
	9255055	9255055	Drawer Side Profile (Silver), Right	1	Pc	1	2,242	94039010
	9255809	9255809	Design Profile (Silver)	2	Pc	2	276	39169090
	9255838	9255838	Font Panel Connector for drawer side profile	2	Pc	2	1,496	83024200
	9257670	9257670	Rear Panel Connector (Silver), Left	1	Pc	1	450	83024200
	9257671	9257671	Rear Panel Connector (Silver), Right	1	Pc	1	450	83024200
	9257702	9257702	Rear Panel Stabilizer	3	Pc	3	39	39263000
	9123080	9123080	Front Stabilizer	1	Pc	1	438	39263000
	9318179	9318179	Actro You runner Left, 40 kg	1	Pc	1	1,771	83024200
	9318180	9318180	Actro You runner Right, 40 kg	1	Pc	1	1,771	83024200
	9257703	9257703	Branding clip with Hettich logo (silver)	1	Pc	1	40	39269097
BOM Code	9298409						11,215	
	<b>AvanTech You: NL-550 mm Height-187 mm (40 Kg) Full Extn. Silent</b>							
	9255056	9255056	Drawer Side Profile (Silver), Left	1	Pc	1	2,289	94039010
	9255057	9255057	Drawer Side Profile (Silver), Right	1	Pc	1	2,289	94039010
	9255810	9255810	Design Profile (Silver)	2	Pc	2	276	39169090
	9255838	9255838	Font Panel Connector for drawer side profile	2	Pc	2	1,496	83024200
	9257670	9257670	Rear Panel Connector (Silver), Left	1	Pc	1	450	83024200
	9257671	9257671	Rear Panel Connector (Silver), Right	1	Pc	1	450	83024200
	9257702	9257702	Rear Panel Stabilizer	3	Pc	3	39	39263000
	9123080	9123080	Front Stabilizer	1	Pc	1	438	39263000
	9318181	9318181	Actro You runner Left, 40 kg	1	Pc	1	1,886	83024200
	9318182	9318182	Actro You runner Right, 40 kg	1	Pc	1	1,886	83024200
	9257703	9257703	Branding clip with Hettich logo (silver)	1	Pc	1	40	39269097
BOM Code	9307390						11,539	

# Drawer System: AvanTech YOU

- ▶ Drawer height 187mm
- ▶ Silver







Product	Article No.	SAP	Item Description	Qty.	Unit	PU	MRP	HS Code
	<b>AvanTech You: NL-450 mm Height-187 mm (70 Kg) Full Extn. Silent</b>							
	9255052	9255052	Drawer Side Profile (Silver), Left	1	Pc	1	2,210	94039010
	9255053	9255053	Drawer Side Profile (Silver), Right	1	Pc	1	2,210	94039010
	9255808	9255808	Design Profile (Silver)	2	Pc	2	276	39169090
	9255838	9255838	Front Panel Connector for drawer side profile	2	Pc	2	1,496	83024200
	9257670	9257670	Rear Panel Connector (Silver), Left	1	Pc	1	450	83024200
	9257671	9257671	Rear Panel Connector (Silver), Right	1	Pc	1	450	83024200
	9257702	9257702	Rear Panel Stabilizer	3	Pc	3	39	39263000
	9123080	9123080	Front Stabilizer	1	Pc	1	438	39263000
	9257013	9257013	Actro You runner Left, 70 kg	1	Pc	1	2,291	83024200
	9257014	9257014	Actro You runner Right, 70 kg	1	Pc	1	2,291	83024200
	9257703	9257703	Branding clip with Hettich logo ( silver)	1	Pc	1	40	39269097
BOM Code	9307364						12,191	
	<b>AvanTech You: NL-500 mm Height-187 mm (70 Kg) Full Extn. Silent</b>							
	9255054	9255054	Drawer Side Profile (Silver), Left	1	Pc	1	2,242	94039010
	9255055	9255055	Drawer Side Profile (Silver), Right	1	Pc	1	2,242	94039010
	9255809	9255809	Design Profile (Silver)	2	Pc	2	276	39169090
	9255838	9255838	Front Panel Connector for drawer side profile	2	Pc	2	1,496	83024200
	9257670	9257670	Rear Panel Connector (Silver), Left	1	Pc	1	450	83024200
	9257671	9257671	Rear Panel Connector (Silver), Right	1	Pc	1	450	83024200
	9257702	9257702	Rear Panel Stabilizer	3	Pc	3	39	39263000
	9123080	9123080	Front Stabilizer	1	Pc	1	438	39263000
	9257017	9257017	Actro You runner Left, 70 kg	1	Pc	1	2,319	83024200
	9257018	9257018	Actro You runner Right, 70 kg	1	Pc	1	2,319	83024200
	9257703	9257703	Branding clip with Hettich logo ( silver)	1	Pc	1	40	39269097
BOM-Code	9298422						12,311	
	<b>AvanTech You: NL-550 mm Height-187 mm (70 Kg) Full Extn. Silent</b>							
	9255056	9255056	Drawer Side Profile (Silver), Left	1	Pc	1	2,289	94039010
	9255057	9255057	Drawer Side Profile (Silver), Right	1	Pc	1	2,289	94039010
	9255810	9255810	Design Profile (Silver)	2	Pc	2	276	39169090
	9255838	9255838	Front Panel Connector for drawer side profile	2	Pc	2	1,496	83024200
	9257670	9257670	Rear Panel Connector (Silver), Left	1	Pc	1	450	83024200
	9257671	9257671	Rear Panel Connector (Silver), Right	1	Pc	1	450	83024200
	9257702	9257702	Rear Panel Stabilizer	3	Pc	3	39	39263000
	9123080	9123080	Front Stabilizer	1	Pc	1	438	39263000
	9257021	9257021	Actro You runner Left, 70 kg	1	Pc	1	2,438	83024200
	9257022	9257022	Actro You runner Right, 70 kg	1	Pc	1	2,438	83024200
	9257703	9257703	Branding clip with Hettich logo (silver)	1	Pc	1	40	39269097
BOM-Code	9307393						12,643	
								

# Drawer System: AvanTech YOU

- ▶ Drawer height 251 mm
- ▶ Silver





Product	Article No.	SAP	Item Description	Qty.	Unit	PU	MRP	HS Code
	<b>AvanTech You: NL-400 mm Height-251 mm (40 Kg) Full Extn. Silent</b>							
	9255068	9255068	Drawer Side Profile (Silver), Left	1	Pc	1	3,876	94039010
	9255069	9255069	Drawer Side Profile (Silver), Right	1	Pc	1	3,876	94039010
	9255807	9255807	Design Profile (Silver)	2	Pc	2	292	39169090
	9255838	9255838	front Panel Connector for drawer side profile	2	Pc	2	1,496	83024200
	9257672	9257672	Rear Panel Connector (Silver), Left	1	Pc	1	667	83024200
	9257673	9257673	Rear Panel Connector (Silver), Right	1	Pc	1	667	83024200
	9257702	9257702	Rear Panel Stabilizer	3	Pc	3	39	39263000
	9123080	9123080	Front Stabilizer	1	Pc	1	438	39263000
	9318175	9318175	Actro You runner Left, 40 kg	1	Pc	1	1,715	83024200
	9318176	9318176	Actro You runner Right, 40 kg	1	Pc	1	1,715	83024200
	9257703	9257703	Branding clip with Hettich logo (Silver)	1	Pc	1	40	39269097
	9257887	9257887	Drawer front connector side profile, stabiliser	2	Pc	2	140	39269097
	BOM Code	9308046						14,961
	<b>AvanTech You: NL-450 mm Height-251 mm (40 Kg) Full Extn. Silent</b>							
	9255070	9255070	Drawer Side Profile (Silver), Left	1	Pc	1	3,740	94039010
	9255071	9255071	Drawer Side Profile (Silver), Right	1	Pc	1	3,740	94039010
	9255808	9255808	Design Profile (Silver)	2	Pc	2	276	39169090
	9255838	9255838	front Panel Connector for drawer side profile	2	Pc	2	1,496	83024200
	9257672	9257672	Rear Panel Connector (Silver), Left	1	Pc	1	667	83024200
	9257673	9257673	Rear Panel Connector (Silver), Right	1	Pc	1	667	83024200
	9257702	9257702	Rear Panel Stabilizer	3	Pc	3	39	39263000
	9123080	9123080	Front Stabilizer	1	Pc	1	438	39263000
	9318177	9318177	Actro You runner Left, 40 kg	1	Pc	1	1,750	83024200
	9318178	9318178	Actro You runner Right, 40 kg	1	Pc	1	1,750	83024200
	9257887	9257887	Drawer front connector side profile, stabiliser	2	Pc	2	140	39269097
	9257703	9257703	Branding clip with Hettich logo (silver)	1	Pc	1	40	39269097
	BOM Code	9307362						14,743
	<b>AvanTech You: NL-500 mm Height-251 mm (40 Kg) Full Extn. Silent</b>							
	9255072	9255072	Drawer Side Profile (Silver), Left	1	Pc	1	3,797	94039010
	9255073	9255073	Drawer Side Profile (Silver), Right	1	Pc	1	3,797	94039010
	9255809	9255809	Design Profile (Silver)	2	Pc	2	276	39169090
	9255838	9255838	front Panel Connector for drawer side profile	2	Pc	2	1,496	83024200
	9257672	9257672	Rear Panel Connector (Silver), Left	1	Pc	1	667	83024200
	9257673	9257673	Rear Panel Connector (Silver), Right	1	Pc	1	667	83024200
	9257702	9257702	Rear Panel Stabilizer	3	Pc	3	39	39263000
	9123080	9123080	Front Stabilizer	1	Pc	1	438	39263000
	9318179	9318179	Actro You runner Left, 40 kg	1	Pc	1	1,771	83024200
	9318180	9318180	Actro You runner Right, 40 kg	1	Pc	1	1,771	83024200
	9257703	9257703	Branding clip with Hettich logo (silver)	1	Pc	1	40	39269097
	9257887	9257887	Drawer front connector side profile, stabiliser	2	Pc	2	140	39269097
	BOM-Code	9298394						14,899
	<b>AvanTech You: NL-550 mm Height-251 mm (40 Kg) Full Extn. Silent</b>							
	9255074	9255074	Drawer Side Profile (Silver), Left	1	Pc	1	3,865	94039010
	9255075	9255075	Drawer Side Profile (Silver), Right	1	Pc	1	3,865	94039010
	9255810	9255810	Design Profile (Silver)	2	Pc	2	276	39169090
	9255838	9255838	front Panel Connector for drawer side profile	2	Pc	2	1,496	83024200
	9257672	9257672	Rear Panel Connector (Silver), Left	1	Pc	1	667	83024200
	9257673	9257673	Rear Panel Connector (Silver), Right	1	Pc	1	667	83024200
	9257702	9257702	Rear Panel Stabilizer	3	Pc	3	39	39263000
	9123080	9123080	Front Stabilizer	1	Pc	1	438	39263000
	9318181	9318181	Actro You runner Left, 40 kg	1	Pc	1	1,886	83024200
	9318182	9318182	Actro You runner Right, 40 kg	1	Pc	1	1,886	83024200
	9257703	9257703	Branding clip with Hettich logo (Silver)	1	Pc	1	40	39269097
	9257887	9257887	Drawer front connector side profile, stabiliser	2	Pc	2	140	39269097
	BOM-Code	9307391						15,265



# Drawer System: AvanTech YOU

- ▶ Drawer height 251 mm
- ▶ Silver



Product	Article No.	SAP	Item Description	Qty.	Unit	PU	MRP	HS Code
	<b>AvanTech You: NL-450 mm Height-251 mm (70 Kg) Full Extn. Silent</b>							
	9255070	9255070	Drawer Side Profile (Silver), Left	1	Pc	1	3,740	94039010
	9255071	9255071	Drawer Side Profile (Silver), Right	1	Pc	1	3,740	94039010
	9255808	9255808	Design Profile (Silver)	2	Pc	2	276	39169090
	9255838	9255838	front Panel Connector for drawer side profile	2	Pc	2	1,496	83024200
	9257672	9257672	Rear Panel Connector (Silver), Left	1	Pc	1	667	83024200
	9257673	9257673	Rear Panel Connector (Silver), Right	1	Pc	1	667	83024200
	9257702	9257702	Rear Panel Stabilizer	3	Pc	3	39	39263000
	9123080	9123080	Front Stabilizer	1	Pc	1	438	39263000
	9257013	9257013	Actro You runner Left, 70 kg	1	Pc	1	2,291	83024200
	9257014	9257014	Actro You runner Right, 70 kg	1	Pc	1	2,291	83024200
	9257887	9257887	Drawer front connector side profile, stabiliser	1	Pc	1	140	39269097
	9257703	9257703	Branding clip with Hettich logo (Silver)	2	Pc	2	40	39269097
	BOM Code	9307365						15,825
	<b>AvanTech You: NL-500 mm Height-251 mm (70 Kg) Full Extn. Silent</b>							
	9255072	9255072	Drawer Side Profile (Silver), Left	1	Pc	1	3,797	94039010
	9255073	9255073	Drawer Side Profile (Silver), Right	1	Pc	1	3,797	94039010
	9255809	9255809	Design Profile (Silver)	2	Pc	2	276	39169090
	9255838	9255838	front Panel Connector for drawer side profile	2	Pc	2	1,496	83024200
	9257672	9257672	Rear Panel Connector (Silver), Left	1	Pc	1	667	83024200
	9257673	9257673	Rear Panel Connector (Silver), Right	1	Pc	1	667	83024200
	9257702	9257702	Rear Panel Stabilizer	3	Pc	3	39	39263000
	9123080	9123080	Front Stabilizer	1	Pc	1	438	39263000
	9257017	9257017	Actro You runner Left, 70 kg	1	Pc	1	2,319	83024200
	9257018	9257018	Actro You runner Right, 70 kg	1	Pc	1	2,319	83024200
	9257703	9257703	Branding clip with Hettich logo (Silver)	1	Pc	1	40	39269097
	9257887	9257887	Drawer front connector side profile, stabiliser	2	Pc	2	140	39269097
	BOM-Code	9298398						15,995
	<b>AvanTech You: NL-550 mm Height-251 mm (70 Kg) Full Extn. Silent</b>							
	9255074	9255074	Drawer Side Profile (Silver), Left	1	Pc	1	3,865	94039010
	9255075	9255075	Drawer Side Profile (Silver), Right	1	Pc	1	3,865	94039010
	9255810	9255810	Design Profile (Silver)	2	Pc	2	276	39169090
	9255838	9255838	front Panel Connector for drawer side profile	2	Pc	2	1,496	83024200
	9257672	9257672	Rear Panel Connector (Silver), Left	1	Pc	1	667	83024200
	9257673	9257673	Rear Panel Connector (Silver), Right	1	Pc	1	667	83024200
	9257702	9257702	Rear Panel Stabilizer	3	Pc	3	39	39263000
	9123080	9123080	Front Stabilizer	1	Pc	1	438	39263000
	9257021	9257021	Actro You runner Left, 70 kg	1	Pc	1	2,438	83024200
	9257022	9257022	Actro You runner Right, 70 kg	1	Pc	1	2,438	83024200
	9257703	9257703	Branding clip with Hettich logo (Silver)	1	Pc	1	40	39269097
	9257887	9257887	Drawer front connector side profile, stabiliser	2	Pc	2	140	39269097
	BOM-Code	9307394						16,369

# Drawer System: AvanTech YOU

- ▶ Drawer height 187 mm, Inlay Drawer
- ▶ Silver



Product	Article No.	SAP	Item Description	Qty.	Unit	PU	MRP	HS Code
	<b>AvanTech YOU Inlay - 400 mm (40 Kg) Full Extn. Silent</b>							
	9257133	9257133	Inlay Drawer Side Profile, Left	1	Pc	1	2,290	94039910
	9257134	9257134	Inlay Drawer Side Profile, Right	1	Pc	1	2,290	94039910
	9257257	9257257	Drawer front connector for inlay drawer side profile	2	Pc	2	836	83024200
	9268677	9268677	Adapter for Inlay drawer side profile	4	Pc	4	728	39169090
	9257670	9257670	Rear Panel Connector (Silver), Left	1	Pc	1	450	83024200
	9257671	9257671	Rear Panel Connector (Silver), Right	1	Pc	1	450	83024200
	9257702	9257702	Rear Panel Stabilizer	3	Pc	3	39	39263090
	9123080	9123080	Front Stabilizer	1	Pc	1	438	39263090
	9318175	9318175	Actro You Drawer runner-40kg, Left	1	Pc	1	1,715	83024200
	9318176	9318176	Actro You Drawer runner-40kg, Right	1	Pc	1	1,715	83024200
	9257703	9257703	Branding clip with Hettich logo (Silver)	1	Pc	1	40	39269099
	BOM Code	9323660						10,991

	<b>AvanTech YOU Inlay - 450 mm (40 Kg) Full Extn. Silent</b>							
	9257135	9257135	Inlay Drawer Side Profile, Left	1	Pc	1	2,420	94039910
	9257136	9257136	Inlay Drawer Side Profile, Right	1	Pc	1	2,420	94039910
	9257257	9257257	Drawer front connector for Inlay drawer side profile	2	Pc	2	836	83024200
	9268677	9268677	Adapter for Inlay drawer side profile	4	Pc	4	728	39169090
	9257670	9257670	Rear Panel Connector (Silver), Left	1	Pc	1	450	83024200
	9257671	9257671	Rear Panel Connector (Silver), Right	1	Pc	1	450	83024200
	9257702	9257702	Rear Panel Stabilizer	3	Pc	3	39	39263090
	9123080	9123080	Front Stabilizer	1	Pc	1	438	39263090
	9318177	9318177	Actro You Drawer runner-40kg, Left	1	Pc	1	1,750	83024200
	9318178	9318178	Actro You Drawer runner-40kg, Right	1	Pc	1	1,750	83024200
	9257703	9257703	Branding clip with Hettich logo (Silver)	1	Pc	1	40	39269099
	BOM Code	9323713						11,321



	<b>AvanTech YOU Inlay - 500 mm (40 Kg) Full Extn. Silent</b>							
	9257137	9257137	Inlay Drawer Side Profile, Left	1	Pc	1	2,470	94039910
	9257138	9257138	Inlay Drawer Side Profile, Right	1	Pc	1	2,470	94039910
	9257257	9257257	Drawer front connector for Inlay drawer side profile	2	Pc	2	836	83024200
	9268677	9268677	Adapter for Inlay drawer side profile	4	Pc	4	728	39169090
	9257670	9257670	Rear Panel Connector (Silver), Left	1	Pc	1	450	83024200
	9257671	9257671	Rear Panel Connector (Silver), Right	1	Pc	1	450	83024200
	9257702	9257702	Rear Panel Stabilizer	3	Pc	3	39	39263090
	9123080	9123080	Front Stabilizer	1	Pc	1	438	39263090
	9318179	9318179	Actro You Drawer runner-40kg, Left	1	Pc	1	1,771	83024200
	9318180	9318180	Actro You Drawer runner-40kg, Right	1	Pc	1	1,771	83024200
	9257703	9257703	Branding clip with Hettich logo (Silver)	1	Pc	1	40	39269099
	BOM Code	9323719						11,463

	<b>AvanTech YOU Inlay - 550 mm (40 Kg) Full Extn. Silent</b>							
	9257139	9257139	Inlay Drawer Side Profile, Left	1	Pc	1	2,510	94039910
	9257140	9257140	Inlay Drawer Side Profile, Right	1	Pc	1	2,510	94039910
	9257257	9257257	Drawer front connector for Inlay drawer side profile	2	Pc	2	836	83024200
	9268677	9268677	Adapter for Inlay drawer side profile	4	Pc	4	728	39169090
	9257670	9257670	Rear Panel Connector (Silver), Left	1	Pc	1	450	83024200
	9257671	9257671	Rear Panel Connector (Silver), Right	1	Pc	1	450	83024200
	9257702	9257702	Rear Panel Stabilizer	3	Pc	3	39	39263090
	9123080	9123080	Front Stabilizer	1	Pc	1	438	39263090
	9318181	9318181	Actro You Drawer runner-40kg, Left	1	Pc	1	1,886	83024200
	9318182	9318182	Actro You Drawer runner-40kg, Right	1	Pc	1	1,886	83024200
	9257703	9257703	Branding clip with Hettich logo (Silver)	1	Pc	1	40	39269099
	BOM Code	9323725						11,773

# Drawer System: AvanTech YOU

- ▶ Drawer height 187 mm, Inlay Drawer & Narrow Pullout
- ▶ Silver



Product	Article No.	SAP	Item Description	Qty.	Unit	PU	MRP	HS Code
	<b>AvanTech YOU Inlay - 450 mm (70 Kg) Full Extn. Silent</b>							
	9257135	9257135	Inlay Drawer Side Profile, Left	1	Pc	1	2,420	94039910
	9257136	9257136	Inlay Drawer Side Profile, Right	1	Pc	1	2,420	94039910
	9257257	9257257	Drawer front connector for Inlay drawer side profile	2	Pc	2	836	83024200
	9268677	9268677	Adapter for Inlay drawer side profile	4	Pc	4	728	39169090
	9257670	9257670	Rear Panel Connector (Silver), Left	1	Pc	1	450	83024200
	9257671	9257671	Rear Panel Connector (Silver), Right	1	Pc	1	450	83024200
	9257702	9257702	Rear Panel Stabilizer	3	Pc	3	39	39263090
	9123080	9123080	Front Stabilizer	1	Pc	1	438	39263090
	9257013	9257013	Actro You Drawer runner-70kg, Left	1	Pc	1	2,291	83024200
	9257014	9257014	Actro You Drawer runner-70kg, Right	1	Pc	1	2,291	83024200
	9257703	9257703	Branding clip with Hettich logo (Silver)	1	Pc	1	40	39269099
	BOM Code	9323716						12,403
	<b>AvanTech YOU Inlay - 500 mm (70 Kg) Full Extn. Silent</b>							
	9257137	9257137	Inlay Drawer Side Profile, Left	1	Pc	1	2,470	94039910
	9257138	9257138	Inlay Drawer Side Profile, Right	1	Pc	1	2,470	94039910
	9257257	9257257	Drawer front connector for Inlay drawer side profile	2	Pc	2	836	83024200
	9268677	9268677	Adapter for Inlay drawer side profile	4	Pc	4	728	39169090
	9257670	9257670	Rear Panel Connector (Silver), Left	1	Pc	1	450	83024200
	9257671	9257671	Rear Panel Connector (Silver), Right	1	Pc	1	450	83024200
	9257702	9257702	Rear Panel Stabilizer	3	Pc	3	39	39263090
	9123080	9123080	Front Stabilizer	1	Pc	1	438	39263090
	9257017	9257017	Actro You Drawer runner-70kg, Left	1	Pc	1	2,319	83024200
	9257018	9257018	Actro You Drawer runner-70kg, Right	1	Pc	1	2,319	83024200
	9257703	9257703	Branding clip with Hettich logo (Silver)	1	Pc	1	40	39269099
	BOM Code	9323722						12,559
	<b>AvanTech YOU Inlay - 550 mm (70 Kg) Full Extn. Silent</b>							
	9257139	9257139	Inlay Drawer Side Profile, Left	1	Pc	1	2,510	94039910
	9257140	9257140	Inlay Drawer Side Profile, Right	1	Pc	1	2,510	94039910
	9257257	9257257	Drawer front connector for Inlay drawer side profile	2	Pc	2	836	83024200
	9268677	9268677	Adapter for Inlay drawer side profile	4	Pc	4	728	39169090
	9257670	9257670	Rear Panel Connector (Silver), Left	1	Pc	1	450	83024200
	9257671	9257671	Rear Panel Connector (Silver), Right	1	Pc	1	450	83024200
	9257702	9257702	Rear Panel Stabilizer	3	Pc	3	39	39263090
	9123080	9123080	Front Stabilizer	1	Pc	1	438	39263090
	9257021	9257021	Actro You Drawer runner-70kg, Left	1	Pc	1	2,438	83024200
	9257022	9257022	Actro You Drawer runner-70kg, Right	1	Pc	1	2,438	83024200
	9257703	9257703	Branding clip with Hettich logo (Silver)	1	Pc	1	40	39269099
	BOM Code	9323728						12,877
	<b>AvanTech You Narrow Pullout units NL 500 mm</b>							
	9332320	9332320	AvanTech You Narrow Pullout (Height 101+187 mm)/ Silver/ 20 Kg/ Depth 500 mm	1	Set	1	15,532	94039010
	9332327	9332327	AvanTech You- Narrow Pullout(Height 101+251 mm)/ Silver/ 20 Kg/ Depth 500 mm	1	Set	1	19,216	94039010

# Drawer System: AvanTech YOU

- ▶ Drawer height 101 /187 mm
- ▶ White





Product	Article No.	SAP	Item Description	Qty.	Unit	PU	MRP	HS Code
	<b>AvanTech You: NL-500 mm Height-101 mm (40 Kg) Full Extn. Silent</b>							
	9255098	9255098	Drawer Side Profile (White), Left	1	Pc	1	1,518	94039010
	9255099	9255099	Drawer Side Profile (White), Right	1	Pc	1	1,518	94039010
	9255818	9255818	Design Profile (White)	2	Pc	2	276	39169090
	9255835	9255835	Font Panel Connector for drawer side profile	2	Pc	2	806	83024200
	9257678	9257678	Rear Panel Connector (White), Left	1	Pc	1	305	83024200
	9257679	9257679	Rear Panel Connector (White), Right	1	Pc	1	305	83024200
	9257702	9257702	Rear Panel Stabilizer	3	Pc	3	39	39263000
	9123080	9123080	Front Stabilizer	1	Pc	1	438	39263000
	9318179	9318179	Actro You runner (Left), 40 kg	1	Pc	1	1,771	83024200
	9318180	9318180	Actro You runner (Right), 40 kg	1	Pc	1	1,771	83024200
	9257704	9257704	Branding clip with Hettich logo (White)	1	Pc	1	40	39269097
BOM-Code	9298404					8,787		
	<b>AvanTech You: NL-500 mm Height-101 mm (70 Kg) Full Extn. Silent</b>							
	9255098	9255098	Drawer Side Profile (White), Left	1	Pc	1	1,518	94039010
	9255099	9255099	Drawer Side Profile (White), Right	1	Pc	1	1,518	94039010
	9255818	9255818	Design Profile (White)	2	Pc	2	276	39169090
	9255835	9255835	Font Panel Connector for drawer side profile	2	Pc	2	806	83024200
	9257678	9257678	Rear Panel Connector (White), Left	1	Pc	1	305	83024200
	9257679	9257679	Rear Panel Connector (White), Right	1	Pc	1	305	83024200
	9257702	9257702	Rear Panel Stabilizer	3	Pc	3	39	39263000
	9123080	9123080	Front Stabilizer	1	Pc	1	438	39263000
	9257017	9257017	Actro You runner (Left), 70 kg	1	Pc	1	2,319	83024200
	9257018	9257018	Actro You runner (Right), 70 kg	1	Pc	1	2,319	83024200
	9257704	9257704	Branding clip with Hettich logo (White)	1	Pc	1	40	39269097
BOM-Code	9298407					9,883		
	<b>AvanTech You: NL-500 mm Height-187 mm (40 Kg) Full Extn. Silent</b>							
	9255134	9255134	Drawer Side Profile (White), Left	1	Pc	1	2,242	94039010
	9255135	9255135	Drawer Side Profile (White), Right	1	Pc	1	2,242	94039010
	9255818	9255818	Design Profile (White)	2	Pc	2	276	39169090
	9255838	9255838	Font Panel Connector for drawer side profile	2	Pc	2	1,496	83024200
	9257682	9257682	Rear Panel Connector (White), Left	1	Pc	1	450	83024200
	9257683	9257683	Rear Panel Connector (White), Right	1	Pc	1	450	83024200
	9257702	9257702	Rear Panel Stabilizer	3	Pc	3	39	39263000
	9123080	9123080	Front Stabilizer	1	Pc	1	438	39263000
	9318179	9318179	Actro You runner Left, 40 kg	1	Pc	1	1,771	83024200
	9318180	9318180	Actro You runner Right, 40 kg	1	Pc	1	1,771	83024200
	9257704	9257704	Branding clip with Hettich logo (White)	1	Pc	1	40	39269097
BOM-Code	9298410					11,215		



# Drawer System: AvanTech YOU

- ▶ Drawer height 187 / 251 mm
- ▶ White



Product	Article No.	SAP	Item Description	Qty.	Unit	PU	MRP	HS Code
<b>AvanTech You: NL-500 mm Height-187 mm (70 Kg) Full Extn. Silent</b>								
	9255134	9255134	Drawer Side Profile (White), Left	1	Pc	1	2,242	94039010
	9255135	9255135	Drawer Side Profile (White), Right	1	Pc	1	2,242	94039010
	9255818	9255818	Design Profile (White)	2	Pc	2	276	39169090
	9255838	9255838	Font Panel Connector for drawer side profile	2	Pc	2	1,496	83024200
	9257682	9257682	Rear Panel Connector (White), Left	1	Pc	1	450	83024200
	9257683	9257683	Rear Panel Connector (White), Right	1	Pc	1	450	83024200
	9257702	9257702	Rear Panel Stabilizer	3	Pc	3	39	39263000
	9123080	9123080	Front Stabilizer	1	Pc	1	438	39263000
	9257017	9257017	Actro You runner Left, 70 kg	1	Pc	1	2,319	83024200
	9257018	9257018	Actro You runner Right, 70 kg	1	Pc	1	2,319	83024200
	9257704	9257704	Branding clip with Hettich logo (White)	1	Pc	1	40	39269097
BOM-Code	9298423						12,311	
<b>AvanTech You: NL-500 mm Height-251 mm (40 Kg) Full Extn. Silent</b>								
	9255152	9255152	Drawer Side Profile (White), Left	1	Pc	1	3,797	94039010
	9255153	9255153	Drawer Side Profile (White), Right	1	Pc	1	3,797	94039010
	9255818	9255818	Design Profile (White)	2	Pc	2	276	39169090
	9255838	9255838	Font Panel Connector for drawer side profile	2	Pc	2	1,496	83024200
	9257684	9257684	Rear Panel Connector (White), Left	1	Pc	1	667	83024200
	9257685	9257685	Rear Panel Connector (White), Right	1	Pc	1	667	83024200
	9257702	9257702	Rear Panel Stabilizer	3	Pc	3	39	39263000
	9123080	9123080	Front Stabilizer	1	Pc	1	438	39263000
	9318179	9318179	Actro You runner Left, 40 kg	1	Pc	1	1,771	83024200
	9318180	9318180	Actro You runner Right, 40 kg	1	Pc	1	1,771	83024200
	9257704	9257704	Branding clip with Hettich logo white	1	Pc	1	40	39269097
9257887	9257887	Drawer front connector side profile, stabiliser	2	Pc	2	140	39269097	
BOM-Code	9298395						14,899	
<b>AvanTech You: NL-500 mm Height-251 mm (70 Kg) Full Extn. Silent</b>								
	9255152	9255152	Drawer Side Profile (White), Left	1	Pc	1	3,797	94039010
	9255153	9255153	Drawer Side Profile (White), Right	1	Pc	1	3,797	94039010
	9255818	9255818	Design Profile (White)	2	Pc	2	276	39169090
	9255838	9255838	Font Panel Connector for drawer side profile	2	Pc	2	1,496	83024200
	9257684	9257684	Rear Panel Connector (White), Left	1	Pc	1	667	83024200
	9257685	9257685	Rear Panel Connector (White), Right	1	Pc	1	667	83024200
	9257702	9257702	Rear Panel Stabilizer	3	Pc	3	39	39263000
	9123080	9123080	Front Stabilizer	1	Pc	1	438	39263000
	9257017	9257017	Actro You runner Left, 70 kg	1	Pc	1	2,319	83024200
	9257018	9257018	Actro You runner Right, 70 kg	1	Pc	1	2,319	83024200
	9257704	9257704	Branding clip with Hettich Logo White	1	Pc	1	40	39269097
9257887	9257887	Drawer front connector side profile, stabiliser	2	Pc	2	140	39269097	
BOM-Code	9298400						15,995	

# Drawer System: AvanTech YOU

- ▶ Drawer height 187 mm, Inlay Drawer & Narrow Pullout
- ▶ White



Product	Article No.	SAP	Item Description	Qty.	Unit	PU	MRP	HS Code
	<b>AvanTech YOU Inlay - 500 mm (40 Kg) Full Extn. Silent</b>							
	9257151	9257151	Inlay Drawer Side Profile, Left	1	Pc	1	2,470	94039910
	9257152	9257152	Inlay Drawer Side Profile, Right	1	Pc	1	2,470	94039910
	9257257	9257257	Drawer front connector for Inlay drawer side profile	2	Pc	2	836	83024200
	9268677	9268677	Adapter for Inlay drawer side profile	4	Pc	4	728	39169090
	9257682	9257682	Rear Panel Connector (White), Left	1	Pc	1	450	83024200
	9257683	9257683	Rear Panel Connector (White), Right	1	Pc	1	450	83024200
	9257702	9257702	Rear Panel Stabilizer	3	Pc	3	39	39263090
	9123080	9123080	Front Stabilizer	1	Pc	1	438	39263090
	9318179	9318179	Actro You Drawer runner-40kg, Left	1	Pc	1	1,771	83024200
	9318180	9318180	Actro You Drawer runner-40kg, Right	1	Pc	1	1,771	83024200
	9257704	9257704	Branding clip with Hettich Logo (White)	1	Pc	1	40	39269099
	BOM Code	9323721						11,463
	<b>AvanTech YOU Inlay - 500 mm (70 Kg) Full Extn. Silent</b>							
	9257151	9257151	Inlay Drawer Side Profile, Left	1	Pc	1	2,470	94039910
	9257152	9257152	Inlay Drawer Side Profile, Right	1	Pc	1	2,470	94039910
	9257257	9257257	Drawer front connector for Inlay drawer side profile	2	Pc	2	836	83024200
	9268677	9268677	Adapter for Inlay drawer side profile	4	Pc	4	728	39169090
	9257682	9257682	Rear Panel Connector (White), Left	1	Pc	1	450	83024200
	9257683	9257683	Rear Panel Connector (White), Right	1	Pc	1	450	83024200
	9257702	9257702	Rear Panel Stabilizer	3	Pc	3	39	39263090
	9123080	9123080	Front Stabilizer	1	Pc	1	438	39263090
	9257017	9257017	Actro You Drawer runner-70kg, Left	1	Pc	1	2,319	83024200
	9257018	9257018	Actro You Drawer runner-70kg, Right	1	Pc	1	2,319	83024200
	9257704	9257704	Branding clip with Hettich Logo (White)	1	Pc	1	40	39269099
	BOM Code	9323724						12,559
	<b>AvanTech You Narrow Pullout units NL 500 mm</b>							
	9332324	9332324	AvanTech You Narrow Pullout (Height 101+187 mm)/ White/ 20 Kg/ Depth 500 mm	1	Set	1	15,532	94039010
9332329	9332329	AvanTech You- Narrow Pullout (Height 101+251 mm)/ White / 20 Kg/ Depth 500 mm	1	Set	1	19,216	94039010	

# Drawer System: AvanTech YOU

- ▶ Drawer height 101 mm
- ▶ Anthracite



Product	Article No.	SAP	Item Description	Qty.	Unit	PU	MRP	HS Code
	<b>AvanTech You: NL-400 mm Height-101 mm (40 Kg) Full Extn. Silent</b>							
	9255174	9255174	Drawer Side Profile (Anthracite), Left	1	Pc	1	1,342	94039010
	9255175	9255175	Drawer Side Profile (Anthracite), Right	1	Pc	1	1,342	94039010
	9255825	9255825	Design Profile (Anthracite)	2	Pc	2	292	39169090
	9255835	9255835	Font Panel Connector for drawer side profile	2	Pc	2	806	83024200
	9257690	9257690	Rear Panel Connector (Anthracite), Left	1	Pc	1	305	83024200
	9257691	9257691	Rear Panel Connector (Anthracite), Right	1	Pc	1	305	83024200
	9257702	9257702	Rear Panel Stabilizer	3	Pc	3	39	39263000
	9123080	9123080	Front Stabilizer	1	Pc	1	438	39263000
	9318175	9318175	Actro You runner (Left), 40 kg	1	Pc	1	1,715	83024200
	9318176	9318176	Actro You runner (Right), 40 kg	1	Pc	1	1,715	83024200
	9257705	9257705	Branding clip with Hettich Logo Anthracite	1	Pc	1	40	39269097
BOM Code	9308047						8,339	
	<b>AvanTech You: NL-450 mm Height-101 mm (40 Kg) Full Extn. Silent</b>							
	9255176	9255176	Drawer Side Profile (Anthracite), Left	1	Pc	1	1,485	94039010
	9255177	9255177	Drawer Side Profile (Anthracite), Right	1	Pc	1	1,485	94039010
	9255826	9255826	Design Profile (Anthracite)	2	Pc	2	276	39169090
	9255835	9255835	Font Panel Connector for drawer side profile	2	Pc	2	806	83024200
	9257690	9257690	Rear Panel Connector Anthracite), Left	1	Pc	1	305	83024200
	9257691	9257691	Rear Panel Connector (Anthracite), Right	1	Pc	1	305	83024200
	9257702	9257702	Rear Panel Stabilizer	3	Pc	3	39	39263000
	9123080	9123080	Front Stabilizer	1	Pc	1	438	39263000
	9318177	9318177	Actro You runner (Left), 40 kg	1	Pc	1	1,750	83024200
	9318178	9318178	Actro You runner (Right), 40 kg	1	Pc	1	1,750	83024200
	9257705	9257705	Branding clip with Hettich logo (Anthracite)	1	Pc	1	40	39269097
BOM Code	9307366						8,679	
	<b>AvanTech You: NL-500 mm Height-101 mm (40 Kg) Full Extn. Silent</b>							
	9255178	9255178	Drawer Side Profile (Anthracite), Left	1	Pc	1	1,518	94039010
	9255179	9255179	Drawer Side Profile (Anthracite), Right	1	Pc	1	1,518	94039010
	9255827	9255827	Design Profile (Anthracite)	2	Pc	2	276	39169090
	9255835	9255835	Font Panel Connector for drawer side profile	2	Pc	2	806	83024200
	9257690	9257690	Rear Panel Connector Anthracite), Left	1	Pc	1	305	83024200
	9257691	9257691	Rear Panel Connector (Anthracite), Right	1	Pc	1	305	83024200
	9257702	9257702	Rear Panel Stabilizer	3	Pc	3	39	39263000
	9123080	9123080	Front Stabilizer	1	Pc	1	438	39263000
	9318179	9318179	Actro You runner (Left), 40 kg	1	Pc	1	1,771	83024200
	9318180	9318180	Actro You runner (Right), 40 kg	1	Pc	1	1,771	83024200
	9257705	9257705	Branding clip with Hettich Logo Anthracite	1	Pc	1	40	39269097
BOM-Code	9298405						8,787	
	<b>AvanTech You: NL-550 mm Height-101 mm (40 Kg) Full Extn. Silent</b>							
	9255180	9255180	Drawer Side Profile (Anthracite), Left	1	Pc	1	1,541	94039010
	9255181	9255181	Drawer Side Profile (Anthracite), Right	1	Pc	1	1,541	94039010
	9255828	9255828	Design Profile (Anthracite)	2	Pc	2	276	39169090
	9255835	9255835	Font Panel Connector for drawer side profile	2	Pc	2	806	83024200
	9257690	9257690	Rear Panel Connector (Anthracite), Left	1	Pc	1	305	83024200
	9257691	9257691	Rear Panel Connector (Anthracite), Right	1	Pc	1	305	83024200
	9257702	9257702	Rear Panel Stabilizer	3	Pc	3	39	39263000
	9123080	9123080	Front Stabilizer	1	Pc	1	438	39263000
	9318181	9318181	Actro You runner (Left), 40 kg	1	Pc	1	1,886	83024200
	9318182	9318182	Actro You runner (Right), 40 kg	1	Pc	1	1,886	83024200
	9257705	9257705	Branding clip with Hettich logo (Anthracite)	1	Pc	1	40	39269097
BOM-Code	9307395						9,063	

# Drawer System: AvanTech YOU

- ▶ Drawer height 101 mm
- ▶ Anthracite



Product	Article No.	SAP	Item Description	Qty.	Unit	PU	MRP	HS Code
	<b>AvanTech You: NL-450 mm Height-101 mm (70 Kg) Full Extn. Silent</b>							
	9255176	9255176	Drawer Side Profile (Anthracite), Left	1	Pc	1	1,485	94039010
	9255177	9255177	Drawer Side Profile (Anthracite), Right	1	Pc	1	1,485	94039010
	9255826	9255826	Design Profile (Anthracite)	2	Pc	2	276	39169090
	9255835	9255835	Font Panel Connector for drawer side profile	2	Pc	2	806	83024200
	9257690	9257690	Rear Panel Connector (Anthracite), Left	1	Pc	1	305	83024200
	9257691	9257691	Rear Panel Connector (Anthracite), Right	1	Pc	1	305	83024200
	9257702	9257702	Rear Panel Stabilizer	3	Pc	3	39	39263000
	9123080	9123080	Front Stabilizer	1	Pc	1	438	39263000
	9257013	9257013	Actro You runner (Left), 70 kg	1	Pc	1	2,291	83024200
	9257014	9257014	Actro You runner (Right), 70 kg	1	Pc	1	2,291	83024200
9257705	9257705	Branding clip with Hettich logo (Anthracite)	1	Pc	1	40	39269097	
BOM Code	9307369						9,761	
	<b>AvanTech You: NL-500 mm Height-101 mm (70 Kg) Full Extn. Silent</b>							
	9255178	9255178	Drawer Side Profile (Anthracite), Left	1	Pc	1	1,518	94039010
	9255179	9255179	Drawer Side Profile (Anthracite), Right	1	Pc	1	1,518	94039010
	9255827	9255827	Design Profile (Anthracite)	2	Pc	2	276	39169090
	9255835	9255835	Font Panel Connector for drawer side profile	2	Pc	2	806	83024200
	9257690	9257690	Rear Panel Connector (Anthracite), Left	1	Pc	1	305	83024200
	9257691	9257691	Rear Panel Connector (Anthracite), Right	1	Pc	1	305	83024200
	9257702	9257702	Rear Panel Stabilizer	3	Pc	3	39	39263000
	9123080	9123080	Front Stabilizer	1	Pc	1	438	39263000
	9257017	9257017	Actro You runner (Left), 70 kg	1	Pc	1	2,319	83024200
	9257018	9257018	Actro You runner (Right), 70 kg	1	Pc	1	2,319	83024200
9257705	9257705	Branding clip with Hettich logo (Anthracite)	1	Pc	1	40	39269097	
BOM-Code	9298408						9,883	
	<b>AvanTech You: NL-550 mm Height-101 mm (70 Kg) Full Extn. Silent</b>							
	9255180	9255180	Drawer Side Profile (Anthracite), Left	1	Pc	1	1,541	94039010
	9255181	9255181	Drawer Side Profile (Anthracite), Right	1	Pc	1	1,541	94039010
	9255828	9255828	Design Profile (Anthracite)	2	Pc	2	276	39169090
	9255835	9255835	Font Panel Connector for drawer side profile	2	Pc	2	806	83024200
	9257690	9257690	Rear Panel Connector (Anthracite), Left	1	Pc	1	305	83024200
	9257691	9257691	Rear Panel Connector (Anthracite), Right	1	Pc	1	305	83024200
	9257702	9257702	Rear Panel Stabilizer	3	Pc	3	39	39263000
	9123080	9123080	Front Stabilizer	1	Pc	1	438	39263000
	9257021	9257021	Actro You runner (Left), 70 kg	1	Pc	1	2,438	83024200
	9257022	9257022	Actro You runner (Right), 70 kg	1	Pc	1	2,438	83024200
9257705	9257705	Branding clip with Hettich logo (Anthracite)	1	Pc	1	40	39269097	
BOM-Code	9307399						10,167	









# Drawer System: AvanTech YOU

- ▶ Drawer height 187 mm
- ▶ Anthracite



Product	Article No.	SAP	Item Description	Qty.	Unit	PU	MRP	HS Code
	<b>AvanTech You: NL-400 mm Height-187 mm (40 Kg) Full Extn. Silent</b>							
	9255210	9255210	Drawer Side Profile (Anthracite), Left	1	Pc	1	2,128	94039010
	9255211	9255211	Drawer Side Profile (Anthracite), Right	1	Pc	1	2,128	94039010
	9255825	9255825	Design Profile (Anthracite)	2	Pc	2	292	39169090
	9255838	9255838	front Panel Connector for drawer side profile	2	Pc	2	1,496	83024200
	9257694	9257694	Rear Panel Connector (Anthracite), Left	1	Pc	1	450	83024200
	9257695	9257695	Rear Panel Connector (Anthracite), Right	1	Pc	1	450	83024200
	9257702	9257702	Rear Panel Stabilizer	3	Pc	3	39	39263000
	9123080	9123080	Front Stabilizer	1	Pc	1	438	39263000
	9318175	9318175	Actro You runner Left, 40 kg	1	Pc	1	1,715	83024200
	9318176	9318176	Actro You runner Right, 40 kg	1	Pc	1	1,715	83024200
	9257705	9257705	Branding clip with Hettich Logo Anthracite	1	Pc	1	40	39269097
BOM Code	9308048						10,891	
	<b>AvanTech You: NL-450 mm Height-187 mm (40 Kg) Full Extn. Silent</b>							
	9255212	9255212	Drawer Side Profile (Anthracite), Left	1	Pc	1	2,210	94039010
	9255213	9255213	Drawer Side Profile (Anthracite), Right	1	Pc	1	2,210	94039010
	9255826	9255826	Design Profile (Anthracite)	2	Pc	2	276	39169090
	9255838	9255838	front Panel Connector for drawer side profile	2	Pc	2	1,496	83024200
	9257694	9257694	Rear Panel Connector (Anthracite), Left	1	Pc	1	450	83024200
	9257695	9257695	Rear Panel Connector (Anthracite), Right	1	Pc	1	450	83024200
	9257702	9257702	Rear Panel Stabilizer	3	Pc	3	39	39263000
	9123080	9123080	Front Stabilizer	1	Pc	1	438	39263000
	9318177	9318177	Actro You runner Left, 40 kg	1	Pc	1	1,750	83024200
	9318178	9318178	Actro You runner Right, 40 kg	1	Pc	1	1,750	83024200
	9257705	9257705	Branding clip with Hettich logo (Anthracite)	1	Pc	1	40	39269097
BOM Code	9307367						11,109	
	<b>AvanTech You: NL-500 mm Height-187 mm (40 Kg) Full Extn. Silent</b>							
	9255214	9255214	Drawer Side Profile (Anthracite), Left	1	Pc	1	2,242	94039010
	9255215	9255215	Drawer Side Profile (Anthracite), Right	1	Pc	1	2,242	94039010
	9255827	9255827	Design Profile (Anthracite)	2	Pc	2	276	39169090
	9255838	9255838	front Panel Connector for drawer side profile	2	Pc	2	1,496	83024200
	9257694	9257694	Rear Panel Connector (Anthracite), Left	1	Pc	1	450	83024200
	9257695	9257695	Rear Panel Connector (Anthracite), Right	1	Pc	1	450	83024200
	9257702	9257702	Rear Panel Stabilizer	3	Pc	3	39	39263000
	9123080	9123080	Front Stabilizer	1	Pc	1	438	39263000
	9318179	9318179	Actro You runner Left, 40 kg	1	Pc	1	1,771	83024200
	9318180	9318180	Actro You runner Right, 40 kg	1	Pc	1	1,771	83024200
	9257705	9257705	Branding clip with Hettich logo (Anthracite)	1	Pc	1	40	39269097
BOM Code	9298421						11,215	
	<b>AvanTech You: NL-550 mm Height-187 mm (40 Kg) Full Extn. Silent</b>							
	9255216	9255216	Drawer Side Profile (Anthracite), Left	1	Pc	1	2,289	94039010
	9255217	9255217	Drawer Side Profile (Anthracite), Right	1	Pc	1	2,289	94039010
	9255828	9255828	Design Profile (Anthracite)	2	Pc	2	276	39169090
	9255838	9255838	front Panel Connector for drawer side profile	2	Pc	2	1,496	83024200
	9257694	9257694	Rear Panel Connector (Anthracite), Left	1	Pc	1	450	83024200
	9257695	9257695	Rear Panel Connector (Anthracite), Right	1	Pc	1	450	83024200
	9257702	9257702	Rear Panel Stabilizer	3	Pc	3	39	39263000
	9123080	9123080	Front Stabilizer	1	Pc	1	438	39263000
	9318181	9318181	Actro You runner Left, 40 kg	1	Pc	1	1,886	83024200
	9318182	9318182	Actro You runner Right, 40 kg	1	Pc	1	1,886	83024200
	9257705	9257705	Branding clip with Hettich logo (Anthracite)	1	Pc	1	40	39269097
BOM Code	9307396						11,539	

# Drawer System: AvanTech YOU

- ▶ Drawer height 187 mm
- ▶ Anthracite





Product	Article No.	SAP	Item Description	Qty.	Unit	PU	MRP	HS Code
	<b>AvanTech You: NL-450 mm Height-187 mm (70 Kg) Full Extn. Silent</b>							
	9255212	9255212	Drawer Side Profile (Anthracite), Left	1	Pc	1	2,210	94039010
	9255213	9255213	Drawer Side Profile (Anthracite), Right	1	Pc	1	2,210	94039010
	9255826	9255826	Design Profile (Anthracite)	2	Pc	2	276	39169090
	9255838	9255838	front Panel Connector for drawer side profile	2	Pc	2	1,496	83024200
	9257694	9257694	Rear Panel Connector (Anthracite), Left	1	Pc	1	450	83024200
	9257695	9257695	Rear Panel Connector (Anthracite), Right	1	Pc	1	450	83024200
	9257702	9257702	Rear Panel Stabilizer	3	Pc	3	39	39263000
	9123080	9123080	Front Stabilizer	1	Pc	1	438	39263000
	9257013	9257013	Actro You runner Left, 70 kg	1	Pc	1	2,291	83024200
	9257014	9257014	Actro You runner Right, 70 kg	1	Pc	1	2,291	83024200
	9257705	9257705	Branding clip with Hettich logo (Anthracite)	1	Pc	1	40	39269097
BOM Code	9307370						12,191	
	<b>AvanTech You: NL-500 mm Height- 187 mm (70 Kg) Full Extn. Silent</b>							
	9255214	9255214	Drawer Side Profile (Anthracite), Left	1	Pc	1	2,242	94039010
	9255215	9255215	Drawer Side Profile (Anthracite), Right	1	Pc	1	2,242	94039010
	9255827	9255827	Design Profile (Anthracite)	2	Pc	2	276	39169090
	9255838	9255838	front Panel Connector for drawer side profile	2	Pc	2	1,496	83024200
	9257694	9257694	Rear Panel Connector (Anthracite), Left	1	Pc	1	450	83024200
	9257695	9257695	Rear Panel Connector (Anthracite), Right	1	Pc	1	450	83024200
	9257702	9257702	Rear Panel Stabilizer	3	Pc	3	39	39263000
	9123080	9123080	Front Stabilizer	1	Pc	1	438	39263000
	9257017	9257017	Actro You runner Left, 70 kg	1	Pc	1	2,319	83024200
	9257018	9257018	Actro You runner Right, 70 kg	1	Pc	1	2,319	83024200
	9257705	9257705	Branding clip with Hettich logo (Anthracite)	1	Pc	1	40	39269097
BOM-Code	9298424						12,311	
	<b>AvanTech You: NL-550 mm Height- 187 mm (70 Kg) Full Extn. Silent</b>							
	9255216	9255216	Drawer Side Profile (Anthracite), Left	1	Pc	1	2,289	94039010
	9255217	9255217	Drawer Side Profile (Anthracite), Right	1	Pc	1	2,289	94039010
	9255828	9255828	Design Profile (Anthracite)	2	Pc	2	276	39169090
	9255838	9255838	front Panel Connector for drawer side profile	2	Pc	2	1,496	83024200
	9257694	9257694	Rear Panel Connector (Anthracite), Left	1	Pc	1	450	83024200
	9257695	9257695	Rear Panel Connector (Anthracite), Right	1	Pc	1	450	83024200
	9257702	9257702	Rear Panel Stabilizer	3	Pc	3	39	39263000
	9123080	9123080	Front Stabilizer	1	Pc	1	438	39263000
	9257021	9257021	Actro You runner Left, 70 kg	1	Pc	1	2,438	83024200
	9257022	9257022	Actro You runner Right, 70 kg	1	Pc	1	2,438	83024200
	9257705	9257705	Branding clip with Hettich logo (Anthracite)	1	Pc	1	40	39269097
BOM-Code	9307400						12,643	



# Drawer System: AvanTech YOU

- ▶ Drawer height 251 mm
- ▶ Anthracite





Product	Article No.	SAP	Item Description	Qty.	Unit	PU	MRP	HS Code
	<b>AvanTech You: NL-400 mm Height-251 mm (40 Kg) Full Extn. Silent</b>							
	9255228	9255228	Drawer Side Profile (Anthracite), Left	1	Pc	1	3,876	94039010
	9255229	9255229	Drawer Side Profile (Anthracite), Right	1	Pc	1	3,876	94039010
	9255825	9255825	Design Profile (Anthracite)	2	Pc	2	292	39169090
	9255838	9255838	front Panel Connector for drawer side profile	2	Pc	2	1,496	83024200
	9257696	9257696	Rear Panel Connector (Anthracite), Left	1	Pc	1	667	83024200
	9257697	9257697	Rear Panel Connector (Anthracite), Right	1	Pc	1	667	83024200
	9257702	9257702	Rear Panel Stabilizer	3	Pc	3	39	39263000
	9123080	9123080	Front Stabilizer	1	Pc	1	438	39263000
	9318175	9318175	Actro You runner Left, 40 kg	1	Pc	1	1,715	83024200
	9318176	9318176	Actro You runner Right, 40 kg	1	Pc	1	1,715	83024200
	9257705	9257705	Branding clip with Hettich Logo Anthracite	1	Pc	1	40	39269097
	9257887	9257887	Drawer front connector side profile, stabiliser	2	Pc	2	140	39269097
	BOM Code	9308049						14,961
	<b>AvanTech You: NL-450 mm Height-251 mm (40 Kg) Full Extn. Silent</b>							
	9255230	9255230	Drawer Side Profile (Anthracite), Left	1	Pc	1	3,740	94039010
	9255231	9255231	Drawer Side Profile (Anthracite), Right	1	Pc	1	3,740	94039010
	9255826	9255826	Design Profile (Anthracite)	2	Pc	2	276	39169090
	9255838	9255838	front Panel Connector for drawer side profile	2	Pc	2	1,496	83024200
	9257696	9257696	Rear Panel Connector (Anthracite), Left	1	Pc	1	667	83024200
	9257697	9257697	Rear Panel Connector (Anthracite), Right	1	Pc	1	667	83024200
	9257702	9257702	Rear Panel Stabilizer	3	Pc	3	39	39263000
	9123080	9123080	Front Stabilizer	1	Pc	1	438	39263000
	9318177	9318177	Actro You runner Left, 40 kg	1	Pc	1	1,750	83024200
	9318178	9318178	Actro You runner Right, 40 kg	1	Pc	1	1,750	83024200
	9257705	9257705	Branding clip with Hettich Logo Anthracite	1	Pc	1	40	39269097
	9257887	9257887	Drawer front connector side profile, stabiliser	2	Pc	2	140	39269097
	BOM Code	9307368						14,743
	<b>AvanTech You: NL-500 mm Height-251 mm (40 Kg) Full Extn. Silent</b>							
	9255232	9255232	Drawer Side Profile (Anthracite), Left	1	Pc	1	3,797	94039010
	9255233	9255233	Drawer Side Profile (Anthracite), Right	1	Pc	1	3,797	94039010
	9255827	9255827	Design Profile (Anthracite)	2	Pc	2	276	39169090
	9255838	9255838	front Panel Connector for drawer side profile	2	Pc	2	1,496	83024200
	9257696	9257696	Rear Panel Connector (Anthracite), Left	1	Pc	1	667	83024200
	9257697	9257697	Rear Panel Connector (Anthracite), Right	1	Pc	1	667	83024200
	9257702	9257702	Rear Panel Stabilizer	3	Pc	3	39	39263000
	9123080	9123080	Front Stabilizer	1	Pc	1	438	39263000
	9318179	9318179	Actro You runner Left, 40 kg	1	Pc	1	1,771	83024200
	9318180	9318180	Actro You runner Right, 40 kg	1	Pc	1	1,771	83024200
	9257705	9257705	Branding clip with Hettich Logo Anthracite	1	Pc	1	40	39269097
	9257887	9257887	Drawer front connector side profile, stabiliser	2	Pc	2	140	39269097
	BOM-Code	9298396						14,899
	<b>AvanTech You: NL-550 mm Height-251 mm (40 Kg) Full Extn. Silent</b>							
	9255234	9255234	Drawer Side Profile (Anthracite), Left	1	Pc	1	3,865	94039010
	9255235	9255235	Drawer Side Profile (Anthracite), Right	1	Pc	1	3,865	94039010
	9255828	9255828	Design Profile (Anthracite)	2	Pc	2	276	39169090
	9255838	9255838	front Panel Connector for drawer side profile	2	Pc	2	1,496	83024200
	9257696	9257696	Rear Panel Connector (Anthracite), Left	1	Pc	1	667	83024200
	9257697	9257697	Rear Panel Connector (Anthracite), Right	1	Pc	1	667	83024200
	9257702	9257702	Rear Panel Stabilizer	3	Pc	3	39	39263000
	9123080	9123080	Front Stabilizer	1	Pc	1	438	39263000
	9318181	9318181	Actro You runner Left, 40 kg	1	Pc	1	1,886	83024200
	9318182	9318182	Actro You runner Right, 40 kg	1	Pc	1	1,886	83024200
	9257705	9257705	Branding clip with Hettich Logo Anthracite	1	Pc	1	40	39269097
	9257887	9257887	Drawer front connector side profile, stabiliser	2	Pc	2	140	39269097
	BOM-Code	9307397						15,265

# Drawer System: AvanTech YOU

- ▶ Drawer height 251 mm
- ▶ Anthracite



Product	Article No.	SAP	Item Description	Qty.	Unit	PU	MRP	HS Code
	<b>AvanTech You: NL-450 mm Height-251 mm (70 Kg) Full Extn. Silent</b>							
	9255230	9255230	Drawer Side Profile (Anthracite), Left	1	Pc	1	3,740	94039010
	9255231	9255231	Drawer Side Profile (Anthracite), Right	1	Pc	1	3,740	94039010
	9255826	9255826	Design Profile (Anthracite)	2	Pc	2	276	39169090
	9255838	9255838	front Panel Connector for drawer side profile	2	Pc	2	1,496	83024200
	9257696	9257696	Rear Panel Connector (Anthracite), Left	1	Pc	1	667	83024200
	9257697	9257697	Rear Panel Connector (Anthracite), Right	1	Pc	1	667	83024200
	9257702	9257702	Rear Panel Stabilizer	3	Pc	3	39	39263000
	9123080	9123080	Front Stabilizer	1	Pc	1	438	39263000
	9257013	9257013	Actro You runner Left, 70 kg	1	Pc	1	2,291	83024200
	9257014	9257014	Actro You runner Right, 70 kg	1	Pc	1	2,291	83024200
	9257705	9257705	Branding clip with Hettich Logo Anthracite	1	Pc	1	40	39269097
	9257887	9257887	Drawer front connector side profile, stabiliser	2	Pc	2	140	39269097
BOM Code	9307381						15,825	
	<b>AvanTech You: NL-500 mm Height-251 mm (70 Kg) Full Extn. Silent</b>							
	9255232	9255232	Drawer Side Profile (Anthracite), Left	1	Pc	1	3,797	94039010
	9255233	9255233	Drawer Side Profile (Anthracite), Right	1	Pc	1	3,797	94039010
	9255827	9255827	Design Profile (Anthracite)	2	Pc	2	276	39169090
	9255838	9255838	front Panel Connector for drawer side profile	2	Pc	2	1,496	83024200
	9257696	9257696	Rear Panel Connector (Anthracite), Left	1	Pc	1	667	83024200
	9257697	9257697	Rear Panel Connector (Anthracite), Right	1	Pc	1	667	83024200
	9257702	9257702	Rear Panel Stabilizer	3	Pc	3	39	39263000
	9123080	9123080	Front Stabilizer	1	Pc	1	438	39263000
	9257017	9257017	Actro You runner Left, 70 kg	1	Pc	1	2,319	83024200
	9257018	9257018	Actro You runner Right, 70 kg	1	Pc	1	2,319	83024200
	9257705	9257705	Branding clip with Hettich Logo Anthracite	1	Pc	1	40	39269097
	9257887	9257887	Drawer front connector side profile, stabiliser	2	Pc	2	140	39269097
BOM-Code	9298401						15,995	
	<b>AvanTech You: NL-550 mm Height-251 mm (70 Kg) Full Extn. Silent</b>							
	9255234	9255234	Drawer Side Profile (Anthracite), Left	1	Pc	1	3,865	94039010
	9255235	9255235	Drawer Side Profile (Anthracite), Right	1	Pc	1	3,865	94039010
	9255828	9255828	Design Profile (Anthracite)	2	Pc	2	276	39169090
	9255838	9255838	front Panel Connector for drawer side profile	2	Pc	2	1,496	83024200
	9257696	9257696	Rear Panel Connector (Anthracite), Left	1	Pc	1	667	83024200
	9257697	9257697	Rear Panel Connector (Anthracite), Right	1	Pc	1	667	83024200
	9257702	9257702	Rear Panel Stabilizer	3	Pc	3	39	39263000
	9123080	9123080	Front Stabilizer	1	Pc	1	438	39263000
	9257021	9257021	Actro You runner Left, 70 kg	1	Pc	1	2,438	83024200
	9257022	9257022	Actro You runner Right, 70 kg	1	Pc	1	2,438	83024200
	9257705	9257705	Branding clip with Hettich Logo Anthracite	1	Pc	1	40	39269097
	9257887	9257887	Drawer front connector side profile, stabiliser	2	Pc	2	140	39269097
BOM-Code	9307401						16,369	





# Drawer System: AvanTech YOU

- ▶ Drawer height 187 mm, Inlay Drawer
- ▶ Anthracite



Product	Article No.	SAP	Item Description	Qty.	Unit	PU	MRP	HS Code
	<b>AvanTech YOU Inlay - 400 mm (40 Kg) Full Extn. Silent</b>							
	9257161	9257161	Inlay Drawer Side Profile, Left	1	Pc	1	2,290	94039910
	9257162	9257162	Inlay Drawer Side Profile, Right	1	Pc	1	2,290	94039910
	9257257	9257257	Drawer front connector for Inlay drawer side profile	2	Pc	2	836	83024200
	9268677	9268677	Adapter for Inlay drawer side profile	4	Pc	4	728	39169090
	9257694	9257694	Rear Panel Connector (Anthracite), Left	1	Pc	1	450	83024200
	9257695	9257695	Rear Panel Connector (Anthracite), Right	1	Pc	1	450	83024200
	9257702	9257702	Rear Panel Stabilizer	3	Pc	3	39	39263090
	9123080	9123080	Front Stabilizer	1	Pc	1	438	39263090
	9318175	9318175	Actro You Drawer runner-40kg, Left	1	Pc	1	1,715	83024200
	9318176	9318176	Actro You Drawer runner-40kg, Right	1	Pc	1	1,715	83024200
	9257705	9257705	Branding clip with Hettich Logo (Anthracite)	1	Pc	1	40	39269099
	BOM Code	9323711						10,991

	<b>AvanTech You Inlay - 450 mm (40 Kg) Full Extn. Silent</b>							
	9257163	9257163	Inlay Drawer Side Profile, Left	1	Pc	1	2,420	94039910
	9257164	9257164	Inlay Drawer Side Profile, Right	1	Pc	1	2,420	94039910
	9257257	9257257	Drawer front connector for Inlay drawer side profile	2	Pc	2	836	83024200
	9268677	9268677	Adapter for Inlay drawer side profile	4	Pc	4	728	39169090
	9257694	9257694	Rear Panel Connector (Anthracite), Left	1	Pc	1	450	83024200
	9257695	9257695	Rear Panel Connector (Anthracite), Right	1	Pc	1	450	83024200
	9257702	9257702	Rear Panel Stabilizer	3	Pc	3	39	39263090
	9123080	9123080	Front Stabilizer	1	Pc	1	438	39263090
	9318177	9318177	Actro You Drawer runner-40kg, Left	1	Pc	1	1,750	83024200
	9318178	9318178	Actro You Drawer runner-40kg, Right	1	Pc	1	1,750	83024200
	9257705	9257705	Branding clip with Hettich Logo (Anthracite)	1	Pc	1	40	39269099
	BOM Code	9323714						11,321





	<b>AvanTech You Inlay - 500 mm (40 Kg) Full Extn. Silent</b>							
	9257165	9257165	Inlay Drawer Side Profile, Left	1	Pc	1	2,470	94039910
	9257166	9257166	Inlay Drawer Side Profile, Right	1	Pc	1	2,470	94039910
	9257257	9257257	Drawer front connector for Inlay drawer side profile	2	Pc	2	836	83024200
	9268677	9268677	Adapter for Inlay drawer side profile	4	Pc	4	728	39169090
	9257694	9257694	Rear Panel Connector (Anthracite), Left	1	Pc	1	450	83024200
	9257695	9257695	Rear Panel Connector (Anthracite), Right	1	Pc	1	450	83024200
	9257702	9257702	Rear Panel Stabilizer	3	Pc	3	39	39263090
	9123080	9123080	Front Stabilizer	1	Pc	1	438	39263090
	9318179	9318179	Actro You Drawer runner-40kg, Left	1	Pc	1	1,771	83024200
	9318180	9318180	Actro You Drawer runner-40kg, Right	1	Pc	1	1,771	83024200
	9257705	9257705	Branding clip with Hettich Logo Anthracite	1	Pc	1	40	39269099
	BOM Code	9323720						11,463

	<b>AvanTech You Inlay - 550 mm (40 Kg) Full Extn. Silent</b>							
	9257167	9257167	Inlay Drawer Side Profile, Left	1	Pc	1	2,510	94039910
	9257168	9257168	Inlay Drawer Side Profile, Right	1	Pc	1	2,510	94039910
	9257257	9257257	Drawer front connector for Inlay drawer side profile	2	Pc	2	836	83024200
	9268677	9268677	Adapter for Inlay drawer side profile	4	Pc	4	728	39169090
	9257694	9257694	Rear Panel Connector (Anthracite), Left	1	Pc	1	450	83024200
	9257695	9257695	Rear Panel Connector (Anthracite), Right	1	Pc	1	450	83024200
	9257702	9257702	Rear Panel Stabilizer	3	Pc	3	39	39263090
	9123080	9123080	Front Stabilizer	1	Pc	1	438	39263090
	9318181	9318181	Actro You Drawer runner-40kg, Left	1	Pc	1	1,886	83024200
	9318182	9318182	Actro You Drawer runner-40kg, Right	1	Pc	1	1,886	83024200
	9257705	9257705	Branding clip with Hettich Logo Anthracite	1	Pc	1	40	39269099
	BOM Code	9323726						11,773

## Drawer System: AvanTech YOU

- ▶ Drawer height 187 mm, Inlay Drawer & Narrow Pullout
- ▶ Anthracite



Product	Article No.	SAP	Item Description	Qty.	Unit	PU	MRP	HS Code
	<b>AvanTech YOU Inlay - 450 mm (70 Kg) Full Extn. Silent</b>							
	9257163	9257163	Inlay Drawer Side Profile, Left	1	Pc	1	2,420	94039910
	9257164	9257164	Inlay Drawer Side Profile, Right	1	Pc	1	2,420	94039910
	9257257	9257257	Drawer front connector for Inlay drawer side profile	2	Pc	2	836	83024200
	9268677	9268677	Adapter for Inlay drawer side profile	4	Pc	4	728	39169090
	9257694	9257694	Rear Panel Connector (Anthracite), Left	1	Pc	1	450	83024200
	9257695	9257695	Rear Panel Connector (Anthracite), Right	1	Pc	1	450	83024200
	9257702	9257702	Rear Panel Stabilizer	3	Pc	3	39	39263090
	9123080	9123080	Front Stabilizer	1	Pc	1	438	39263090
	9257013	9257013	Actro You Drawer runner-70kg, Left	1	Pc	1	2,291	83024200
	9257014	9257014	Actro You Drawer runner-70kg, Right	1	Pc	1	2,291	83024200
	9257705	9257705	Branding clip with Hettich Logo Anthracite	1	Pc	1	40	39269099
	BOM Code	9323717						12,403
	<b>AvanTech YOU Inlay - 500 mm (70 Kg) Full Extn. Silent</b>							
	9257165	9257165	Inlay Drawer Side Profile, Left	1	Pc	1	2,470	94039910
	9257166	9257166	Inlay Drawer Side Profile, Right	1	Pc	1	2,470	94039910
	9257257	9257257	Drawer front connector for Inlay drawer side profile	2	Pc	2	836	83024200
	9268677	9268677	Adapter for Inlay drawer side profile	4	Pc	4	728	39169090
	9257694	9257694	Rear Panel Connector (Anthracite), Left	1	Pc	1	450	83024200
	9257695	9257695	Rear Panel Connector (Anthracite), Right	1	Pc	1	450	83024200
	9257702	9257702	Rear Panel Stabilizer	3	Pc	3	39	39263090
	9123080	9123080	Front Stabilizer	1	Pc	1	438	39263090
	9257017	9257017	Actro You Drawer runner-70kg, Left	1	Pc	1	2,319	83024200
	9257018	9257018	Actro You Drawer runner-70kg, Right	1	Pc	1	2,319	83024200
	9257705	9257705	Branding clip with Hettich Logo Anthracite	1	Pc	1	40	39269099
	BOM Code	9323723						12,559
	<b>AvanTech YOU Inlay - 550 mm (70 Kg) Full Extn. Silent</b>							
	9257167	9257167	Inlay Drawer Side Profile, Left	1	Pc	1	2,510	94039910
	9257168	9257168	Inlay Drawer Side Profile, Right	1	Pc	1	2,510	94039910
	9257257	9257257	Drawer front connector for Inlay drawer side profile	2	Pc	2	836	83024200
	9268677	9268677	Adapter for Inlay drawer side profile	4	Pc	4	728	39169090
	9257694	9257694	Rear Panel Connector (Anthracite), Left	1	Pc	1	450	83024200
	9257695	9257695	Rear Panel Connector (Anthracite), Right	1	Pc	1	450	83024200
	9257702	9257702	Rear Panel Stabilizer	3	Pc	3	39	39263090
	9123080	9123080	Front Stabilizer	1	Pc	1	438	39263090
	9257021	9257021	Actro You Drawer runner-70kg, Left	1	Pc	1	2,438	83024200
	9257022	9257022	Actro You Drawer runner-70kg, Right	1	Pc	1	2,438	83024200
	9257705	9257705	Branding clip with Hettich Logo Anthracite	1	Pc	1	40	39269099
	BOM Code	9323729						12,877
	<b>AvanTech You Narrow Pullout units NL 500 mm</b>							
	9332321	9332321	AvanTech You Narrow Pullout (Height 101+187 mm)/ Anthracite/ 20 Kg/ Depth 500 mm	1	Set	1	15,532	94039010
	9332328	9332328	AvanTech You- Narrow Pullout (Height 101+251 mm)/ Anthracite/ 20 Kg/ Depth 500 mm	1	Set	1	19,216	94039010

# Drawer System: AvanTech YOU

- ▶ LED Profile Light (Regular / Internal Drawer)
- ▶ Anthracite



Product	Article No.	SAP	Item Description	Qty.	Unit	PU	MRP	HS Code	
	<b>AvanTech You LED Profile Light - 400 mm (Regular Drawer)</b>								
	9336473	9336473	AVT YOU LED profile, NW, D 400 MM, Finish Anthracite	1	Set	1	5,050	94054231	
	9336477	9336477	AVT YOU Battery pack, wooden rear panel, USB rechargeable, 7.5 V DC, 3x cable clip	1	Pc	1	5,550	85044055	
	9336481	9336481	Magnet with chipboard screw	1	Pc	1	520	85051990	
	BOM Code	9350424					11,120		
	<b>AvanTech You LED Profile Light - 450 mm (Regular Drawer)</b>								
	9336474	9336474	AVT YOU LED profile, NW, D 450 MM, Finish Anthracite	1	Set	1	5,100	94054231	
	9336477	9336477	AVT YOU Battery pack, wooden rear panel, USB rechargeable, 7.5 V DC, 3x cable clip	1	Pc	1	5,550	85044055	
	9336481	9336481	Magnet with chipboard screw	1	Pc	1	520	85051990	
	BOM Code	9350425					11,170		
	<b>AvanTech YOU LED Profile Light - 500 mm (Regular Drawer)</b>								
	9336475	9336475	AVT YOU LED profile, NW, D 500 MM, Finish Anthracite	1	Set	1	5,150	94054231	
	9336477	9336477	AVT YOU Battery pack, wooden rear panel, USB rechargeable, 7.5 V DC, 3x cable clip	1	Pc	1	5,550	85044055	
	9336481	9336481	Magnet with chipboard screw	1	Pc	1	520	85051990	
	BOM Code	9350426					11,220		
	<b>AvanTech You LED Profile Light - 550 mm (Regular Drawer)</b>								
	9336476	9336476	AVT YOU LED profile, NW, D 550 MM, Finish Anthracite	1	Set	1	5,200	94054231	
	9336477	9336477	AVT YOU Battery pack, wooden rear panel, USB rechargeable, 7.5 V DC, 3x cable clip	1	Pc	1	5,550	85044055	
	9336481	9336481	Magnet with chipboard screw	1	Pc	1	520	85051990	
	BOM Code	9350427					11,270		
	<b>AvanTech You LED Profile Light - 400 mm (Internal Drawer)</b>								
	9336473	9336473	AVT YOU LED profile, NW, D 400 MM, Finish Anthracite	1	Set	1	5,050	94054231	
	9336477	9336477	AVT YOU Battery pack, wooden rear panel, USB rechargeable, 7.5 V DC, 3x cable clip	1	Pc	1	5,550	85044055	
	9336482	9336482	Magnet with 24mm distance for inside drawers with chipboard screw to press in	1	Pc	1	750	85051990	
	BOM Code	9350429					11,350		
	<b>AvanTech You LED Profile Light - 450 mm (Internal Drawer)</b>								
	9336474	9336474	AVT YOU LED profile, NW, D 450 MM, Finish Anthracite	1	Set	1	5,100	94054231	
	9336477	9336477	AVT YOU Battery pack, wooden rear panel, USB rechargeable, 7.5 V DC, 3x cable clip	1	Pc	1	5,550	85044055	
	9336482	9336482	Magnet with 24mm distance for inside drawers with chipboard screw to press in	1	Pc	1	750	85051990	
	BOM Code	9350430					11,400		

## Drawer System: AvanTech YOU

- ▶ LED Profile / Inlay Light (Regular / Internal Drawer)
- ▶ Anthracite



Product	Article No.	SAP	Item Description	Qty.	Unit	PU	MRP	HS Code
<b>AvanTech You LED Profile Light – 500 mm (Internal Drawer)</b>								
	9336475	9336475	AVT YOU LED profile, NW, D 500 MM, Finish Anthracite	1	Set	1	5,150	94054231
	9336477	9336477	AVT YOU Battery pack, wooden rear panel, USB rechargeable, 7.5 V DC, 3x cable clip	1	Pc	1	5,550	85044055
	9336482	9336482	Magnet with 24mm distance for inside drawers with chipboard screw to press in	1	Pc	1	750	85051990
	BOM Code	9350431					11,450	
<b>AvanTech You LED Profile Light – 550 mm (Internal Drawer)</b>								
	9336476	9336476	AVT YOU LED profile, NW, D 550 MM, Finish Anthracite	1	Set	1	5,200	94054231
	9336477	9336477	AVT YOU Battery pack, wooden rear panel, USB rechargeable, 7.5 V DC, 3x cable clip	1	Pc	1	5,550	85044055
	9336482	9336482	Magnet with 24mm distance for inside drawers with chipboard screw to press in	1	Pc	1	750	85051990
	BOM Code	9350432					11,500	
<b>AvanTech You LED Inlay Profile Light (Regular Drawer)</b>								
	9336478	9336478	AVT YOU Inlay LED Set	1	Set	1	4,550	94054231
	9336477	9336477	AVT YOU Battery pack, wooden rear panel, USB rechargeable, 7.5 V DC, 3x cable clip	1	Pc	1	5,550	85044055
	9336481	9336481	Magnet with chipboard screw	1	Pc	1	520	85051990
	BOM Code	9350428					10,620	
<b>AvanTech You LED Inlay Profile Light (Internal Drawer)</b>								
	9336478	9336478	AVT YOU Inlay LED Set	1	Set	1	4,550	94054231
	9336477	9336477	AVT YOU Battery pack, wooden rear panel, USB rechargeable, 7.5 V DC, 3x cable clip	1	Pc	1	5,550	85044055
	9336482	9336482	Magnet with 24mm distance for inside drawers with chipboard screw to press in	1	Pc	1	750	85051990
	BOM Code	9350433					10,850	







# Drawer System: AvanTech

- ▶ Drawer height 101 mm
- ▶ Silver



Product	Article No.	SAP	Item Description	Qty.	Unit	PU	MRP	HS Code
	<b>AvanTech – 400 mm (30 Kg) Full Extn. Silent</b>							
	9255014	9255014	Drawer side profile (Silver)-Left	1	Pc	1	1,342	94039010
	9255015	9255015	Drawer side profile (Silver)-Right	1	Pc	1	1,342	94039010
	9255807	9255807	Design profile (Silver)	2	Pc	2	292	39169090
	9255835	9255835	Front connector for drawer side profile	2	Pc	2	806	83024200
	9257666	9257666	Rear Panel Connector (Silver), Left	1	Pc	1	305	83024200
	9257667	9257667	Rear panel connector (Silver), Right	1	Pc	1	305	83024200
	9257702	9257702	Rear Panel stabilizer	3	Pc	3	39	39263000
	9123080	9123080	Front stabiliser	1	Pc	1	438	39263000
	9303772	9303772	Quadro You Drawer runner-30kg, Left	1	Pc	1	1,425	83024200
	9303773	9303773	Quadro You Drawer runner-30kg, Right	1	Pc	1	1,425	83024200
	9257703	9257703	Branding clip with Hettich Logo- Silver	1	Pc	1	40	39269097
	BOM Code	9343370					7,759	

	<b>AvanTech – 450 mm (30 Kg) Full Extn. Silent</b>							
	9255016	9255016	Drawer Side Profile (Silver), Left	1	Pc	1	1,485	94039010
	9255017	9255017	Drawer Side Profile (Silver), Right	1	Pc	1	1,485	94039010
	9255808	9255808	Design Profile (Silver)	2	Pc	2	276	39169090
	9255835	9255835	Front Panel Connector for drawer side profile	4	Pc	4	806	83024200
	9257666	9257666	Rear Panel Connector (Silver), Left	1	Pc	1	305	83024200
	9257667	9257667	Rear Panel Connector (Silver), Right	1	Pc	1	305	83024200
	9257702	9257702	Rear Panel Stabilizer	3	Pc	3	39	39263000
	9123080	9123080	Front Stabilizer	1	Pc	1	438	39263000
	9303776	9303776	Quadro You Drawer runner-30kg, Left	1	Pc	1	1,485	83024200
	9303777	9303777	Quadro You Drawer runner-30kg, Right	1	Pc	1	1,485	83024200
	9257703	9257703	Branding clip with Hettich logo (silver)	1	Pc	1	40	39269097
	BOM Code	9343333					8,149	

	<b>AvanTech – 500 mm (30 Kg) Full Extn. Silent</b>							
	9255018	9255018	Drawer Side Profile (Silver), Left	1	Pc	1	1,518	94039910
	9255019	9255019	Drawer Side Profile (Silver), Right	1	Pc	1	1,518	94039910
	9255809	9255809	Design Profile (Silver)	2	Pc	2	276	83024200
	9255835	9255835	Front Panel Connector for drawer side profile	4	Pc	4	806	39169090
	9257666	9257666	Rear Panel Connector (Silver), Left	1	Pc	1	305	83024200
	9257667	9257667	Rear Panel Connector (Silver), Right	1	Pc	1	305	83024200
	9257702	9257702	Rear Panel Stabilizer	3	Pc	3	39	39263090
	9123080	9123080	Front Stabilizer	1	Pc	1	438	39263090
	9303780	9303780	Quadro You Drawer runner-30kg, Left	1	Pc	1	1,545	83024200
	9303781	9303781	Quadro You Drawer runner-30kg, Right	1	Pc	1	1,545	83024200
	9257703	9257703	Branding clip with Hettich logo (silver)	1	Pc	1	40	39269099
	BOM Code	9343352					8,335	

	<b>AvanTech – 550 mm (30 Kg) Full Extn. Silent</b>							
	9255020	9255020	Drawer Side Profile (Silver), Left	1	Pc	1	1,541	94039910
	9255021	9255021	Drawer Side Profile (Silver), Right	1	Pc	1	1,541	94039910
	9255810	9255810	Design Profile (Silver)	2	Pc	2	276	83024200
	9255835	9255835	Front Panel Connector for drawer side profile	4	Pc	4	806	39169090
	9257666	9257666	Rear Panel Connector (Silver), Left	1	Pc	1	305	83024200
	9257667	9257667	Rear Panel Connector (Silver), Right	1	Pc	1	305	83024200
	9257702	9257702	Rear Panel Stabilizer	3	Pc	3	39	39263090
	9123080	9123080	Front Stabilizer	1	Pc	1	438	39263090
	9303784	9303784	Quadro You Drawer runner-30kg, Left	1	Pc	1	1,665	83024200
	9303785	9303785	Quadro You Drawer runner-30kg, Right	1	Pc	1	1,665	83024200
	9257703	9257703	Branding clip with Hettich logo (silver)	1	Pc	1	40	39269099
	BOM Code	9343324					8,621	

# Drawer System: AvanTech

- ▶ Drawer height 187 mm
- ▶ Silver





Product	Article No.	SAP	Item Description	Qty.	Unit	PU	MRP	HS Code	
	<b>AvanTech – 400 mm (30 Kg) Full Extn. Silent</b>								
	9255050	9255050	Drawer Side Profile (Silver), Left	1	Pc	1	2,128	94039010	
	9255051	9255051	Drawer Side Profile (Silver), Right	1	Pc	1	2,128	94039010	
	9255807	9255807	Design Profile (Silver)	2	Pc	2	292	39169090	
	9255838	9255838	Front Panel Connector for drawer side profile	2	Pc	2	1,496	83024200	
	9257670	9257670	Rear Panel Connector (Silver), Left	1	Pc	1	450	83024200	
	9257671	9257671	Rear Panel Connector (Silver), Right	1	Pc	1	450	83024200	
	9257702	9257702	Rear Panel Stabilizer	3	Pc	3	39	39263000	
	9123080	9123080	Front Stabilizer	1	Pc	1	438	39263000	
	9303772	9303772	Quadro You Drawer runner-30kg, Left	1	Pc	1	1,425	83024200	
	9303773	9303773	Quadro You Drawer runner-30kg, Right	1	Pc	1	1,425	83024200	
	9257703	9257703	Branding clip with Hettich Logo Silver	1	Pc	1	40	39269097	
	BOM Code	9343371						10,311	
	<b>AvanTech – 450 mm (30 Kg) Full Extn. Silent</b>								
	9255052	9255052	Drawer Side Profile (Silver), Left	1	Pc	1	2,210	94039010	
	9255053	9255053	Drawer Side Profile (Silver), Right	1	Pc	1	2,210	94039010	
	9255808	9255808	Design Profile (Silver)	2	Pc	2	276	39169090	
	9255838	9255838	Front Panel Connector for drawer side profile	2	Pc	2	1,496	83024200	
	9257670	9257670	Rear Panel Connector (Silver), Left	1	Pc	1	450	83024200	
	9257671	9257671	Rear Panel Connector (Silver), Right	1	Pc	1	450	83024200	
	9257702	9257702	Rear Panel Stabilizer	3	Pc	3	39	39263000	
	9123080	9123080	Front Stabilizer	1	Pc	1	438	39263000	
	9303776	9303776	Quadro You Drawer runner-30kg, Left	1	Pc	1	1,485	83024200	
	9303777	9303777	Quadro You Drawer runner-30kg, Right	1	Pc	1	1,485	83024200	
	9257703	9257703	Branding clip with Hettich logo (silver)	1	Pc	1	40	39269097	
	BOM Code	9343334						10,579	
	<b>AvanTech – 500 mm (30 Kg) Full Extn. Silent</b>								
	9255054	9255054	Drawer Side Profile (Silver), Left	1	Pc	1	2,242	94039010	
	9255055	9255055	Drawer Side Profile (Silver), Right	1	Pc	1	2,242	94039010	
	9255809	9255809	Design Profile (Silver)	2	Pc	2	276	39169090	
	9255838	9255838	Front Panel Connector for drawer side profile	2	Pc	2	1,496	83024200	
	9257670	9257670	Rear Panel Connector (Silver), Left	1	Pc	1	450	83024200	
	9257671	9257671	Rear Panel Connector (Silver), Right	1	Pc	1	450	83024200	
	9257702	9257702	Rear Panel Stabilizer	3	Pc	3	39	39263000	
	9123080	9123080	Front Stabilizer	1	Pc	1	438	39263000	
	9303780	9303780	Quadro You Drawer runner-30kg, Left	1	Pc	1	1,545	83024200	
	9303781	9303781	Quadro You Drawer runner-30kg, Right	1	Pc	1	1,545	83024200	
	9257703	9257703	Branding clip with Hettich logo (silver)	1	Pc	1	40	39269097	
	BOM Code	9343353						10,763	
	<b>AvanTech – 550 mm (30 Kg) Full Extn. Silent</b>								
	9255056	9255056	Drawer Side Profile (Silver), Left	1	Pc	1	2,289	94039010	
	9255057	9255057	Drawer Side Profile (Silver), Right	1	Pc	1	2,289	94039010	
	9255810	9255810	Design Profile (Silver)	2	Pc	2	276	39169090	
	9255838	9255838	Front Panel Connector for drawer side profile	2	Pc	2	1,496	83024200	
	9257670	9257670	Rear Panel Connector (Silver), Left	1	Pc	1	450	83024200	
	9257671	9257671	Rear Panel Connector (Silver), Right	1	Pc	1	450	83024200	
	9257702	9257702	Rear Panel Stabilizer	3	Pc	3	39	39263000	
	9123080	9123080	Front Stabilizer	1	Pc	1	438	39263000	
	9303784	9303784	Quadro You Drawer runner-30kg, Left	1	Pc	1	1,665	83024200	
	9303785	9303785	Quadro You Drawer runner-30kg, Right	1	Pc	1	1,665	83024200	
	9257703	9257703	Branding clip with Hettich logo (silver)	1	Pc	1	40	39269097	
	BOM Code	9343325						11,097	

# Drawer System: AvanTech

- ▶ Drawer height 251 mm
- ▶ Silver



Product	Article No.	SAP	Item Description	Qty.	Unit	PU	MRP	HS Code	
	<b>AvanTech – 400 mm (30 Kg) Full Extn. Silent</b>								
	9255068	9255068	Drawer Side Profile (Silver), Left	1	Pc	1	3,876	94039010	
	9255069	9255069	Drawer Side Profile (Silver), Right	1	Pc	1	3,876	94039010	
	9255807	9255807	Design Profile (Silver)	2	Pc	2	292	39169090	
	9255838	9255838	Front Panel Connector for drawer side profile	2	Pc	2	1,496	83024200	
	9257672	9257672	Rear Panel Connector (Silver), Left	1	Pc	1	667	83024200	
	9257673	9257673	Rear Panel Connector (Silver), Right	1	Pc	1	667	83024200	
	9257702	9257702	Rear Panel Stabilizer	3	Pc	3	39	39263000	
	9123080	9123080	Front Stabilizer	1	Pc	1	438	39263000	
	9303772	9303772	Quadro You Drawer runner-30kg, Left	1	Pc	1	1,425	83024200	
	9303773	9303773	Quadro You Drawer runner-30kg, Right	1	Pc	1	1,425	83024200	
	9257703	9257703	Branding clip with Hettich logo (Silver)	1	Pc	1	40	39269097	
	9257887	9257887	Drawer front connector side profile, stabiliser	2	Pc	2	140	39269097	
	BOM Code	9343372						14,381	
		<b>AvanTech – 450 mm (30 Kg) Full Extn. Silent</b>							
9255070		9255070	Drawer Side Profile (Silver), Left	1	Pc	1	3,740	94039010	
9255071		9255071	Drawer Side Profile (Silver), Right	1	Pc	1	3,740	94039010	
9255808		9255808	Design Profile (Silver)	2	Pc	2	276	39169090	
9255838		9255838	Front Panel Connector for drawer side profile	2	Pc	2	1,496	83024200	
9257672		9257672	Rear Panel Connector (Silver), Left	1	Pc	1	667	83024200	
9257673		9257673	Rear Panel Connector (Silver), Right	1	Pc	1	667	83024200	
9257702		9257702	Rear Panel Stabilizer	3	Pc	3	39	39263000	
9123080		9123080	Front Stabilizer	1	Pc	1	438	39263000	
9303776		9303776	Quadro You Drawer runner-30kg, Left	1	Pc	1	1,485	83024200	
9303777		9303777	Quadro You Drawer runner-30kg, Right	1	Pc	1	1,485	83024200	
9257887		9257887	Drawer front connector side profile, stabiliser	1	Pc	1	140	39269097	
9257703		9257703	Branding clip with Hettich logo (silver)	2	Pc	2	40	39269097	
BOM Code		9343335						14,213	
		<b>AvanTech – 500 mm (30 Kg) Full Extn. Silent</b>							
	9255072	9255072	Drawer Side Profile (Silver), Left	1	Pc	1	3,797	94039010	
	9255073	9255073	Drawer Side Profile (Silver), Right	1	Pc	1	3,797	94039010	
	9255809	9255809	Design Profile (Silver)	2	Pc	2	276	39169090	
	9255838	9255838	Front Panel Connector for drawer side profile	2	Pc	2	1,496	83024200	
	9257672	9257672	Rear Panel Connector (Silver), Left	1	Pc	1	667	83024200	
	9257673	9257673	Rear Panel Connector (Silver), Right	1	Pc	1	667	83024200	
	9257702	9257702	Rear Panel Stabilizer	3	Pc	3	39	39263000	
	9123080	9123080	Front Stabilizer	1	Pc	1	438	39263000	
	9303780	9303780	Quadro You Drawer runner-30kg, Left	1	Pc	1	1,545	83024200	
	9303781	9303781	Quadro You Drawer runner-30kg, Right	1	Pc	1	1,545	83024200	
	9257703	9257703	Branding clip with Hettich logo (silver)	1	Pc	1	40	39269097	
	9257887	9257887	Drawer front connector side profile, stabiliser	2	Pc	2	140	39269097	
	BOM Code	9343354						14,447	

## Drawer System: AvanTech

- ▶ Drawer height 251 mm
- ▶ Silver



Product	Article No.	SAP	Item Description	Qty.	Unit	PU	MRP	HS Code	
	<b>AvanTech - 550 mm (30 Kg) Full Extn. Silent</b>								
	9255074	9255074	Drawer Side Profile (Silver), Left	1	Pc	1	3,865	94039010	
	9255075	9255075	Drawer Side Profile (Silver), Right	1	Pc	1	3,865	94039010	
	9255810	9255810	Design Profile (Silver)	2	Pc	2	276	39169090	
	9255838	9255838	Front Panel Connector for drawer side profile	2	Pc	2	1,496	83024200	
	9257672	9257672	Rear Panel Connector (Silver), Left	1	Pc	1	667	83024200	
	9257673	9257673	Rear Panel Connector (Silver), Right	1	Pc	1	667	83024200	
	9257702	9257702	Rear Panel Stabilizer	3	Pc	3	39	39263000	
	9123080	9123080	Front Stabilizer	1	Pc	1	438	39263000	
	9303784	9303784	Quadro You Drawer runner-30kg, Left	1	Pc	1	1,665	83024200	
	9303785	9303785	Quadro You Drawer runner-30kg, Right	1	Pc	1	1,665	83024200	
	9257703	9257703	Branding clip with Hettich logo (silver)	1	Pc	1	40	39269097	
	9257887	9257887	Drawer front connector side profile, stabiliser	2	Pc	2	140	39269097	
	BOM Code	9343326						14,823	



# Drawer System: AvanTech

- ▶ Drawer height 187 mm
- ▶ Silver





Product	Article No.	SAP	Item Description	Qty.	Unit	PU	MRP	HS Code
	<b>AvanTech Inlay - 400 mm (30 Kg) Full Extn. Silent</b>							
	9257133	9257133	Inlay Drawer Side Profile, Left	1	Pc	1	2,290	94039910
	9257134	9257134	Inlay Drawer Side Profile, Right	1	Pc	1	2,290	94039910
	9257257	9257257	Drawer front connector for inlay drawer side profile	2	Pc	2	836	83024200
	9268677	9268677	Adapter for Inlay drawer side profile	4	Pc	4	728	39169090
	9257670	9257670	Rear Panel Connector (Silver), Left	1	Pc	1	450	83024200
	9257671	9257671	Rear Panel Connector (Silver), Right	1	Pc	1	450	83024200
	9257702	9257702	Rear Panel Stabilizer	3	Pc	3	39	39263090
	9123080	9123080	Front Stabilizer	1	Pc	1	438	39263090
	9303772	9303772	Quadro You Drawer runner-30kg, Left	1	Pc	1	1,425	83024200
	9303773	9303773	Quadro You Drawer runner-30kg, Right	1	Pc	1	1,425	83024200
	9257703	9257703	Branding clip with Hettich logo (silver)	1	Pc	1	40	39269099
	BOM Code	9343321						10,411
	<b>AvanTech Inlay - 450 mm (30 Kg) Full Extn. Silent</b>							
	9257135	9257135	Inlay Drawer Side Profile, Left	1	Pc	1	2,420	94039910
	9257136	9257136	Inlay Drawer Side Profile, Right	1	Pc	1	2,420	94039910
	9257257	9257257	Drawer front connector for inlay drawer side profile	2	Pc	2	836	83024200
	9268677	9268677	Adapter for Inlay drawer side profile	4	Pc	4	728	39169090
	9257670	9257670	Rear Panel Connector (Silver), Left	1	Pc	1	450	83024200
	9257671	9257671	Rear Panel Connector (Silver), Right	1	Pc	1	450	83024200
	9257702	9257702	Rear Panel Stabilizer	3	Pc	3	39	39263090
	9123080	9123080	Front Stabilizer	1	Pc	1	438	39263090
	9303776	9303776	Quadro You Drawer runner-30kg, Left	1	Pc	1	1,485	83024200
	9303777	9303777	Quadro You Drawer runner-30kg, Right	1	Pc	1	1,485	83024200
	9257703	9257703	Branding clip with Hettich logo (silver)	1	Pc	1	40	39269099
	BOM Code	9343266						10,791
	<b>AvanTech Inlay - 500 mm (30 Kg) Full Extn. Silent</b>							
	9257137	9257137	Inlay Drawer Side Profile, Left	1	Pc	1	2,470	94039910
	9257138	9257138	Inlay Drawer Side Profile, Right	1	Pc	1	2,470	94039910
	9257257	9257257	Drawer front connector for inlay drawer side profile	2	Pc	2	836	83024200
	9268677	9268677	Adapter for Inlay drawer side profile	4	Pc	4	728	39169090
	9257670	9257670	Rear Panel Connector (Silver), Left	1	Pc	1	450	83024200
	9257671	9257671	Rear Panel Connector (Silver), Right	1	Pc	1	450	83024200
	9257702	9257702	Rear Panel Stabilizer	3	Pc	3	39	39263090
	9123080	9123080	Front Stabilizer	1	Pc	1	438	39263090
	9303780	9303780	Quadro You Drawer runner-30kg, Left	1	Pc	1	1,545	83024200
	9303781	9303781	Quadro You Drawer runner-30kg, Right	1	Pc	1	1,545	83024200
	9257703	9257703	Branding clip with Hettich logo (silver)	1	Pc	1	40	39269099
	BOM Code	9343269						11,011
	<b>AvanTech Inlay - 550 mm (30 Kg) Full Extn. Silent</b>							
	9257139	9257139	Inlay Drawer Side Profile, Left	1	Pc	1	2,510	94039910
	9257140	9257140	Inlay Drawer Side Profile, Right	1	Pc	1	2,510	94039910
	9257257	9257257	Drawer front connector for inlay drawer side profile	2	Pc	2	836	83024200
	9268677	9268677	Adapter for Inlay drawer side profile	4	Pc	4	728	39169090
	9257670	9257670	Rear Panel Connector (Silver), Left	1	Pc	1	450	83024200
	9257671	9257671	Rear Panel Connector (Silver), Right	1	Pc	1	450	83024200
	9257702	9257702	Rear Panel Stabilizer	3	Pc	3	39	39263090
	9123080	9123080	Front Stabilizer	1	Pc	1	438	39263090
	9303784	9303784	Quadro You Drawer runner-30kg, Left	1	Pc	1	1,665	83024200
	9303785	9303785	Quadro You Drawer runner-30kg, Right	1	Pc	1	1,665	83024200
	9257703	9257703	Branding clip with Hettich logo (silver)	1	Pc	1	40	39269099
	BOM Code	9343312						11,331

# Drawer System: AvanTech

► White



Product	Article No.	SAP	Item Description	Qty.	Unit	PU	MRP	HS Code
<b>Drawer height 101 mm</b>								
	<b>AvanTech - 500 mm (30 Kg) Full Extn. Silent</b>							
	9255098	9255098	Drawer Side Profile (White), Left	1	Pc	1	1,518	94039910
	9255099	9255099	Drawer Side Profile (White), Right	1	Pc	1	1,518	94039910
	9255818	9255818	Design Profile (White)	2	Pc	2	276	83024200
	9255835	9255835	Front Panel Connector for drawer side profile	4	Pc	4	806	39169090
	9257678	9257678	Rear Panel Connector (White), Left	1	Pc	1	305	83024200
	9257679	9257679	Rear Panel Connector (White), Right	1	Pc	1	305	83024200
	9257702	9257702	Rear Panel Stabilizer	3	Pc	3	39	39263090
	9123080	9123080	Front Stabilizer	1	Pc	1	438	39263090
	9303780	9303780	Quadro You Drawer runner-30kg, Left	1	Pc	1	1,545	83024200
	9303781	9303781	Quadro You Drawer runner-30kg, Right	1	Pc	1	1,545	83024200
	9257704	9257704	Branding clip with Hettich logo (White)	1	Pc	1	40	39269099
	BOM Code	9343358						8,335
<b>Drawer height 187 mm</b>								
	<b>AvanTech - 500 mm (30 Kg) Full Extn. Silent</b>							
	9255134	9255134	Drawer Side Profile (White), Left	1	Pc	1	2,242	94039910
	9255135	9255135	Drawer Side Profile (White), Right	1	Pc	1	2,242	94039910
	9255818	9255818	Design Profile (White)	2	Pc	2	276	83024200
	9255838	9255838	Font Panel Connector for drawer side profile	4	Pc	4	1,496	39169090
	9257682	9257682	Rear Panel Connector (White), Left	1	Pc	1	450	83024200
	9257683	9257683	Rear Panel Connector (White), Right	1	Pc	1	450	83024200
	9257702	9257702	Rear Panel Stabilizer	3	Pc	3	39	39263090
	9123080	9123080	Front Stabilizer	1	Pc	1	438	39263090
	9303780	9303780	Quadro You Drawer runner-30kg, Left	1	Pc	1	1,545	83024200
	9303781	9303781	Quadro You Drawer runner-30kg, Right	1	Pc	1	1,545	83024200
	9257704	9257704	Branding clip with Hettich logo (White)	1	Pc	1	40	39269099
	BOM Code	9343359						10,763
<b>Drawer height 251 mm</b>								
	<b>AvanTech - 500 mm (30 Kg) Full Extn. Silent</b>							
	9255152	9255152	Drawer Side Profile (White), Left	1	Pc	1	3,797	94039010
	9255153	9255153	Drawer Side Profile (White), Right	1	Pc	1	3,797	94039010
	9255818	9255818	Design Profile (White)	2	Pc	2	276	39169090
	9255838	9255838	Font Panel Connector for drawer side profile	2	Pc	2	1,496	83024200
	9257684	9257684	Rear Panel Connector (White), Left	1	Pc	1	667	83024200
	9257685	9257685	Rear Panel Connector (White), Right	1	Pc	1	667	83024200
	9257702	9257702	Rear Panel Stabilizer	3	Pc	3	39	39263000
	9123080	9123080	Front Stabilizer	1	Pc	1	438	39263000
	9303780	9303780	Quadro You Drawer runner-30kg, Left	1	Pc	1	1,545	83024200
	9303781	9303781	Quadro You Drawer runner-30kg, Right	1	Pc	1	1,545	83024200
	9257704	9257704	Branding clip with Hettich logo white	1	Pc	1	40	39269097
	9257887	9257887	Drawer front connector side profile, stabiliser	2	Pc	2	140	39269097
BOM Code	9343360						14,447	

# Drawer System: AvanTech

- ▶ Inlay Drawer
- ▶ White



Product	Article No.	SAP	Item Description	Qty.	Unit	PU	MRP	HS Code
<b>Drawer height 187 mm</b>								
	<b>AvanTech Inlay - 500 mm (30 Kg) Full Extn. Silent</b>							
	9257151	9257151	Inlay Drawer Side Profile, Left	1	Pc	1	2,470	94039910
	9257152	9257152	Inlay Drawer Side Profile, Right	1	Pc	1	2,470	94039910
	9257257	9257257	Drawer front connector for inlay drawer side profile	2	Pc	2	836	83024200
	9268677	9268677	Adapter for Inlay drawer side profile	4	Pc	4	728	39169090
	9257682	9257682	Rear Panel Connector (White), Left	1	Pc	1	450	83024200
	9257683	9257683	Rear Panel Connector (White), Right	1	Pc	1	450	83024200
	9257702	9257702	Rear Panel Stabilizer	3	Pc	3	39	39263090
	9123080	9123080	Front Stabilizer	1	Pc	1	438	39263090
	9303780	9303780	Quadro You Drawer runner-30kg, Left	1	Pc	1	1,545	83024200
	9303781	9303781	Quadro You Drawer runner-30kg, Right	1	Pc	1	1,545	83024200
	9257704	9257704	Branding clip with Hettich Logo White	1	Pc	1	40	39269099
BOM Code	9343311						11,011	

# Drawer System: AvanTech

- ▶ Drawer height 101 mm
- ▶ Anthracite



Product	Article No.	SAP	Item Description	Qty.	Unit	PU	MRP	HS Code
<b>Drawer height 101 mm</b>								
	<b>AvanTech – 400 mm (30 Kg) Full Extn. Silent</b>							
	9255174	9255174	Drawer Side Profile (Anthracite), Left	1	Pc	1	1,342	94039910
	9255175	9255175	Drawer Side Profile (Anthracite), Right	1	Pc	1	1,342	94039910
	9255825	9255825	Design Profile (Anthracite)	2	Pc	2	292	83024200
	9255835	9255835	Front Panel Connector for drawer side profile	4	Pc	4	806	39169090
	9257690	9257690	Rear Panel Connector (Anthracite), Left	1	Pc	1	305	83024200
	9257691	9257691	Rear Panel Connector (Anthracite), Right	1	Pc	1	305	83024200
	9257702	9257702	Rear Panel Stabilizer	3	Pc	3	39	39263090
	9123080	9123080	Front Stabilizer	1	Pc	1	438	39263090
	9303772	9303772	Quadro You Drawer runner-30kg, Left	1	Pc	1	1,425	83024200
	9303773	9303773	Quadro You Drawer runner-30kg, Right	1	Pc	1	1,425	83024200
	9257705	9257705	Branding clip with Hettich Logo Anthracite	1	Pc	1	40	39269099
BOM Code	9343373						7,759	
	<b>AvanTech – 450 mm (30 Kg) Full Extn. Silent</b>							
	9255176	9255176	Inlay Drawer Side Profile, Left	1	Pc	1	1,485	94039910
	9255177	9255177	Inlay Drawer Side Profile, Right	1	Pc	1	1,485	94039910
	9255826	9255826	Drawer front connector for inlay drawer side profile	2	Pc	2	276	83024200
	9255835	9255835	Adapter for Inlay drawer side profile	4	Pc	4	806	39169090
	9257690	9257690	Rear Panel Connector (White), Left	1	Pc	1	305	83024200
	9257691	9257691	Rear Panel Connector (White), Right	1	Pc	1	305	83024200
	9257702	9257702	Rear Panel Stabilizer	3	Pc	3	39	39263090
	9123080	9123080	Front Stabilizer	1	Pc	1	438	39263090
	9303776	9303776	Quadro You Drawer runner-30kg, Left	1	Pc	1	1,485	83024200
	9303777	9303777	Quadro You Drawer runner-30kg, Right	1	Pc	1	1,485	83024200
	9257705	9257705	Branding clip with Hettich Logo White	1	Pc	1	40	39269099
BOM Code	9343336						8,149	
	<b>AvanTech – 500 mm (30 Kg) Full Extn. Silent</b>							
	9255176	9255176	Drawer Side Profile (Anthracite), Left	1	Pc	1	1,518	94039910
	9255177	9255177	Drawer Side Profile (Anthracite), Right	1	Pc	1	1,518	94039910
	9255826	9255826	Design Profile (Anthracite)	2	Pc	2	276	83024200
	9255835	9255835	Front Panel Connector for drawer side profile	4	Pc	4	806	39169090
	9257690	9257690	Rear Panel Connector Anthracite), Left	1	Pc	1	305	83024200
	9257691	9257691	Rear Panel Connector (Anthracite), Right	1	Pc	1	305	83024200
	9257702	9257702	Rear Panel Stabilizer	3	Pc	3	39	39263090
	9123080	9123080	Front Stabilizer	1	Pc	1	438	39263090
	9303776	9303776	Quadro You Drawer runner-30kg, Left	1	Pc	1	1,545	83024200
	9303777	9303777	Quadro You Drawer runner-30kg, Right	1	Pc	1	1,545	83024200
	9257705	9257705	Branding clip with Hettich Logo Anthracite	1	Pc	1	40	39269099
BOM Code	9343355						8,335	
	<b>AvanTech – 550 mm (30 Kg) Full Extn. Silent</b>							
	9255180	9255180	Drawer Side Profile (Anthracite), Left	1	Pc	1	1,541	94039910
	9255181	9255181	Drawer Side Profile (Anthracite), Right	1	Pc	1	1,541	94039910
	9255828	9255828	Design Profile (Anthracite)	2	Pc	2	276	83024200
	9255835	9255835	Front Panel Connector for drawer side profile	4	Pc	4	806	39169090
	9257690	9257690	Rear Panel Connector (Anthracite), Left	1	Pc	1	305	83024200
	9257691	9257691	Rear Panel Connector (Anthracite), Right	1	Pc	1	305	83024200
	9257702	9257702	Rear Panel Stabilizer	3	Pc	3	39	39263090
	9123080	9123080	Front Stabilizer	1	Pc	1	438	39263090
	9303784	9303784	Quadro You Drawer runner-30kg, Left	1	Pc	1	1,665	83024200
	9303785	9303785	Quadro You Drawer runner-30kg, Right	1	Pc	1	1,665	83024200
	9257705	9257705	Branding clip with Hettich logo (Anthracite)	1	Pc	1	40	39269099
BOM Code	9343327						8,621	



# Drawer System: AvanTech

- ▶ Drawer height 187 mm
- ▶ Anthracite



Product	Article No.	SAP	Item Description	Qty.	Unit	PU	MRP	HS Code
	<b>AvanTech – 400 mm (30 Kg) Full Extn. Silent</b>							
	9255210	9255210	Drawer Side Profile (Anthracite), Left	1	Pc	1	2,128	94039910
	9255211	9255211	Drawer Side Profile (Anthracite), Right	1	Pc	1	2,128	94039910
	9255825	9255825	Design Profile (Anthracite)	2	Pc	2	292	83024200
	9255838	9255838	Front Panel Connector for drawer side profile	4	Pc	4	1,496	39169090
	9257694	9257694	Rear Panel Connector (Anthracite), Left	1	Pc	1	450	83024200
	9257695	9257695	Rear Panel Connector (Anthracite), Right	1	Pc	1	450	83024200
	9257702	9257702	Rear Panel Stabilizer	3	Pc	3	39	39263090
	9123080	9123080	Front Stabilizer	1	Pc	1	438	39263090
	9303772	9303772	Quadro You Drawer runner-30kg, Left	1	Pc	1	1,425	83024200
	9303773	9303773	Quadro You Drawer runner-30kg, Right	1	Pc	1	1,425	83024200
	9257705	9257705	Branding clip with Hettich Logo Anthracite	1	Pc	1	40	39269099
BOM Code	9343374						10,311	

	<b>AvanTech – 450 mm (30 Kg) Full Extn. Silent</b>							
	9255212	9255212	Drawer Side Profile (Anthracite), Left	1	Pc	1	2,210	94039910
	9255213	9255213	Drawer Side Profile (Anthracite), Right	1	Pc	1	2,210	94039910
	9255826	9255826	Design Profile (Anthracite)	2	Pc	2	276	83024200
	9255838	9255838	Front Panel Connector for drawer side profile	4	Pc	4	1,496	39169090
	9257694	9257694	Rear Panel Connector (Anthracite), Left	1	Pc	1	450	83024200
	9257695	9257695	Rear Panel Connector (Anthracite), Right	1	Pc	1	450	83024200
	9257702	9257702	Rear Panel Stabilizer	3	Pc	3	39	39263090
	9123080	9123080	Front Stabilizer	1	Pc	1	438	39263090
	9303776	9303776	Quadro You Drawer runner-30kg, Left	1	Pc	1	1,485	83024200
	9303777	9303777	Quadro You Drawer runner-30kg, Right	1	Pc	1	1,485	83024200
	9257705	9257705	Branding clip with Hettich logo (Anthracite)	1	Pc	1	40	39269099
BOM Code	9343337						10,579	



	<b>AvanTech – 500 mm (30 Kg) Full Extn. Silent</b>							
	9255214	9255214	Drawer Side Profile (Anthracite), Left	1	Pc	1	2,242	94039910
	9255215	9255215	Drawer Side Profile (Anthracite), Right	1	Pc	1	2,242	94039910
	9255827	9255827	Design Profile (Anthracite)	2	Pc	2	276	83024200
	9255838	9255838	Front Panel Connector for drawer side profile	4	Pc	4	1,496	39169090
	9257694	9257694	Rear Panel Connector (Anthracite), Left	1	Pc	1	450	83024200
	9257695	9257695	Rear Panel Connector (Anthracite), Right	1	Pc	1	450	83024200
	9257702	9257702	Rear Panel Stabilizer	3	Pc	3	39	39263090
	9123080	9123080	Front Stabilizer	1	Pc	1	438	39263090
	9303780	9303780	Quadro You Drawer runner-30kg, Left	1	Pc	1	1,545	83024200
	9303781	9303781	Quadro You Drawer runner-30kg, Right	1	Pc	1	1,545	83024200
	9257705	9257705	Branding clip with Hettich logo (Anthracite)	1	Pc	1	40	39269099
BOM Code	9343356						10,763	

	<b>AvanTech – 550 mm (30 Kg) Full Extn. Silent</b>							
	9255216	9255216	Drawer Side Profile (Anthracite), Left	1	Pc	1	2,289	94039910
	9255217	9255217	Drawer Side Profile (Anthracite), Right	1	Pc	1	2,289	94039910
	9255828	9255828	Design Profile (Anthracite)	2	Pc	2	276	83024200
	9255838	9255838	Front Panel Connector for drawer side profile	4	Pc	4	1,496	39169090
	9257694	9257694	Rear Panel Connector (Anthracite), Left	1	Pc	1	450	83024200
	9257695	9257695	Rear Panel Connector (Anthracite), Right	1	Pc	1	450	83024200
	9257702	9257702	Rear Panel Stabilizer	3	Pc	3	39	39263090
	9123080	9123080	Front Stabilizer	1	Pc	1	438	39263090
	9303784	9303784	Quadro You Drawer runner-30kg, Left	1	Pc	1	1,665	83024200
	9303785	9303785	Quadro You Drawer runner-30kg, Right	1	Pc	1	1,665	83024200
	9257705	9257705	Branding clip with Hettich logo (Anthracite)	1	Pc	1	40	39269099
BOM Code	9343328						11,097	

# Drawer System: AvanTech

- ▶ Drawer height 251 mm
- ▶ Anthracite



Product	Article No.	SAP	Item Description	Qty.	Unit	PU	MRP	HS Code
	<b>AvanTech - 400 mm (30 Kg) Full Extn. Silent</b>							
	9255228	9255228	Drawer Side Profile (Anthracite), Left	1	Pc	1	3,876	94039010
	9255229	9255229	Drawer Side Profile (Anthracite), Right	1	Pc	1	3,876	94039010
	9255825	9255825	Design Profile (Anthracite)	2	Pc	2	292	39169090
	9255838	9255838	Front Panel Connector for drawer side profile	4	Pc	4	1,496	83024200
	9257696	9257696	Rear Panel Connector (Anthracite), Left	1	Pc	1	667	83024200
	9257697	9257697	Rear Panel Connector (Anthracite), Right	1	Pc	1	667	83024200
	9257702	9257702	Rear Panel Stabilizer	3	Pc	3	39	39263000
	9123080	9123080	Front Stabilizer	1	Pc	1	438	39263000
	9303772	9303772	Quadro You Drawer runner-30kg, Left	1	Pc	1	1,425	83024200
	9303773	9303773	Quadro You Drawer runner-30kg, Right	1	Pc	1	1,425	83024200
	9257705	9257705	Branding clip with Hettich Logo Anthracite	1	Pc	1	40	39269097
	9257887	9257887	Drawer front connector side profile, stabiliser	2	Pc	2	140	39269097
	BOM Code	9343375						14,381
	<b>AvanTech - 450 mm (30 Kg) Full Extn. Silent</b>							
	9255230	9255230	Drawer Side Profile (Anthracite), Left	1	Pc	1	3,740	94039010
	9255231	9255231	Drawer Side Profile (Anthracite), Right	1	Pc	1	3,740	94039010
	9255826	9255826	Design Profile (Anthracite)	2	Pc	2	276	39169090
	9255838	9255838	Front Panel Connector for drawer side profile	4	Pc	4	1,496	83024200
	9257696	9257696	Rear Panel Connector (Anthracite), Left	1	Pc	1	667	83024200
	9257697	9257697	Rear Panel Connector (Anthracite), Right	1	Pc	1	667	83024200
	9257702	9257702	Rear Panel Stabilizer	3	Pc	3	39	39263000
	9123080	9123080	Front Stabilizer	1	Pc	1	438	39263000
	9303776	9303776	Quadro You Drawer runner-30kg, Left	1	Pc	1	1,485	83024200
	9303777	9303777	Quadro You Drawer runner-30kg, Right	1	Pc	1	1,485	83024200
	9257705	9257705	Branding clip with Hettich Logo Anthracite	1	Pc	1	40	39269097
	9257887	9257887	Drawer front connector side profile, stabiliser	2	Pc	2	140	39269097
	BOM Code	9343338						14,213
	<b>AvanTech - 500 mm (30 Kg) Full Extn. Silent</b>							
	9255232	9255232	Drawer Side Profile (Anthracite), Left	1	Pc	1	3,797	94039010
	9255233	9255233	Drawer Side Profile (Anthracite), Right	1	Pc	1	3,797	94039010
	9255827	9255827	Design Profile (Anthracite)	2	Pc	2	276	39169090
	9255838	9255838	Front Panel Connector for drawer side profile	4	Pc	4	1,496	83024200
	9257696	9257696	Rear Panel Connector (Anthracite), Left	1	Pc	1	667	83024200
	9257697	9257697	Rear Panel Connector (Anthracite), Right	1	Pc	1	667	83024200
	9257702	9257702	Rear Panel Stabilizer	3	Pc	3	39	39263000
	9123080	9123080	Front Stabilizer	1	Pc	1	438	39263000
	9303780	9303780	Quadro You Drawer runner-30kg, Left	1	Pc	1	1,545	83024200
	9303781	9303781	Quadro You Drawer runner-30kg, Right	1	Pc	1	1,545	83024200
	9257705	9257705	Branding clip with Hettich Logo Anthracite	1	Pc	1	40	39269097
	9257887	9257887	Drawer front connector side profile, stabiliser	2	Pc	2	140	39269097
	BOM Code	9343357						14,447

## Drawer System: AvanTech

- ▶ Drawer height 251 mm
- ▶ Anthracite



Product	Article No.	SAP	Item Description	Qty.	Unit	PU	MRP	HS Code
<b>AvanTech - 550 mm (30 Kg) Full Extn. Silent</b>								
	9255234	9255234	Drawer Side Profile (Anthracite), Left	1	Pc	1	3,865	94039010
	9255235	9255235	Drawer Side Profile (Anthracite), Right	1	Pc	1	3,865	94039010
	9255828	9255828	Design Profile (Anthracite)	2	Pc	2	276	39169090
	9255838	9255838	Front Panel Connector for drawer side profile	4	Pc	4	1,496	83024200
	9257696	9257696	Rear Panel Connector (Anthracite), Left	1	Pc	1	667	83024200
	9257697	9257697	Rear Panel Connector (Anthracite), Right	1	Pc	1	667	83024200
	9257702	9257702	Rear Panel Stabilizer	3	Pc	3	39	39263000
	9123080	9123080	Front Stabilizer	1	Pc	1	438	39263000
	9303784	9303784	Quadro You Drawer runner-30kg, Left	1	Pc	1	1,665	83024200
	9303785	9303785	Quadro You Drawer runner-30kg, Right	1	Pc	1	1,665	83024200
	9257705	9257705	Branding clip with Hettich Logo Anthracite	1	Pc	1	40	39269097
	9257887	9257887	Drawer front connector side profile, stabiliser	2	Pc	2	140	39269097
	BOM Code	9343329						14,823

# Drawer System: AvanTech

- ▶ Inlay Drawer, Height 187 mm
- ▶ Anthracite



Product	Article No.	SAP	Item Description	Qty.	Unit	PU	MRP	HS Code
	<b>AvanTech Inlay - 400 mm (30 Kg) Full Extn. Silent</b>							
	9257161	9257161	Inlay Drawer Side Profile, Left	1	Pc	1	2,290	94039900
	9257162	9257162	Inlay Drawer Side Profile, Right	1	Pc	1	2,290	94039900
	9257257	9257257	Drawer front connector for inlay drawer side profile	2	Pc	2	836	83024200
	9268677	9268677	Adapter for Inlay drawer side profile	4	Pc	4	728	39169090
	9257694	9257694	Rear Panel Connector (Anthracite), Left	1	Pc	1	450	83024200
	9257695	9257695	Rear Panel Connector (Anthracite), Right	1	Pc	1	450	83024200
	9257702	9257702	Rear Panel Stabilizer	3	Pc	3	39	39263090
	9123080	9123080	Front Stabilizer	1	Pc	1	438	39263090
	9303772	9303772	Quadro You Drawer runner-30kg, Left	1	Pc	1	1,425	83024200
	9303773	9303773	Quadro You Drawer runner-30kg, Right	1	Pc	1	1,425	83024200
	9257705	9257705	Branding clip with Hettich Logo Anthracite	1	Pc	1	40	39269099
	BOM Code	9343322						10,411
	<b>AvanTech Inlay - 450 mm (30 Kg) Full Extn. Silent</b>							
	9257163	9257163	Inlay Drawer Side Profile, Left	1	Pc	1	2,420	94039900
	9257164	9257164	Inlay Drawer Side Profile, Right	1	Pc	1	2,420	94039900
	9257257	9257257	Drawer front connector for inlay drawer side profile	2	Pc	2	836	83024200
	9268677	9268677	Adapter for Inlay drawer side profile	4	Pc	4	728	39169090
	9257694	9257694	Rear Panel Connector (Anthracite), Left	1	Pc	1	450	83024200
	9257695	9257695	Rear Panel Connector (Anthracite), Right	1	Pc	1	450	83024200
	9257702	9257702	Rear Panel Stabilizer	3	Pc	3	39	39263090
	9123080	9123080	Front Stabilizer	1	Pc	1	438	39263090
	9303776	9303776	Quadro You Drawer runner-30kg, Left	1	Pc	1	1,485	83024200
	9303777	9303777	Quadro You Drawer runner-30kg, Right	1	Pc	1	1,485	83024200
	9257705	9257705	Branding clip with Hettich Logo Anthracite	1	Pc	1	40	39269099
	BOM Code	9343267						10,791
	<b>AvanTech Inlay - 500 mm (30 Kg) Full Extn. Silent</b>							
	9257165	9257165	Inlay Drawer Side Profile, Left	1	Pc	1	2,470	94039900
	9257166	9257166	Inlay Drawer Side Profile, Right	1	Pc	1	2,470	94039900
	9257257	9257257	Drawer front connector for inlay drawer side profile	2	Pc	2	836	83024200
	9268677	9268677	Adapter for Inlay drawer side profile	4	Pc	4	728	39169090
	9257694	9257694	Rear Panel Connector (Anthracite), Left	1	Pc	1	450	83024200
	9257695	9257695	Rear Panel Connector (Anthracite), Right	1	Pc	1	450	83024200
	9257702	9257702	Rear Panel Stabilizer	3	Pc	3	39	39263090
	9123080	9123080	Front Stabilizer	1	Pc	1	438	39263090
	9303780	9303780	Quadro You Drawer runner-30kg, Left	1	Pc	1	1,545	83024200
	9303781	9303781	Quadro You Drawer runner-30kg, Right	1	Pc	1	1,545	83024200
	9257705	9257705	Branding clip with Hettich Logo Anthracite	1	Pc	1	40	39269099
	BOM Code	9343270						11,011
	<b>AvanTech Inlay - 550 mm (30 Kg) Full Extn. Silent</b>							
	9257167	9257167	Inlay Drawer Side Profile, Left	1	Pc	1	2,510	94039900
	9257168	9257168	Inlay Drawer Side Profile, Right	1	Pc	1	2,510	94039900
	9257257	9257257	Drawer front connector for inlay drawer side profile	2	Pc	2	836	83024200
	9268677	9268677	Adapter for Inlay drawer side profile	4	Pc	4	728	39169090
	9257694	9257694	Rear Panel Connector (Anthracite), Left	1	Pc	1	450	83024200
	9257695	9257695	Rear Panel Connector (Anthracite), Right	1	Pc	1	450	83024200
	9257702	9257702	Rear Panel Stabilizer	3	Pc	3	39	39263090
	9123080	9123080	Front Stabilizer	1	Pc	1	438	39263090
	9303784	9303784	Quadro You Drawer runner-30kg, Left	1	Pc	1	1,665	83024200
	9303785	9303785	Quadro You Drawer runner-30kg, Right	1	Pc	1	1,665	83024200
	9257705	9257705	Branding clip with Hettich Logo Anthracite	1	Pc	1	40	39269099
	BOM Code	9343313						11,331



# Drawer System: AvanTech YOU

► Accessories



Product	Article No.	SAP	Item Description	Qty.	Unit	PU	MRP	HS Code
<b>AvanTech YOU Drawer Side Profile</b>								
	9255014	9255014	Drawer side Profile- D400 mm H101 mm, (Silver)-Left	1	Pc	1	1,342	94039010
	9255015	9255015	Drawer side Profile- D400 mm H101 mm, (Silver)-Right	1	Pc	1	1,342	94039010
	9255016	9255016	Drawer Side Profile- D450 mm H101 mm, (Silver), Left	1	Pc	1	1,485	94039010
	9255017	9255017	Drawer Side Profile- D450 mm H101 mm, (Silver), Right	1	Pc	1	1,485	94039010
	9255018	9255018	Drawer Side Profile- D500 mm H101 mm, (Silver), Left	1	Pc	1	1,518	94039010
	9255019	9255019	Drawer Side Profile- D500 mm H101 mm, (Silver), Right	1	Pc	1	1,518	94039010
	9255020	9255020	Drawer Side Profile- D550 mm H101 mm, (Silver), Left	1	Pc	1	1,541	94039010
	9255021	9255021	Drawer Side Profile- D550 mm H101 mm, (Silver), Right	1	Pc	1	1,541	94039010
	9255050	9255050	Drawer Side Profile-D400 mm H187 mm (Silver), Left	1	Pc	1	2,128	94039010
	9255051	9255051	Drawer Side Profile-D400 mm H187 mm (Silver), Right	1	Pc	1	2,128	94039010
	9255052	9255052	Drawer Side Profile-D450 mm H187 mm (Silver), Left	1	Pc	1	2,210	94039010
	9255053	9255053	Drawer Side Profile-D450 mm H187 mm (Silver), Right	1	Pc	1	2,210	94039010
	9255054	9255054	Drawer Side Profile-D500 mm H187 mm (Silver), Left	1	Pc	1	2,242	94039010
	9255055	9255055	Drawer Side Profile-D500 mm H187 mm (Silver), Right	1	Pc	1	2,242	94039010
	9255056	9255056	Drawer Side Profile-D550 mm H187 mm (Silver), Left	1	Pc	1	2,289	94039010
	9255057	9255057	Drawer Side Profile-D550 mm H187 mm (Silver), Right	1	Pc	1	2,289	94039010
	9255068	9255068	Drawer Side Profile-D400 mm H251 mm (Silver), Left	1	Pc	1	3,876	94039010
	9255069	9255069	Drawer Side Profile-D400 mm H251 mm (Silver), Right	1	Pc	1	3,876	94039010
	9255070	9255070	Drawer Side Profile-D450 mm H251 mm (Silver), Left	1	Pc	1	3,740	94039010
	9255071	9255071	Drawer Side Profile-D450 mm H251 mm (Silver), Right	1	Pc	1	3,740	94039010
	9255072	9255072	Drawer Side Profile-D500 mm H251 mm (Silver), Left	1	Pc	1	3,797	94039010
	9255073	9255073	Drawer Side Profile-D500 mm H251 mm (Silver), Right	1	Pc	1	3,797	94039010
	9255074	9255074	Drawer Side Profile-D550 mm H251 mm (Silver), Left	1	Pc	1	3,865	94039010
	9255075	9255075	Drawer Side Profile-D550 mm H251 mm (Silver), Right	1	Pc	1	3,865	94039010
	9255098	9255098	Drawer Side Profile-D500 mm H101 mm (White), Left	1	Pc	1	1,518	94039010
	9255099	9255099	Drawer Side Profile-D500 mm H101 mm (White), Right	1	Pc	1	1,518	94039010
	9255134	9255134	Drawer Side Profile-D500 mm H187 mm (White), Left	1	Pc	1	2,242	94039010
	9255135	9255135	Drawer Side Profile-D500 mm H187 mm (White), Right	1	Pc	1	2,242	94039010
	9255152	9255152	Drawer Side Profile-D500 mm H251 mm (White), Left	1	Pc	1	3,797	94039010
	9255153	9255153	Drawer Side Profile-D500 mm H251 mm (White), Right	1	Pc	1	3,797	94039010

# Drawer System: AvanTech YOU

► Accessories



Product	Article No.	SAP	Item Description	Qty.	Unit	PU	MRP	HS Code
<b>AvanTech YOU Drawer Side Profile</b>								
	9255174	9255174	Drawer Side Profile-D400 mm H101 mm (Anthracite), Left	1	Pc	1	1,342	94039010
	9255175	9255175	Drawer Side Profile-D400 mm H101 mm (Anthracite), Right	1	Pc	1	1,342	94039010
	9255176	9255176	Drawer Side Profile-D450 mm H101 mm (Anthracite), Left	1	Pc	1	1,485	94039010
	9255177	9255177	Drawer Side Profile-D450 mm H101 mm (Anthracite), Right	1	Pc	1	1,485	94039010
	9255178	9255178	Drawer Side Profile-D500 mm H101 mm (Anthracite), Left	1	Pc	1	1,518	94039010
	9255179	9255179	Drawer Side Profile-D500 mm H101 mm (Anthracite), Right	1	Pc	1	1,518	94039010
	9255180	9255180	Drawer Side Profile-D550 mm H101 mm (Anthracite), Left	1	Pc	1	1,541	94039010
	9255181	9255181	Drawer Side Profile-D550 mm H101 mm (Anthracite), Right	1	Pc	1	1,541	94039010
	9255210	9255210	Drawer Side Profile-D400 mm H187 mm (Anthracite), Left	1	Pc	1	2,128	94039010
	9255211	9255211	Drawer Side Profile-D400 mm H187 mm (Anthracite), Right	1	Pc	1	2,128	94039010
	9255212	9255212	Drawer Side Profile-D450 mm H187 mm (Anthracite), Left	1	Pc	1	2,210	94039010
	9255213	9255213	Drawer Side Profile-D450 mm H187 mm (Anthracite), Right	1	Pc	1	2,210	94039010
	9255214	9255214	Drawer Side Profile-D500 mm H187 mm (Anthracite), Left	1	Pc	1	2,242	94039010
	9255215	9255215	Drawer Side Profile-D500 mm H187 mm (Anthracite), Right	1	Pc	1	2,242	94039010
	9255216	9255216	Drawer Side Profile-D550 mm H187 mm (Anthracite), Left	1	Pc	1	2,289	94039010
	9255217	9255217	Drawer Side Profile-D550 mm H187 mm (Anthracite), Right	1	Pc	1	2,289	94039010
	9255228	9255228	Drawer Side Profile-D400 mm H251 mm (Anthracite), Left	1	Pc	1	3,876	94039010
	9255229	9255229	Drawer Side Profile-D400 mm H251 mm (Anthracite), Right	1	Pc	1	3,876	94039010
	9255230	9255230	Drawer Side Profile-D450 mm H251 mm (Anthracite), Left	1	Pc	1	3,740	94039010
	9255231	9255231	Drawer Side Profile-D450 mm H251 mm (Anthracite), Right	1	Pc	1	3,740	94039010
	9255232	9255232	Drawer Side Profile-D500 mm H251 mm (Anthracite), Left	1	Pc	1	3,797	94039010
	9255233	9255233	Drawer Side Profile-D500 mm H251 mm (Anthracite), Right	1	Pc	1	3,797	94039010
	9255234	9255234	Drawer Side Profile-D550 mm H251 mm (Anthracite), Left	1	Pc	1	3,865	94039010
	9255235	9255235	Drawer Side Profile-D550 mm H251 mm (Anthracite), Right	1	Pc	1	3,865	94039010

# Drawer System: AvanTech YOU

► Accessories



Product	Article No.	SAP	Item Description	Qty.	Unit	PU	MRP	HS Code
<b>AvanTech YOU Inlay Drawer Side Profile</b>								
	9257133	9257133	Inlay Drawer Side Profile-D400 mm H187 mm (Silver), Left	1	Pc	1	2,290	94039910
	9257134	9257134	Inlay Drawer Side Profile-D400 mm H187 mm (Silver), Right	1	Pc	1	2,290	94039910
	9257135	9257135	Inlay Drawer Side Profile-D450 mm H187 mm (Silver), Left	1	Pc	1	2,420	94039900
	9257136	9257136	Inlay Drawer Side Profile-D450 mm H187 mm (Silver), Right	1	Pc	1	2,420	94039900
	9257137	9257137	Inlay Drawer Side Profile-D500 mm H187 mm (Silver), Left	1	Pc	1	2,470	94039900
	9257138	9257138	Inlay Drawer Side Profile-D500 mm H187 mm (Silver), Right	1	Pc	1	2,470	94039010
	9257139	9257139	Inlay Drawer Side Profile-D550 mm H187 mm (Silver), Left	1	Pc	1	2,510	94039900
	9257140	9257140	Inlay Drawer Side Profile-D550 mm H187 mm (Silver), Right	1	Pc	1	2,510	94039900
	9257151	9257151	Inlay Drawer Side Profile-D500 mm H187 mm (White), Left	1	Pc	1	2,470	94039900
	9257152	9257152	Inlay Drawer Side Profile-D500 mm H187 mm (White), Right	1	Pc	1	2,470	94039900
	9257161	9257161	Inlay Drawer Side Profile-D400 mm H187 mm (Anthracite), Left	1	Pc	1	2,290	9257161
	9257162	9257162	Inlay Drawer Side Profile-D400 mm H187 mm (Anthracite), Right	1	Pc	1	2,290	9257162
	9257163	9257163	Inlay Drawer Side Profile-D450 mm H187 mm (Anthracite), Left	1	Pc	1	2,420	9257163
	9257164	9257164	Inlay Drawer Side Profile-D450 mm H187 mm (Anthracite), Right	1	Pc	1	2,420	9257164
	9257165	9257165	Inlay Drawer Side Profile-D500 mm H187 mm (Anthracite), Left	1	Pc	1	2,470	9257165
	9257166	9257166	Inlay Drawer Side Profile-D500 mm H187 mm (Anthracite), Right	1	Pc	1	2,470	9257166
	9257167	9257167	Inlay Drawer Side Profile-D550 mm H187 mm (Anthracite), Left	1	Pc	1	2,510	9257167
	9257168	9257168	Inlay Drawer Side Profile-D550 mm H187 mm (Anthracite), Right	1	Pc	1	2,510	9257168
<b>AvanTech YOU LED Profile Light</b>								
	9336473	9336473	AVT YOU LED profile, NW, D 400 MM, Finish Anthracite	1	Set	1	5,050	94054231
	9336474	9336474	AVT YOU LED profile, NW, D 450 MM, Finish Anthracite	1	Set	1	5,100	94054231
	9336475	9336475	AVT YOU LED profile, NW, D 500 MM, Finish Anthracite	1	Set	1	5,150	94054231
	9336476	9336476	AVT YOU LED profile, NW, D 550 MM, Finish Anthracite	1	Set	1	5,200	94054231
<b>AvanTech YOU LED Inlay Profile Light</b>								
	9336478	9336478	AVT YOU Inlay LED Set	1	Set	1	4,550	94054239

# Drawer System: AvanTech YOU

## ► Accessories







Product	Article No.	SAP	Item Description	Qty.	Unit	PU	MRP	HS Code
<b>Accessories</b>								
	9336477	9336477	AVT YOU Battery Pack	1	Pc	1	5,550	85044055
	9336479	9336479	AVT YOU Battery Pack Adapter	1	Pc	1	330	39263000
	9336480	9336480	AVT YOU Charging Cable	1	Pc	1	210	85444290
	9336481	9336481	AVT YOU Sensor Magnet	1	Pc	1	520	85051990
	9336482	9336482	AVT YOU Sensor Magnet - Inside Drawer	1	Pc	1	750	85051990
<b>AvanTech YOU Front Panel Connector for drawer side profile</b>								
	9255835	9255835	Front Panel Connector for 101 mm drawer side profile	1	Pc	1	403	83024200
	9255838	9255838	Front Panel Connector for 187/251 mm drawer side profile	1	Pc	1	748	83024200
<b>AvanTech YOU Front Panel Connector for Inlay drawer side profile</b>								
	9257257	9257257	Drawer Front Connector for Inlay drawer side profile	1	Pc	1	418	83024200
<b>AvanTech YOU Adapter for Inlay drawer side profile</b>								
	9268677	9268677	Adapter for Inlay drawer side profile (For using material thickness of 8 mm)	1	Pc	1	182	39169090
<b>AvanTech YOU Design Profiles</b>								
	9255762	9255762	Design Profile D400 mm Aluminium	1	Pc	100	240	39169090
	9255764	9255764	Design Profile D500 mm Aluminium	1	Pc	100	241	39169090
	9255773	9255773	Design Profile D500 mm Stainless Steel	1	Pc	100	241	39169090
	9255781	9255781	Design Profile D450 mm Chrome	1	Pc	100	265	39169090
	9255782	9255782	Design Profile D500 mm Chrome	1	Pc	100	260	39169090
	9255791	9255791	Design Profile D500 mm Oak	1	Pc	100	220	39169090
	9255800	9255800	Design Profile D500 mm Walnut	1	Pc	100	220	39169090



# Drawer System: AvanTech YOU

► Accessories



Product	Article No.	SAP	Item Description	Qty.	Unit	PU	MRP	HS Code
<b>AvanTech YOU Design Capes</b>								
	9257643	9257643	Design Cape H101 mm L2000 mm Aluminium	1	Pc	1	11,798	76042990
	9257645	9257645	Design Cape H187 mm L2000 mm Aluminium	1	Pc	1	19,467	76042990
	9257647	9257647	Design cape H101 mm L2000 mm stainless steel	1	Pc	1	15,360	76042990
	9257649	9257649	Design cape H187 mm L2000 mm stainless steel	1	Pc	1	23,880	76042990
	9283217	9283217	Design Cape H101 mm L2000 mm Oak	1	Pc	1	18,970	76042990
	9283221	9283221	Design Cape H187 mm L2000 mm Oak	1	Pc	1	32,500	76042990
	9283218	9283218	Design Cape H101 mm L2000 mm Copper	1	Pc	1	12,720	76042990
	9283223	9283223	Design Cape H187 mm L2000 mm Copper	1	Pc	1	19,300	76042990
	9283219	9283219	Design Cape H101 mm L2000 mm Concrete	1	Pc	1	15,125	76042990
	9283224	9283224	Design Cape H187 mm L2000 mm Concrete	1	Pc	1	13,155	76042990

# Drawer System: AvanTech YOU

► Accessories



Product	Article No.	SAP	Item Description	Qty.	Unit	PU	MRP	HS Code
<b>AvanTech YOU Rear Panel Connector</b>								
	9257666	9257666	Rear Panel Connector-H101 mm/ (Silver), Left	1	Pc	1	305	83024200
	9257667	9257667	Rear Panel Connector-H101 mm/ (Silver), Right	1	Pc	1	305	83024200
	9257670	9257670	Rear Panel Connector-H187 mm (Silver), Left	1	Pc	1	450	83024200
	9257671	9257671	Rear Panel Connector-H187 mm (Silver), Right	1	Pc	1	450	83024200
	9257672	9257672	Rear Panel Connector-H251 mm (Silver), Left	1	Pc	1	667	83024200
	9257673	9257673	Rear Panel Connector-H251 (Silver), Right	1	Pc	1	667	83024200
	9257678	9257678	Rear Panel Connector-H101 mm (White), Left	1	Pc	1	305	83024200
	9257679	9257679	Rear Panel Connector-H101 mm (White), Right	1	Pc	1	305	83024200
	9257682	9257682	Rear Panel Connector-H187 mm (White), Left	1	Pc	1	450	83024200
	9257683	9257683	Rear Panel Connector-H187 mm (White), Right	1	Pc	1	450	83024200
	9257684	9257684	Rear Panel Connector-H251 mm (White), Left	1	Pc	1	667	83024200
	9257685	9257685	Rear Panel Connector-H251 mm (White), Right	1	Pc	1	667	83024200
	9257690	9257690	Rear Panel Connector-H101 mm (Anthracite),Left	1	Pc	1	305	83024200
	9257691	9257691	Rear Panel Connector-H101 mm(Anthracite),Right	1	Pc	1	305	83024200
	9257694	9257694	Rear Panel Connector-H187 mm (Anthracite),Left	1	Pc	1	450	83024200
	9257695	9257695	Rear Panel Connector-H187mm(Anthracite),Right	1	Pc	1	450	83024200
	9257696	9257696	Rear Panel Connector-H251 (Anthracite), Left	1	Pc	1	667	83024200
	9257697	9257697	Rear Panel Connector-H251 (Anthracite), Right	1	Pc	1	667	83024200

# Drawer System: AvanTech YOU

► Accessories



Product	Article No.	SAP	Item Description	Qty.	Unit	PU	MRP	HS Code
<b>AvanTech YOU Design Profile</b>								
	9255807	9255807	Design Profile (Silver)- 400 mm	1	Pc	1	146	39169090
	9255808	9255808	Design Profile (Silver)- 450 mm	1	Pc	1	138	39169090
	9255809	9255809	Design Profile (Silver)- 500 mm	1	Pc	1	138	39169090
	9255810	9255810	Design Profile (Silver)- 550 mm	1	Pc	1	138	39169090
	9255818	9255818	Design Profile (White)- 500 mm	1	Pc	1	138	39169090
	9255825	9255825	Design Profile (Anthracite)- 400 mm	1	Pc	1	146	39169090
	9255826	9255826	Design Profile (Anthracite)- 450 mm	1	Pc	1	138	39169090
	9255827	9255827	Design Profile (Anthracite)- 500 mm	1	Pc	1	138	39169090
	9255828	9255828	Design Profile (Anthracite)- 550 mm	1	Pc	1	138	39169090
<b>AvanTech YOU Front Stabiliser</b>								
	9123080	9123080	Front stabiliser	1	Pc	1	438	39263000
<b>AvanTech YOU Rear Panel Stabiliser</b>								
	9257702	9257702	Rear Panel stabilizer	1	Pc	1	13	39263000
<b>AvanTech YOU Drawer front stabilizer for 251 mm drawer height</b>								
	9257887	9257887	Drawer front stabilizer for side profile, stabiliser	1	Pc	1	70	39269097
<b>AvanTech YOU Branding clip with Hettich Logo</b>								
	9257703	9257703	Branding clip with Hettich Logo- Silver	1	Pc	1	40	39269097
	9257704	9257704	Branding clip with Hettich logo (White)	1	Pc	1	40	39269097
	9257705	9257705	Branding clip with Hettich Logo Anthracite	1	Pc	1	40	39269097
<b>AvanTech YOU Actro YOU Runner</b>								
	9318175	9318175	Actro YOU runner Left, 40 kg- 400 mm	1	Pc	1	1,715	83024200
	9318176	9318176	Actro YOU runner Right, 40 kg- 400 mm	1	Pc	1	1,715	83024200
	9318177	9318177	Actro YOU runner Left, 40 kg- 450 mm	1	Pc	1	1,750	83024200
	9318178	9318178	Actro YOU runner Right, 40 kg- 450 mm	1	Pc	1	1,750	83024200
	9318179	9318179	Actro YOU runner Left, 40 kg- 500 mm	1	Pc	1	1,771	83024200
	9318180	9318180	Actro YOU runner Right, 40 kg- 500 mm	1	Pc	1	1,771	83024200
	9318181	9318181	Actro YOU runner Left, 40 kg- 550 mm	1	Pc	1	1,886	83024200
	9318182	9318182	Actro YOU runner Right, 40 kg- 550 mm	1	Pc	1	1,886	83024200
	9257013	9257013	Actro YOU runner Left, 70 kg- 450 mm	1	Pc	1	2,291	83024200
	9257014	9257014	Actro YOU runner Right, 70 kg- 450 mm	1	Pc	1	2,291	83024200
	9257017	9257017	Actro YOU runner Left, 70 kg- 500 mm	1	Pc	1	2,319	83024200
	9257018	9257018	Actro YOU runner Right, 70 kg- 500 mm	1	Pc	1	2,319	83024200
	9257021	9257021	Actro YOU runner Left, 70 kg- 550 mm	1	Pc	1	2,438	83024200
	9257022	9257022	Actro YOU runner Right, 70 kg- 550 mm	1	Pc	1	2,438	83024200

# Drawer System: AvanTech YOU

► Accessories







Product	Article No.	SAP	Item Description	Qty.	Unit	PU	MRP	HS Code
<b>AvanTech Quadro YOU runner</b>								
	9303772	9303772	Quadro YOU runner Left, 30 kg- 400 mm	1	Pc	1	1,425	83024200
	9303773	9303773	Quadro YOU runner Right, 30 kg- 400 mm	1	Pc	1	1,425	83024200
	9303776	9303776	Quadro YOU runner Left, 30 kg- 450 mm	1	Pc	1	1,485	83024200
	9303777	9303777	Quadro YOU runner Right, 30 kg- 450 mm	1	Pc	1	1,485	83024200
	9303780	9303780	Quadro YOU runner Left, 30 kg- 500 mm	1	Pc	1	1,545	83024200
	9303781	9303781	Quadro YOU runner Right, 30 kg- 500 mm	1	Pc	1	1,545	83024200
	9303784	9303784	Quadro YOU runner Left, 30 kg- 550 mm	1	Pc	1	1,665	83024200
	9303785	9303785	Quadro YOU runner Right, 30 kg- 550 mm	1	Pc	1	1,665	83024200
<b>AvanTech YOU Push to Open Silent Components</b>								
	9257892	9257892	Push to Open Silent component for Actro You/ 40 Kg	1	Pc	1	4,430	39263000
	9257893	9257893	Push to Open Silent component for Actro You/ 70 Kg	1	Pc	1	4,430	39263000
	9236718	9236718	Synchronisation bar 2000 mm	1	Pc	1	730	76042100
	9221295	9221295	Connector	1	Pc	1	105	39269097
<b>OrgaTray 630 (Powder Coated Steel Cutlery)</b>								
	9278320	9278320	OrgaTray 630 for depth 550 mm Anthracite (Can be used in both Silver and Anthracite finish drawer sets)	1	Pc	1	5,770	73269098
	9278332	9278332	OrgaTray 630 for 500 mm depth White	1	Pc	1	5,550	73269098
<b>Anti-Slip Mat for AvanTech YOU</b>								
	<b>Anti-slip mat - Classic (5 m roll)</b>							
	9209580	9209580	500mm NL PVC, antracite	1	Pc	1	7,111	39269097
	<b>Anti-slip mat - Hard Chequered (5 m roll)</b>							
	9290041	9290041	Anti slip mat W5000 D500 Silver	1	Set	1	2,140	39169090
	9290042	9290042	Anti slip mat W5000 D550 Silver	1	Set	1	2,420	39169090
	9290053	9290053	Anti slip mat W5000 D500 Anthracite	1	Set	1	2,140	39169090
9290054	9290054	Anti slip mat W5000 D550 Anthracite	1	Set	1	2,450	39169090	
	<b>Anti-slip mat - Soft Fine Chequered (5 m roll)</b>							
	9290045	9290045	Anti slip mat W5000 D500 Silver	1	Set	1	5,200	39169090
	9290057	9290057	Anti slip mat W5000 D500 Anthracite	1	Set	1	5,200	39169090
9290058	9290058	Anti slip mat W5000 D550 Anthracite	1	Set	1	5,730	39169090	
	<b>Anti-slip mat- Big Dots (5 m roll)</b>							
	9290061	9290061	Anti slip mat W5000 D500 Anthracite	1	Set	1	4,980	39169090



# Drawer System: ArciTech

► Drawer height 94 mm



Product	Article No.	SAP	Item Description	Qty.	Unit	PU	HS Code
	<b>ArciTech Silver 450 mm, Height 94 mm, 40 kg</b>						
	9121205	9121205	Drawer side profile, L	1	Pc	1	94039010
	9121206	9121206	Drawer side profile, R	1	Pc	1	94039010
	9123005	9123005	Cover Cap	2	Pc	2	39269097
	9121827	9121827	Rear panel Connector, L	1	Pc	1	83024200
	9121828	9121828	Rear panel Connector, R	1	Pc	1	83024200
	9123011	9123011	Screw-On Front Connector	2	Pc	2	83024200
	9239283	9239283	Actro runner, L	1	Pc	1	83024200
	9239284	9239284	Actro runner, R	1	Pc	1	83024200
BOM-Code	9243114	Total Set	MRP: 6,640				83021090
	<b>ArciTech Silver 500 mm, Height 94 mm, 40 kg</b>						
	9121207	9121207	Drawer side profile, L	1	Pc	1	94039010
	9121208	9121208	Drawer side profile, R	1	Pc	1	94039010
	9123005	9123005	Cover Cap	2	Pc	2	39269097
	9121827	9121827	Rear panel Connector, L	1	Pc	1	83024200
	9121828	9121828	Rear panel Connector, R	1	Pc	1	83024200
	9123011	9123011	Screw-On Front Connector	2	Pc	2	83024200
	9239287	9239287	Actro runner, L	1	Pc	1	83024200
	9239288	9239288	Actro runner, R	1	Pc	1	83024200
BOM-Code	9243115	Total Set	MRP: 6,640				83021090
	<b>ArciTech Silver 550 mm, Height 94 mm, 40 kg</b>						
	9121209	9121209	Drawer side profile, L	1	Pc	1	94039010
	9121210	9121210	Drawer side profile, R	1	Pc	1	94039010
	9123005	9123005	Cover Cap	2	Pc	2	39269097
	9121827	9121827	Rear panel Connector, L	1	Pc	1	83024200
	9121828	9121828	Rear panel Connector, R	1	Pc	1	83024200
	9123011	9123011	Screw-On Front Connector	2	Pc	2	83024200
	9239293	9239293	Actro runner, L	1	Pc	1	83024200
	9239294	9239294	Actro runner, R	1	Pc	1	83024200
BOM-Code	9243116	Total Set	MRP: 6,880				83021090
	<b>ArciTech Silver 450 mm, Height 94 mm, 60 kg</b>						
	9121205	9121205	Drawer side profile, L	1	Pc	1	94039010
	9121206	9121206	Drawer side profile, R	1	Pc	1	94039010
	9123005	9123005	Cover Cap	2	Pc	2	39269097
	9121827	9121827	Rear panel Connector, L	1	Pc	1	83024200
	9121828	9121828	Rear panel Connector, R	1	Pc	1	83024200
	9123011	9123011	Screw-On Front Connector	2	Pc	2	83024200
	9239285	9239285	Actro runner, L	1	Pc	1	83024200
	9239286	9239286	Actro runner, R	1	Pc	1	83024200
BOM-Code	9243117	Total Set	MRP: 7,660				83021090

# Drawer System: ArciTech

▶ Drawer height 94 mm & Narrow Pullout



Product	Article No.	SAP	Item Description	MRP	Qty.	Unit	PU	HS Code
	<b>ArciTech Silver 500 mm, Height 94 mm, 70 kg</b>							
	9121207	9121207	Drawer side profile, L		1	Pc	1	94039010
	9121208	9121208	Drawer side profile, R		1	Pc	1	94039010
	9123005	9123005	Cover Cap		2	Pc	2	39269097
	9121827	9121827	Rear panel Connector, L		1	Pc	1	83024200
	9121828	9121828	Rear panel Connector, R		1	Pc	1	83024200
	9123011	9123011	Screw-On Front Connector		2	Pc	2	83024200
	9239289	9239289	Actro runner, L		1	Pc	1	83024200
	9239290	9239290	Actro runner, R		1	Pc	1	83024200
BOM-Code	9243118	Total Set		7,660				83021090
	<b>ArciTech Silver 550 mm, Height 94 mm, 70 kg</b>							
	9121209	9121209	Drawer side profile, L		1	Pc	1	94039010
	9121210	9121210	Drawer side profile, R		1	Pc	1	94039010
	9123005	9123005	Cover Cap		2	Pc	2	39269097
	9121827	9121827	Rear panel Connector, L		1	Pc	1	83024200
	9121828	9121828	Rear panel Connector, R		1	Pc	1	83024200
	9123011	9123011	Screw-On Front Connector		2	Pc	2	83024200
	9239295	9239295	Actro runner, L		1	Pc	1	83024200
	9239296	9239296	Actro runner, R		1	Pc	1	83024200
BOM-Code	9243119	Total Set		7,900				83021090
	<b>ArciTech Silver 650 mm, Height 94 mm, 70 kg</b>							
	9121211	9121211	Drawer side profile, L		1	Pc	1	94039010
	9121212	9121212	Drawer side profile, R		1	Pc	1	94039010
	9123005	9123005	Cover Cap		2	Pc	2	39269097
	9121827	9121827	Rear panel Connector, L		1	Pc	1	83024200
	9121828	9121828	Rear panel Connector, R		1	Pc	1	83024200
	9123011	9123011	Screw-On Front Connector		2	Pc	2	83024200
	9239301	9239301	Actro runner, L		1	Pc	1	83024200
	9239302	9239302	Actro runner, R		1	Pc	1	83024200
BOM-Code	9243120	Total Set		8,420				83021090
	<b>ArciTech Narrow Pullout units NL 500 mm</b>							
	9332349	9332349	ArciTech Narrow Pullout (Height 94+186mm)/ Silver/ 20 Kg/ Depth 500 mm	11,476				83021090

# Drawer System: ArciTech

▶ Drawer height 186 mm





Product	Article No.	SAP	Item Description	Qty.	Unit	PU	HS Code
	<b>ArciTech Silver 450 mm pot &amp; pan with railing, Height 186 mm, 40 kg</b>						
	9121205	9121205	Drawer side profile, L	1	Pc	1	94039010
	9121206	9121206	Drawer side profile, R	1	Pc	1	94039010
	9123005	9123005	Cover Cap	2	Pc	2	39269097
	9121843	9121843	Rear panel Connector, L	1	Pc	1	83024200
	9121844	9121844	Rear panel Connector, R	1	Pc	1	83024200
	9123011	9123011	Screw-On Front Connector	2	Pc	2	83024200
	9239283	9239283	Actro runner, L	1	Pc	1	83024200
	9239284	9239284	Actro runner, R	1	Pc	1	83024200
	9121993	9121993	Lengthwise Railing, L	1	Pc	1	73269098
	9121994	9121994	Lengthwise Railing, R	1	Pc	1	73269098
	9127011	9127011	Screw-On Railing Connector	2	Pc	2	39263000
BOM-Code	9243154	Total Set	MRP: 7,920				83021090
	<b>ArciTech Silver 500 mm pot &amp; pan with railing, Height 186 mm, 40 kg</b>						
	9121207	9121207	Drawer side profile, L	1	Pc	1	94039010
	9121208	9121208	Drawer side profile, R	1	Pc	1	94039010
	9123005	9123005	Cover Cap	2	Pc	2	39269097
	9121843	9121843	Rear panel Connector, L	1	Pc	1	83024200
	9121844	9121844	Rear panel Connector, R	1	Pc	1	83024200
	9123011	9123011	Screw-On Front Connector	2	Pc	2	83024200
	9239287	9239287	Actro runner, L	1	Pc	1	83024200
	9239288	9239288	Actro runner, R	1	Pc	1	83024200
	9122003	9122003	Lengthwise Railing, L	1	Pc	1	73269098
	9122004	9122004	Lengthwise Railing, R	1	Pc	1	73269098
	9127011	9127011	Screw-On Railing Connector	2	Pc	2	39263000
BOM-Code	9243155	Total Set	MRP: 7,920				83021090
	<b>ArciTech Silver 550 mm pot &amp; pan with railing, Height 186 mm, 40 kg</b>						
	9121209	9121209	Drawer side profile, L	1	Pc	1	94039010
	9121210	9121210	Drawer side profile, R	1	Pc	1	94039010
	9123005	9123005	Cover Cap	2	Pc	2	39269097
	9121843	9121843	Rear panel Connector, L	1	Pc	1	83024200
	9121844	9121844	Rear panel Connector, R	1	Pc	1	83024200
	9123011	9123011	Screw-On Front Connector	2	Pc	2	83024200
	9239293	9239293	Actro runner, L	1	Pc	1	83024200
	9239294	9239294	Actro runner, R	1	Pc	1	83024200
	9122013	9122013	Lengthwise Railing, L	1	Pc	1	73269098
	9122014	9122014	Lengthwise Railing, R	1	Pc	1	73269098
	9127011	9127011	Screw-On Railing Connector	2	Pc	2	39263000
BOM-Code	9243156	Total Set	MRP: 8,160				83021090
	<b>ArciTech Silver 450 mm pot &amp; pan with railing, Height 186 mm, 60 kg</b>						
	9121205	9121205	Drawer side profile, L	1	Pc	1	94039010
	9121206	9121206	Drawer side profile, R	1	Pc	1	94039010
	9123005	9123005	Cover Cap	2	Pc	2	39269097
	9121843	9121843	Rear panel Connector, L	1	Pc	1	83024200
	9121844	9121844	Rear panel Connector, R	1	Pc	1	83024200
	9123011	9123011	Screw-On Front Connector	2	Pc	2	83024200
	9239285	9239285	Actro runner, L	1	Pc	1	83024200
	9239286	9239286	Actro runner, R	1	Pc	1	83024200
	9121993	9121993	Lengthwise Railing, L	1	Pc	1	73269098
	9121994	9121994	Lengthwise Railing, R	1	Pc	1	73269098
	9127011	9127011	Screw-On Railing Connector	2	Pc	2	39263000
BOM-Code	9243157	Total Set	MRP: 8,940				83021090

# Drawer System: ArciTech

► Drawer height 186 mm



Product	Article No.	SAP	Item Description	Qty.	Unit	PU	HS Code
	<b>ArciTech Silver 500 mm pot &amp; pan with railing, Height 186 mm, 70 kg</b>						
	9121207	9121207	Drawer side profile, L	1	Pc	1	94039010
	9121208	9121208	Drawer side profile, R	1	Pc	1	94039010
	9123005	9123005	Cover Cap	2	Pc	2	39269097
	9121843	9121843	Rear panel Connector, L	1	Pc	1	83024200
	9121844	9121844	Rear panel Connector, R	1	Pc	1	83024200
	9123011	9123011	Screw-On Front Connector	2	Pc	2	83024200
	9239289	9239289	Actro runner, L	1	Pc	1	83024200
	9239290	9239290	Actro runner, R	1	Pc	1	83024200
	9122003	9122003	Lengthwise Railing, L	1	Pc	1	73269098
	9122004	9122004	Lengthwise Railing, R	1	Pc	1	73269098
	9127011	9127011	Screw-On Railing Connector	2	Pc	2	39263000
BOM-Code	9243158	Total Set	MRP: 8,940				83021090
	<b>ArciTech Silver 550 mm pot &amp; pan with railing, Height 186 mm, 70 kg</b>						
	9121209	9121209	Drawer side profile, L	1	Pc	1	94039010
	9121210	9121210	Drawer side profile, R	1	Pc	1	94039010
	9123005	9123005	Cover Cap	2	Pc	2	39269097
	9121843	9121843	Rear panel Connector, L	1	Pc	1	83024200
	9121844	9121844	Rear panel Connector, R	1	Pc	1	83024200
	9123011	9123011	Screw-On Front Connector	2	Pc	2	83024200
	9239295	9239295	Actro runner, L	1	Pc	1	83024200
	9239296	9239296	Actro runner, R	1	Pc	1	83024200
	9122013	9122013	Lengthwise Railing, L	1	Pc	1	73269098
	9122014	9122014	Lengthwise Railing, R	1	Pc	1	73269098
	9127011	9127011	Screw-On Railing Connector	2	Pc	2	39263000
BOM-Code	9243159	Total Set	MRP: 9,180				83021090
	<b>ArciTech Silver 650 mm pot &amp; pan with railing, Height 186 mm, 70 kg</b>						
	9121211	9121211	Drawer side profile, L	1	Pc	1	94039010
	9121212	9121212	Drawer side profile, R	1	Pc	1	94039010
	9123005	9123005	Cover Cap	2	Pc	2	39269097
	9121843	9121843	Rear panel Connector, L	1	Pc	1	83024200
	9121844	9121844	Rear panel Connector, R	1	Pc	1	83024200
	9123011	9123011	Screw-On Front Connector	2	Pc	2	83024200
	9239301	9239301	Actro runner, L	1	Pc	1	83024200
	9239302	9239302	Actro runner, R	1	Pc	1	83024200
	9122033	9122033	Lengthwise Railing, L	1	Pc	1	73269098
	9122034	9122034	Lengthwise Railing, R	1	Pc	1	73269098
	9127011	9127011	Screw-On Railing Connector	2	Pc	2	39263000
BOM-Code	9243160	Total Set	MRP: 9,860				83021090





# Drawer System: ArciTech

► Drawer height 94 mm



Product	Article No.	SAP	Item Description	Qty.	Unit	PU	HS Code
	<b>ArciTech White 450 mm, Height 94 mm, 40 kg</b>						
	9121247	9121247	Drawer side profile, L	1	Pc	1	94039010
	9121248	9121248	Drawer side profile, R	1	Pc	1	94039010
	9123006	9123006	Cover Cap	2	Pc	2	39269097
	9121829	9121829	Rear panel Connector, L	1	Pc	1	83024200
	9121830	9121830	Rear panel Connector, R	1	Pc	1	83024200
	9123011	9123011	Screw-On Front Connector	2	Pc	2	83024200
	9239283	9239283	Actro runner, L	1	Pc	1	83024200
	9239284	9239284	Actro runner, R	1	Pc	1	83024200
BOM-Code	9243124	Total Set				MRP: 6,640	83021090
	<b>ArciTech White 500 mm, Height 94 mm, 40 kg</b>						
	9121249	9121249	Drawer side profile, L	1	Pc	1	94039010
	9121250	9121250	Drawer side profile, R	1	Pc	1	94039010
	9123006	9123006	Cover Cap	2	Pc	2	39269097
	9121829	9121829	Rear panel Connector, L	1	Pc	1	83024200
	9121830	9121830	Rear panel Connector, R	1	Pc	1	83024200
	9123011	9123011	Screw-On Front Connector	2	Pc	2	83024200
	9239287	9239287	Actro runner, L	1	Pc	1	83024200
	9239288	9239288	Actro runner, R	1	Pc	1	83024200
BOM-Code	9243125	Total Set				MRP: 6,640	83021090
	<b>ArciTech White 550 mm, Height 94 mm, 40 kg</b>						
	9121251	9121251	Drawer side profile, L	1	Pc	1	94039010
	9121252	9121252	Drawer side profile, R	1	Pc	1	94039010
	9123006	9123006	Cover Cap	2	Pc	2	39269097
	9121829	9121829	Rear panel Connector, L	1	Pc	1	83024200
	9121830	9121830	Rear panel Connector, R	1	Pc	1	83024200
	9123011	9123011	Screw-On Front Connector	2	Pc	2	83024200
	9239293	9239293	Actro runner, L	1	Pc	1	83024200
	9239294	9239294	Actro runner, R	1	Pc	1	83024200
BOM-Code	9243126	Total Set				MRP: 6,880	83021090
	<b>ArciTech White 450 mm, Height 94 mm, 60 kg</b>						
	9121247	9121247	Drawer side profile, L	1	Pc	1	94039010
	9121248	9121248	Drawer side profile, R	1	Pc	1	94039010
	9123006	9123006	Cover Cap	2	Pc	2	39269097
	9121829	9121829	Rear panel Connector, L	1	Pc	1	83024200
	9121830	9121830	Rear panel Connector, R	1	Pc	1	83024200
	9123011	9123011	Screw-On Front Connector	2	Pc	2	83024200
	9239285	9239285	Actro runner, L	1	Pc	1	83024200
	9239286	9239286	Actro runner, R	1	Pc	1	83024200
BOM-Code	9243127	Total Set				MRP: 7,660	83021090

# Drawer System: ArciTech

► Drawer height 94 mm & Narrow Pullout







Product	Article No.	SAP	Item Description	MRP	Qty.	Unit	PU	HS Code
	<b>ArciTech White 500 mm, Height 94 mm, 70 kg</b>							
	9121249	9121249	Drawer side profile, L		1	Pc	1	94039010
	9121250	9121250	Drawer side profile, R		1	Pc	1	94039010
	9123006	9123006	Cover Cap		2	Pc	2	39269097
	9121829	9121829	Rear panel Connector, L		1	Pc	1	83024200
	9121830	9121830	Rear panel Connector, R		1	Pc	1	83024200
	9123011	9123011	Screw-On Front Connector		2	Pc	2	83024200
	9239289	9239289	Actro runner, L		1	Pc	1	83024200
	9239290	9239290	Actro runner, R		1	Pc	1	83024200
BOM-Code	9243128	Total Set		7,660				83021090
	<b>ArciTech White 550 mm, Height 94 mm, 70 kg</b>							
	9121251	9121251	Drawer side profile, L		1	Pc	1	94039010
	9121252	9121252	Drawer side profile, R		1	Pc	1	94039010
	9123006	9123006	Cover Cap		2	Pc	2	39269097
	9121829	9121829	Rear panel Connector, L		1	Pc	1	83024200
	9121830	9121830	Rear panel Connector, R		1	Pc	1	83024200
	9123011	9123011	Screw-On Front Connector		2	Pc	2	83024200
	9239295	9239295	Actro runner, L		1	Pc	1	83024200
	9239296	9239296	Actro runner, R		1	Pc	1	83024200
BOM-Code	9243129	Total Set		7,900				83021090
	<b>ArciTech Narrow Pullout units NL 500 mm</b>							
9332371	9332371	ArciTech Narrow Pullout (Height 94+186mm)/ White/ 20 Kg/ Depth 500 mm	11,976				83021090	



# Drawer System: ArciTech

► Drawer height 186 mm



Product	Article No.	SAP	Item Description	Qty.	Unit	PU	HS Code
	<b>ArciTech White 450 mm pot &amp; pan with railing, Height 186 mm, 40 kg</b>						
	9121247	9121247	Drawer side profile, L	1	Pc	1	94039010
	9121248	9121248	Drawer side profile, R	1	Pc	1	94039010
	9123006	9123006	Cover Cap	2	Pc	2	39269097
	9121845	9121845	Rear panel Connector, L	1	Pc	1	83024200
	9121846	9121846	Rear panel Connector, R	1	Pc	1	83024200
	9123011	9123011	Screw-On Front Connector	2	Pc	2	83024200
	9239283	9239283	Actro runner, L	1	Pc	1	83024200
	9239284	9239284	Actro runner, R	1	Pc	1	83024200
	9121997	9121997	Lengthwise Railing, L	1	Pc	1	73269098
	9121998	9121998	Lengthwise Railing, R	1	Pc	1	73269098
	9127011	9127011	Screw-On Railing Connector	2	Pc	2	39263000
BOM-Code	9243164	Total Set	MRP: 7,920				83021090
	<b>ArciTech White 500 mm pot &amp; pan with railing, Height 186 mm, 40 kg</b>						
	9121249	9121249	Drawer side profile, L	1	Pc	1	94039010
	9121250	9121250	Drawer side profile, R	1	Pc	1	94039010
	9123006	9123006	Cover Cap	2	Pc	2	39269097
	9121845	9121845	Rear panel Connector, L	1	Pc	1	83024200
	9121846	9121846	Rear panel Connector, R	1	Pc	1	83024200
	9123011	9123011	Screw-On Front Connector	2	Pc	2	83024200
	9239287	9239287	Actro runner, L	1	Pc	1	83024200
	9239288	9239288	Actro runner, R	1	Pc	1	83024200
	9122007	9122007	Lengthwise Railing, L	1	Pc	1	73269098
	9122008	9122008	Lengthwise Railing, R	1	Pc	1	73269098
	9127011	9127011	Screw-On Railing Connector	2	Pc	2	39263000
BOM-Code	9243165	Total Set	MRP: 7,920				83021090
	<b>ArciTech White 550 mm pot &amp; pan with railing, Height 186 mm, 40 kg</b>						
	9121251	9121251	Drawer side profile, L	1	Pc	1	94039010
	9121252	9121252	Drawer side profile, R	1	Pc	1	94039010
	9123006	9123006	Cover Cap	2	Pc	2	39269097
	9121845	9121845	Rear panel Connector, L	1	Pc	1	83024200
	9121846	9121846	Rear panel Connector, R	1	Pc	1	83024200
	9123011	9123011	Screw-On Front Connector	2	Pc	2	83024200
	9239293	9239293	Actro runner, L	1	Pc	1	83024200
	9239294	9239294	Actro runner, R	1	Pc	1	83024200
	9122017	9122017	Lengthwise Railing, L	1	Pc	1	94039010
	9122018	9122018	Lengthwise Railing, R	1	Pc	1	94039010
	9127011	9127011	Screw-On Railing Connector	2	Pc	2	39263000
BOM-Code	9243166	Total Set	MRP: 8,160				83021090
	<b>ArciTech White 450 mm pot &amp; pan with railing, Height 186 mm, 60 kg</b>						
	9121247	9121247	Drawer side profile, L	1	Pc	1	94039010
	9121248	9121248	Drawer side profile, R	1	Pc	1	94039010
	9123006	9123006	Cover Cap	2	Pc	2	39269097
	9121845	9121845	Rear panel Connector, L	1	Pc	1	83024200
	9121846	9121846	Rear panel Connector, R	1	Pc	1	83024200
	9123011	9123011	Screw-On Front Connector	2	Pc	2	83024200
	9239285	9239285	Actro runner, L	1	Pc	1	83024200
	9239286	9239286	Actro runner, R	1	Pc	1	83024200
	9121997	9121997	Lengthwise Railing, L	1	Pc	1	73269098
	9121998	9121998	Lengthwise Railing, R	1	Pc	1	73269098
	9127011	9127011	Screw-On Railing Connector	2	Pc	2	39263000
BOM-Code	9243167	Total Set	MRP: 8,940				83021090

# Drawer System: ArciTech

► Drawer height 186 mm



Product	Article No.	SAP	Item Description	Qty.	Unit	PU	HS Code
<b>ArciTech White 500 mm pot &amp; pan with railing, Height 186 mm, 70 kg</b>							
	9121249	9121249	Drawer side profile, L	1	Pc	1	94039010
	9121250	9121250	Drawer side profile, R	1	Pc	1	94039010
	9123006	9123006	Cover Cap	2	Pc	2	39269097
	9121845	9121845	Rear panel Connector, L	1	Pc	1	83024200
	9121846	9121846	Rear panel Connector, R	1	Pc	1	83024200
	9123011	9123011	Screw-On Front Connector	2	Pc	2	83024200
	9239289	9239289	Actro runner, L	1	Pc	1	83024200
	9239290	9239290	Actro runner, R	1	Pc	1	83024200
	9122007	9122007	Lengthwise Railing, L	1	Pc	1	73269098
	9122008	9122008	Lengthwise Railing, R	1	Pc	1	73269098
9127011	9127011	Screw-On Railing Connector	2	Pc	2	39263000	
BOM-Code	9243168	Total Set	MRP: 8,940				83021090
<b>ArciTech White 550 mm pot &amp; pan with railing, Height 186 mm, 70 kg</b>							
	9121251	9121251	Drawer side profile, L	1	Pc	1	94039010
	9121252	9121252	Drawer side profile, R	1	Pc	1	94039010
	9123006	9123006	Cover Cap	2	Pc	2	39269097
	9121845	9121845	Rear panel Connector, L	1	Pc	1	83024200
	9121846	9121846	Rear panel Connector, R	1	Pc	1	83024200
	9123011	9123011	Screw-On Front Connector	2	Pc	2	83024200
	9239295	9239295	Actro runner, L	1	Pc	1	83024200
	9239296	9239296	Actro runner, R	1	Pc	1	83024200
	9122017	9122017	Lengthwise Railing, L	1	Pc	1	94039010
	9122018	9122018	Lengthwise Railing, R	1	Pc	1	94039010
9127011	9127011	Screw-On Railing Connector	2	Pc	2	39263000	
BOM-Code	9243169	Total Set	MRP: 9,180				83021090





# Drawer System: ArciTech

► Drawer height 94 mm



Product	Article No.	SAP	Item Description	Qty.	Unit	PU	HS Code
	<b>ArciTech Anthracite 450 mm, Height 94 mm, 40 kg</b>						
	9121289	9121289	Drawer side profile, L	1	Pc	1	94039010
	9121290	9121290	Drawer side profile, R	1	Pc	1	94039010
	9123005	9123005	Cover Cap	2	Pc	2	39269097
	9121831	9121831	Rear panel Connector, L	1	Pc	1	83024200
	9121832	9121832	Rear panel Connector, R	1	Pc	1	83024200
	9123011	9123011	Screw-On Front Connector	2	Pc	2	83024200
	9239283	9239283	Actro runner, L	1	Pc	1	83024200
	9239284	9239284	Actro runner, R	1	Pc	1	83024200
BOM-Code	9243134	Total Set	MRP: 6,640				83021090
	<b>ArciTech Anthracite 500 mm, Height 94 mm, 40 kg</b>						
	9121291	9121291	Drawer side profile, L	1	Pc	1	94039010
	9121292	9121292	Drawer side profile, R	1	Pc	1	94039010
	9123005	9123005	Cover Cap	2	Pc	2	39269097
	9121831	9121831	Rear panel Connector, L	1	Pc	1	83024200
	9121832	9121832	Rear panel Connector, R	1	Pc	1	83024200
	9123011	9123011	Screw-On Front Connector	2	Pc	2	83024200
	9239287	9239287	Actro runner, L	1	Pc	1	83024200
	9239288	9239288	Actro runner, R	1	Pc	1	83024200
BOM-Code	9243135	Total Set	MRP: 6,640				83021090
	<b>ArciTech Anthracite 550 mm, Height 94 mm, 40 kg</b>						
	9121293	9121293	Drawer side profile, L	1	Pc	1	94039010
	9121294	9121294	Drawer side profile, R	1	Pc	1	94039010
	9123005	9123005	Cover Cap	2	Pc	2	39269097
	9121831	9121831	Rear panel Connector, L	1	Pc	1	83024200
	9121832	9121832	Rear panel Connector, R	1	Pc	1	83024200
	9123011	9123011	Screw-On Front Connector	2	Pc	2	83024200
	9239293	9239293	Actro runner, L	1	Pc	1	83024200
	9239294	9239294	Actro runner, R	1	Pc	1	83024200
BOM-Code	9243136	Total Set	MRP: 6,680				83021090
	<b>ArciTech Anthracite 450 mm, Height 94 mm, 60 kg</b>						
	9121289	9121289	Drawer side profile, L	1	Pc	1	94039010
	9121290	9121290	Drawer side profile, R	1	Pc	1	94039010
	9123005	9123005	Cover Cap	2	Pc	2	39269097
	9121831	9121831	Rear panel Connector, L	1	Pc	1	83024200
	9121832	9121832	Rear panel Connector, R	1	Pc	1	83024200
	9123011	9123011	Screw-On Front Connector	2	Pc	2	83024200
	9239285	9239285	Actro runner, L	1	Pc	1	83024200
	9239286	9239286	Actro runner, R	1	Pc	1	83024200
BOM-Code	9243137	Total Set	MRP: 7,660				83021090

# Drawer System: ArciTech

► Drawer height 94 mm & Narrow Pullout



Product	Article No.	SAP	Item Description	MRP	Qty.	Unit	PU	HS Code
	<b>ArciTech Anthracite 500 mm, Height 94 mm, 70 kg</b>							
	9121291	9121291	Drawer side profile, L		1	Pc	1	94039010
	9121292	9121292	Drawer side profile, R		1	Pc	1	94039010
	9123005	9123005	Cover Cap		2	Pc	2	39269097
	9121831	9121831	Rear panel Connector, L		1	Pc	1	83024200
	9121832	9121832	Rear panel Connector, R		1	Pc	1	83024200
	9123011	9123011	Screw-On Front Connector		2	Pc	2	83024200
	9239289	9239289	Actro runner, L		1	Pc	1	83024200
	9239290	9239290	Actro runner, R		1	Pc	1	83024200
	BOM-Code	9243138	Total Set	7,660				83021090
	<b>ArciTech Anthracite 550 mm, Height 94 mm, 70 kg</b>							
	9121293	9121293	Drawer side profile, L		1	Pc	1	94039010
	9121294	9121294	Drawer side profile, R		1	Pc	1	94039010
	9123005	9123005	Cover Cap		2	Pc	2	39269097
	9121831	9121831	Rear panel Connector, L		1	Pc	1	83024200
	9121832	9121832	Rear panel Connector, R		1	Pc	1	83024200
	9123011	9123011	Screw-On Front Connector		2	Pc	2	83024200
	9239295	9239295	Actro runner, L		1	Pc	1	83024200
	9239296	9239296	Actro runner, R		1	Pc	1	83024200
	BOM-Code	9243139	Total Set	7,900				83021090
	<b>ArciTech Narrow Pullout units NL 500 mm</b>							
	9332370	9332370	ArciTech Narrow Pullout (Height 94+186mm)/ Anthracite/ 20 Kg/ Depth 500 mm	11,976				83021090



# Drawer System: ArciTech

► Drawer height 186 mm



Product	Article No.	SAP	Item Description	Qty.	Unit	PU	HS Code
	<b>ArciTech Anthracite 450 mm pot &amp; pan with railing, Height 186 mm, 40 kg</b>						
	9121289	9121289	Drawer side profile, L	1	Pc	1	94039010
	9121290	9121290	Drawer side profile, R	1	Pc	1	94039010
	9123005	9123005	Cover Cap	2	Pc	2	39269097
	9121847	9121847	Rear panel Connector, L	1	Pc	1	83024200
	9121848	9121848	Rear panel Connector, R	1	Pc	1	83024200
	9123011	9123011	Screw-On Front Connector	2	Pc	2	83024200
	9239283	9239283	Actro runner, L	1	Pc	1	83024200
	9239284	9239284	Actro runner, R	1	Pc	1	83024200
	9121995	9121995	Lengthwise Railing, L	1	Pc	1	73269098
	9121996	9121996	Lengthwise Railing, R	1	Pc	1	73269098
9127011	9127011	Screw-On Railing Connector	2	Pc	2	39263000	
BOM-Code	9243174	Total Set	MRP: 7,920				83021090
	<b>ArciTech Anthracite 500 mm pot &amp; pan with railing, Height 186 mm, 40 kg</b>						
	9121291	9121291	Drawer side profile, L	1	Pc	1	94039010
	9121292	9121292	Drawer side profile, R	1	Pc	1	94039010
	9123005	9123005	Cover Cap	2	Pc	2	39269097
	9121847	9121847	Rear panel Connector, L	1	Pc	1	83024200
	9121848	9121848	Rear panel Connector, R	1	Pc	1	83024200
	9123011	9123011	Screw-On Front Connector	2	Pc	2	83024200
	9239287	9239287	Actro runner, L	1	Pc	1	83024200
	9239288	9239288	Actro runner, R	1	Pc	1	83024200
	9122005	9122005	Lengthwise Railing, L	1	Pc	1	73269098
	9122006	9122006	Lengthwise Railing, R	1	Pc	1	73269098
9127011	9127011	Screw-On Railing Connector	2	Pc	2	39263000	
BOM-Code	9243175	Total Set	MRP: 7,920				83021090
	<b>ArciTech Anthracite 550 mm pot &amp; pan with railing, Height 186 mm, 40 kg</b>						
	9121293	9121293	Drawer side profile, L	1	Pc	1	94039010
	9121294	9121294	Drawer side profile, R	1	Pc	1	94039010
	9123005	9123005	Cover Cap	2	Pc	2	39269097
	9121847	9121847	Rear panel Connector, L	1	Pc	1	83024200
	9121848	9121848	Rear panel Connector, R	1	Pc	1	83024200
	9123011	9123011	Screw-On Front Connector	2	Pc	2	83024200
	9239293	9239293	Actro runner, L	1	Pc	1	83024200
	9239294	9239294	Actro runner, R	1	Pc	1	83024200
	9122015	9122015	Lengthwise Railing, L	1	Pc	1	73269098
	9122016	9122016	Lengthwise Railing, R	1	Pc	1	73269098
9127011	9127011	Screw-On Railing Connector	2	Pc	2	39263000	
BOM-Code	9243176	Total Set	MRP: 8,160				83021090
	<b>ArciTech Anthracite 450 mm pot &amp; pan with railing, Height 186 mm, 60 kg</b>						
	9121289	9121289	Drawer side profile, L	1	Pc	1	94039010
	9121290	9121290	Drawer side profile, R	1	Pc	1	94039010
	9123005	9123005	Cover Cap	2	Pc	2	39269097
	9121847	9121847	Rear panel Connector, L	1	Pc	1	83024200
	9121848	9121848	Rear panel Connector, R	1	Pc	1	83024200
	9123011	9123011	Screw-On Front Connector	2	Pc	2	83024200
	9239285	9239285	Actro runner, L	1	Pc	1	83024200
	9239286	9239286	Actro runner, R	1	Pc	1	83024200
	9121995	9121995	Lengthwise Railing, L	1	Pc	1	73269098
	9121996	9121996	Lengthwise Railing, R	1	Pc	1	73269098
9127011	9127011	Screw-On Railing Connector	2	Pc	2	39263000	
BOM-Code	9243177	Total Set	MRP: 8,940				83021090

# Drawer System: ArciTech

► Drawer height 186 mm



Product	Article No.	SAP	Item Description	Qty.	Unit	PU	HS Code
	<b>ArciTech Anhracite 500 mm pot &amp; pan with railing, Height 186 mm, 70 kg</b>						
	9121291	9121291	Drawer side profile, L	1	Pc	1	94039010
	9121292	9121292	Drawer side profile, R	1	Pc	1	94039010
	9123005	9123005	Cover Cap	2	Pc	2	39269097
	9121847	9121847	Rear panel Connector, L	1	Pc	1	83024200
	9121848	9121848	Rear panel Connector, R	1	Pc	1	83024200
	9123011	9123011	Screw-On Front Connector	2	Pc	2	83024200
	9239289	9239289	Actro runner, L	1	Pc	1	83024200
	9239290	9239290	Actro runner, R	1	Pc	1	83024200
	9122005	9122005	Lengthwise Railing, L	1	Pc	1	73269098
	9122006	9122006	Lengthwise Railing, R	1	Pc	1	73269098
	9127011	9127011	Screw-On Railing Connector	2	Pc	2	39263000
BOM-Code	9243178	Total Set	MRP: 8,940				83021090
	<b>ArciTech Anthracite 550 mm pot &amp; pan with railing, Height 186 mm, 70 kg</b>						
	9121293	9121293	Drawer side profile, L	1	Pc	1	94039010
	9121294	9121294	Drawer side profile, R	1	Pc	1	94039010
	9123005	9123005	Cover Cap	2	Pc	2	39269097
	9121847	9121847	Rear panel Connector, L	1	Pc	1	83024200
	9121848	9121848	Rear panel Connector, R	1	Pc	1	83024200
	9123011	9123011	Screw-On Front Connector	2	Pc	2	83024200
	9239295	9239295	Actro runner, L	1	Pc	1	83024200
	9239296	9239296	Actro runner, R	1	Pc	1	83024200
	9122015	9122015	Lengthwise Railing, L	1	Pc	1	73269098
	9122016	9122016	Lengthwise Railing, R	1	Pc	1	73269098
	9127011	9127011	Screw-On Railing Connector	2	Pc	2	39263000
BOM-Code	9243179	Total Set	MRP: 9,180				83021090





# Drawer System: ArciTech

## ► Accessories



Product	Article No.	SAP	Item Description	Qty.	Unit	PU	MRP	HS Code	
	<b>Accessories for ArciTech Silver 500 / 550 mm</b>								
	9122920	9122920	ArciTech Topside- 500 mm	1	Set	1	3,320	73269098	
	9122988	9122988	ArciTech DesignSide- 500 mm	1	Set	1	2,440	70200080	
	9122989	9122989	ArciTech DesignSide- 550 mm	1	Set	1	2,480	70200080	
	9122973	9122973	ArciTech DesignSide Adapter	1	Set	1	1,860	83024200	
	9122998	9122998	DesignSide Connectors	1	Set	1	1,630	83024200	
	<b>ArciTech Silver, front panel, Internal Drawer height 94 / 186 mm</b>								
	9122799	9122799	94 / 600 mm	1	Pc	15	3,800	94039010	
	9122853	9122853	186 / 600 mm	1	Pc	15	5,120	94039010	
	9122801	9122801	94 / 900 mm	1	Pc	15	5,570	94039010	
	9122855	9122855	186 / 900 mm	1	Pc	15	6,890	94039010	
	9192204	9192204	Aluminium front panel, L 2000 mm	1	Pc	1	4,990	76042990	
	9182706	9182706	Railing for Aluminium front panel	1	Pc	1	2,982	73066192	
	9123083	9123083	Front connector H 94	1	Set	15	1,860	83024200	
	9123089	9123089	Front connector H 186	1	Set	15	3,070	83024200	
	<b>Accessories for ArciTech White 500 / 550 mm</b>								
	9122988	9122988	ArciTech Design side- 500 mm	1	Set	1	2,440	70200080	
	9122989	9122989	ArciTech Design side- 550 mm	1	Set	1	2,480	70200080	
	9122975	9122975	ArciTech Design side Adapter	1	Set	15	1,860	83024200	
	9122998	9122998	Design side Connectors	1	Set	1	1,630	83024200	
	<b>Accessories for ArciTech Anthracite 500 / 550 mm</b>								
	9122921	9122921	ArciTech Topside- 500 mm	1	Set	1	3,320	73269098	
	9122988	9122988	ArciTech DesignSide- 500 mm	1	Set	1	2,440	70200080	
	9122989	9122989	ArciTech DesignSide- 550 mm	1	Set	1	2,480	70200080	
	9122974	9122974	ArciTech DesignSide Adapter	1	Set	1	1,860	83024200	
	9122998	9122998	DesignSide Connectors	1	Set	1	1,630	83024200	
	<b>ArciTech Anthracite, front panel, Internal drawer height 94 / 186 mm</b>								
	9140089	9140089	94 / 600 mm	1	Set	15	3,800	94039010	
	9140107	9140107	186 / 600 mm	1	Set	15	5,120	94039010	
	9192205	9192205	Aluminium front panel, L 2000 mm	1	Pc	1	5,675	76042990	
	9182712	9182712	Railing for Aluminium front panel	1	Set	1	2,982	73066192	
	9140121	9140121	Front connector H 94	1	Set	15	1,854	83024200	
	9140123	9140123	Connector for Front H186 - Anthracite	1	Set	1	3,070	83024200	



# Drawer System: ArciTech

## ► Accessories



Product	Article No.	SAP	Item Description	Qty.	Unit	PU	MRP	HS Code
	<b>OrgaTray 570 Silver (Adjustable Partition Cutlery)</b>							
	9134992	9134992	For NL 500 mm depth, cabinet width 600 mm	1	Set	1	2,790	39249000
	9134994	9134994	For NL 500 mm depth, cabinet width 900 mm	1	Set	1	4,970	39249000
	<b>OrgaTray 440 Trimmable (Fixed Partition Cutlery) - Silver</b>							
	9194924	9194924	Tray width 501-600 mm, depth 380-440 mm	1	Pc	1	800	39249000
	9194933	9194933	Tray width 301-350 mm, depth 441-520 mm	1	Pc	1	580	39249090
	9194934	9194934	Tray width 351-400 mm, depth 441-520 mm	1	Pc	1	600	39249000
	9194935	9194935	Tray width 401-450 mm, depth 441-520 mm	1	Pc	1	630	39249000
	9194936	9194936	Tray width 451-500 mm, depth 441-520 mm	1	Pc	1	700	39249000
	9194937	9194937	Tray width 501-600 mm, depth 441-520 mm	1	Pc	1	830	39249000
	9194938	9194938	Tray width 601-700 mm, Depth 441- 520 mm	1	Pc	1	1,450	39249000
	9194939	9194939	Tray width 701-800 mm, depth 441-520 mm	1	Pc	1	1,590	39249000
	9194940	9194940	Tray width 801-900 mm, depth 441-520 mm	1	Pc	1	1,670	39249000
	<b>OrgaTray 440 Trimmable (Fixed Partition Cutlery) - Anthracite</b>							
	9194995	9194995	Tray width 301-350 mm, depth 441-520 mm	1	Pc	1	580	39249000
	9194996	9194996	Tray width 351-400 mm, depth 441-520 mm	1	Pc	1	600	39249090
	9194997	9194997	Tray width 401-450 mm, depth 441-520 mm	1	Pc	1	630	39249000
	9194998	9194998	Tray width 451-500 mm, depth 441-520 mm	1	Pc	1	700	39249000
	9194999	9194999	Tray width 501-600 mm, depth 441-520 mm	1	Pc	1	830	39249000
	9195000	9195000	Tray width 601-700 mm, Depth 441- 520 mm	1	Pc	1	1,450	39249000
	9195001	9195001	Tray width 701-800 mm, depth 441-520 mm	1	Pc	1	1,590	39249000
	9195002	9195002	Tray width 801-900 mm, depth 441-520 mm	1	Pc	1	1,670	39249000
	9195004	9195004	Tray width 1091-1150 mm, depth 441-520 mm	1	Pc	1	2,355	39249000
	<b>Knife Holder &amp; Spice Rack</b>							
	9226100	9226100	Knife Holder	1	Pc	1	3,320	94039900
	9079207	9079207	Spice Rack	1	Pc	1	4,680	44199090
	<b>OrgaStore 400 customised width</b>							
	9182706	9182706	Crosswise railing 2000 mm silver	1	Pc	1	2,982	73066192
	9182222	9182222	Adapter anthracite	1	Pc	1	180	39269097
	9182225	9182225	Lengthwise divider anthracite	1	Pc	1	410	39269097
	9182712	9182712	Crosswise railing 2000 mm anthracite	1	Pc	1	2,982	73066192
	<b>OrgaTray 630 (Powder Coated Steel Cutlery)</b>							
	9278320	9278320	OrgaTray 630 for depth 550 mm Anthracite	1	Pc	1	5,770	73239900
	9278332	9278332	OrgaTray 630 for 500 mm depth White	1	Pc	1	5,550	73269098

# Drawer System: ArciTech

## ► Accessories



Product	Article No.	SAP	Item Description	Qty.	Unit	PU	MRP	HS Code
<b>Anti-slip mat for ArciTech</b>								
	<b>Anti-slip mat - Classic (5 m roll)</b>							
	9209580	9209580	500 mm NL PVC, Anthracite	1	Pc	1	7,111	39269097
	<b>Anti-slip mat - Hard Chequered (5 m roll)</b>							
	9290041	9290041	Anti slip mat W5000 D500 Silver	1	Pc	1	2,140	39181090
	9290042	9290042	Anti slip mat W5000 D550 Silver	1	Pc	1	2,420	39181090
	9290053	9290053	Anti slip mat W5000 D500 Anthracite	1	Pc	1	2,140	39181090
	9290054	9290054	Anti slip mat W5000 D550 Anthracite	1	Pc	1	2,450	39181090
	<b>Anti-slip mat - Soft Fine Chequered (5 m roll)</b>							
	9290045	9290045	Anti slip mat W5000 D500 Silver	1	Pc	1	5,200	39181090
	9290057	9290057	Anti slip mat W5000 D500 Anthracite	1	Pc	1	5,200	39181090
	9290058	9290058	Anti slip mat W5000 D550 Anthracite	1	Pc	1	5,730	39181090
	<b>Anti-slip mat- Big Dots (5 m roll)</b>							
	9290061	9290061	Anti slip mat W5000 D500 Anthracite	1	Pc	1	4,980	39181090
	<b>ArciTech Support Materials</b>							
	9123080	9123080	Front Stabiliser (Recommended for >= 600 mm front fascia width)	1	Pc	1	438	39263000
	<b>ArciTech Back Panel Connector</b>							
	9121851	9121851	Back panel connector Silver Left-218 mm	1	Pc	1	502	83024200
	9121852	9121852	Back panel connector Silver Right--218 mm	1	Pc	1	502	83024200
	9121867	9121867	Back panel connector Silver Left-282 mm	1	Pc	1	614	83024200
	9121868	9121868	Back panel connector Silver Right--282 mm	1	Pc	1	614	83024200
	9121853	9121853	Back panel connector White Left-218 mm	1	Pc	1	416	83024200
	9121854	9121854	Back panel connector White Right -218 mm	1	Pc	1	416	83024200
	9121855	9121855	Back panel connector Anthracite Left-218 mm	1	Pc	1	416	83024200
9121856	9121856	Back panel connector Anthracite Right -218 mm	1	Pc	1	416	83024200	
	<b>ArciTech Support Materials</b>							
	9123011	9123011	ArciTech Screw On Connector	1	Pc	1	170	83024200

# Drawer System: ArciTech

## ► Accessories



Product	Article No.	SAP	Item Description	Qty.	Unit	PU	MRP	HS Code
<b>ArciTech Drawer Side Profile</b>								
	<b>Finish : Silver</b>							
	9121205	9121205	ArciTech - 450 mm-Drawer side profile, L - Silver	1	Pc	1	1,050	94039010
	9121206	9121206	ArciTech - 450 mm-Drawer side profile, R - Silver	1	Pc	1	1,050	94039010
	9121207	9121207	ArciTech - 500 mm-Drawer side profile, L - Silver	1	Pc	1	1,050	94039010
	9121208	9121208	ArciTech - 500 mm-Drawer side profile, R - Silver	1	Pc	1	1,050	94039010
	9121209	9121209	ArciTech - 550 mm-Drawer side profile, L - Silver	1	Pc	1	1,170	94039010
	9121210	9121210	ArciTech - 550 mm-Drawer side profile, R - Silver	1	Pc	1	1,170	94039010
	9121211	9121211	ArciTech - 650 mm-Drawer side profile, L - Silver	1	Pc	1	1,220	94039010
	9121212	9121212	ArciTech - 650 mm-Drawer side profile, R - Silver	1	Pc	1	1,220	94039010
	<b>Finish : White</b>							
	9121247	9121247	ArciTech - 450 mm-Drawer side profile, L-White	1	Pc	1	1,050	94039010
	9121248	9121248	ArciTech - 450 mm-Drawer side profile, R-White	1	Pc	1	1,050	94039010
	9121249	9121249	ArciTech - 500 mm-Drawer side profile, L-White	1	Pc	1	1,050	94039010
	9121250	9121250	ArciTech - 500 mm-Drawer side profile, R-White	1	Pc	1	1,050	94039010
	9121251	9121251	ArciTech - 550 mm-Drawer side profile, L-White	1	Pc	1	1,170	94039010
	9121252	9121252	ArciTech - 550 mm-Drawer side profile, R-White	1	Pc	1	1,170	94039010
	<b>Finish : Anthracite</b>							
	9121289	9121289	ArciTech-450 mm-Drawer side profile, L-Anthracite	1	Pc	1	1,050	94039010
	9121290	9121290	ArciTech-450 mm-Drawer side profile, R-Anthracite	1	Pc	1	1,050	94039010
	9121291	9121291	ArciTech-500 mm-Drawer side profile, L-Anthracite	1	Pc	1	1,050	94039010
	9121292	9121292	ArciTech-500 mm-Drawer side profile, R-Anthracite	1	Pc	1	1,050	94039010
	9121293	9121293	ArciTech-550 mm-Drawer side profile, L-Anthracite	1	Pc	1	1,170	94039010
	9121294	9121294	ArciTech-550 mm-Drawer side profile, R-Anthracite	1	Pc	1	1,170	94039010
<b>Lengthwise railing</b>								
	<b>Finish : Silver</b>							
	9121993	9121993	Lengthwise Railing, L - 450 mm - Silver	1	Pc	1	490	73269098
	9121994	9121994	Lengthwise Railing, R - 450 mm - Silver	1	Pc	1	490	73269098
	9122003	9122003	Lengthwise Railing, L - 500 mm - Silver	1	Pc	1	490	73269098
	9122004	9122004	Lengthwise Railing, R - 500 mm - Silver	1	Pc	1	490	73269098
	9122013	9122013	Lengthwise Railing, L - 550 mm - Silver	1	Pc	1	490	73269098
	9122014	9122014	Lengthwise Railing, R - 550 mm - Silver	1	Pc	1	490	73269098
	9122033	9122033	Lengthwise Railing, L - 650 mm - Silver	1	Pc	1	570	73269098
	9122034	9122034	Lengthwise Railing, R - 650 mm - Silver	1	Pc	1	570	73269098
	9127011	9127011	Screw-on Railing connector	1	Pc	1	50	39263000
	<b>Finish : White</b>							
	9121997	9121997	Lengthwise Railing, L - 450 mm - White	1	Pc	1	520	73269098
	9121998	9121998	Lengthwise Railing, R - 450 mm - White	1	Pc	1	520	73269098
	9122007	9122007	Lengthwise Railing, L - 500 mm - White	1	Pc	1	520	73269098
	9122008	9122008	Lengthwise Railing, R - 500 mm - White	1	Pc	1	520	73269098
	9122017	9122017	Lengthwise Railing, L - 550 mm - White	1	Pc	1	520	94039010
	9122018	9122018	Lengthwise Railing, R - 550 mm - White	1	Pc	1	520	94039010
	9127011	9127011	Screw-on Railing connector	1	Pc	1	50	39263000

# Drawer System: ArciTech

## ► Accessories



Product	Article No.	SAP	Item Description	Qty.	Unit	PU	MRP	HS Code
	<b>Finish : Anthracite</b>							
	9121995	9121995	Lengthwise Railing, L - 450 mm - Anthracite	1	Pc	1	520	73269098
	9121996	9121996	Lengthwise Railing, R - 450 mm - Anthracite	1	Pc	1	520	73269098
	9122005	9122005	Lengthwise Railing, L - 500 mm - Anthracite	1	Pc	1	520	73269098
	9122006	9122006	Lengthwise Railing, R - 500 mm - Anthracite	1	Pc	1	520	73269098
	9122015	9122015	Lengthwise Railing, L - 550 mm - Anthracite	1	Pc	1	520	73269098
	9122016	9122016	Lengthwise Railing, R - 550 mm - Anthracite	1	Pc	1	520	73269098
	9127011	9127011	Screw-on Railing connector	1	Pc	1	50	39263000
<b>Rear Panel Connector</b>								
	<b>Finish : Silver</b>							
	9121827	9121827	Rear panel Connector, L - 94 mm - Silver	1	Pc	1	330	83024200
	9121828	9121828	Rear panel Connector, R - 94 mm - Silver	1	Pc	1	330	83024200
	9121843	9121843	Rear panel Connector, L - 186 mm - Silver	1	Pc	1	430	83024200
	9121844	9121844	Rear panel Connector, R- 186 mm - Silver	1	Pc	1	430	83024200
	<b>Finish : White</b>							
	9121829	9121829	Rear panel Connector, L - 94 mm - White	1	Pc	1	330	83024200
	9121830	9121830	Rear panel Connector, R - 94 mm - White	1	Pc	1	330	83024200
	9121845	9121845	Rear panel Connector, L - 186 mm - White	1	Pc	1	400	83024200
	9121846	9121846	Rear panel Connector, R - 186 mm - White	1	Pc	1	400	83024200
	<b>Finish : Anthracite</b>							
	9121831	9121831	Rear panel Connector, L - 94 mm - Anthracite	1	Pc	1	330	83024200
	9121832	9121832	Rear panel Connector, R - 94 mm - Anthracite	1	Pc	1	330	83024200
	9121847	9121847	Rear panel Connector, L - 186 mm - Anthracite	1	Pc	1	400	83024200
	9121848	9121848	Rear panel Connector, R - 186 mm - Anthracite	1	Pc	1	400	83024200





# Drawer System: ArciTech

► Accessories



Product	Article No.	SAP	Item Description	Qty.	Unit	PU	MRP	HS Code
<b>ArciTech Cover Cap</b>								
	9123005	9123005	Cover Cap - Silver	2	Pc	2	80	39269097
	9123006	9123006	Cover Cap - White	2	Pc	2	80	39269097
	9123005	9123005	Cover Cap - Anthracite	2	Pc	2	80	39269097
<b>Push to open Silent opening system for ArciTech</b>								
	9241050	9241050	PTO Silent System Set up to 10 Kg - 40 Kg	1	Set	1	4,078	39263090
	9241051	9241051	PTO Silent System Set up to 20 Kg - 80 Kg	1	Set	1	4,078	39263000
<b>Synchronisation Mechanism for 600 mm and above drawer carcass widths</b>								
	9236718	9236718	Synchronisation Bar - 2000 mm	1	Pc	100	730	83024200
	9221295	9221295	Mid Connector	1	Pc	20	105	39269097
<b>Actro Runners</b>								
	<b>Actro Runners 40 kg</b>							
	9239283	9239283	Actro runner, 450 mm L - 40 Kg	1	Pc	1	1,730	83024200
	9239284	9239284	Actro runner, 450 mm R - 40 Kg	1	Pc	1	1,730	83024200
	9239287	9239287	Actro runner, 500 mm L - 40 Kg	1	Pc	1	1,730	83024200
	9239288	9239288	Actro runner, 500 mm R - 40 Kg	1	Pc	1	1,730	83024200
	9239293	9239293	Actro runner, 550 mm L - 40 Kg	1	Pc	1	1,730	83024200
	9239294	9239294	Actro runner, 550 mm R - 40 Kg	1	Pc	1	1,730	83024200
	<b>Actro Runners 70/60 kg</b>							
	9239285	9239285	Actro runner, 450 mm L - 60 Kg	1	Pc	1	2,240	83024200
	9239286	9239286	Actro runner, 450 mm R - 60 Kg	1	Pc	1	2,240	83024200
	9239289	9239289	Actro runner, 500 mm L - 70 Kg	1	Pc	1	2,240	83024200
	9239290	9239290	Actro runner, 500 mm R - 70 Kg	1	Pc	1	2,240	83024200
	9239295	9239295	Actro runner, 550 mm L - 70 Kg	1	Pc	1	2,240	83024200
	9239296	9239296	Actro runner, 550 mm R - 70 Kg	1	Pc	1	2,240	83024200
	9239301	9239301	Actro runner, 650 mm L - 70 Kg	1	Pc	1	2,450	83024200
9239302	9239302	Actro runner, 650 mm R - 70 Kg	1	Pc	1	2,450	83024200	









# Drawer System: InnoTech Atira

- ▶ Drawer height 70 mm
- ▶ Silver







Product	Article No.	SAP	Item Description	Qty.	Unit	PU	HS Code
	<b>InnoTech Atira - 350 mm (30 Kg) Full Extn. Silent</b>						
	9207690	9207690	Drawer side profile, L	1	Pc	1	94039010
	9207696	9207696	Drawer side profile, R	1	Pc	1	94039010
	1065191	1065191	Screw-On Front Connector	2	Pc	2	39263000
	45310-L	9126554	Quadro-V6	1	Pc	1	83024200
	45310-R	9126555	Quadro-V6	1	Pc	1	83024200
	1062501	1062501	Rear panel Connector, L	1	Pc	1	83024200
	1062502	1062502	Rear panel Connector, R	1	Pc	1	83024200
	9194646	9194646	Cover Cap Grey	2	Pc	2	39269097
BOM-Code	9249736	Total Set	MRP: 6,192				83021090
	<b>InnoTech Atira - 420 mm (30 Kg) Full Extn. Silent</b>						
	9207697	9207697	Drawer side profile, L	1	Pc	1	94039010
	9207699	9207699	Drawer side profile, R	1	Pc	1	94039010
	1065191	1065191	Screw-On Front Connector	2	Pc	2	39263000
	45311-L	9126558	Quadro-V6	1	Pc	1	83024200
	45311-R	9126559	Quadro-V6	1	Pc	1	83024200
	1062501	1062501	Rear panel Connector, L	1	Pc	1	83024200
	1062502	1062502	Rear panel Connector, R	1	Pc	1	83024200
	9194646	9194646	Cover Cap Hettich logo Grey Background	2	Pc	2	39269097
BOM-Code	9249738	Total Set	MRP: 6,164				83021090
	<b>InnoTech Atira - 470 mm (30 Kg) Full Extn. Silent</b>						
	9207700	9207700	Drawer side profile, L	1	Pc	1	94039010
	9207702	9207702	Drawer side profile, R	1	Pc	1	94039010
	1065191	1065191	Screw-On Front Connector	2	Pc	2	39263000
	45312-L	9126556	Quadro-V6	1	Pc	1	83024200
	45312-R	9126557	Quadro-V6	1	Pc	1	83024200
	1062501	1062501	Rear panel Connector, L	1	Pc	1	83024200
	1062502	1062502	Rear panel Connector, R	1	Pc	1	83024200
	9194646	9194646	Cover Cap Grey	2	Pc	2	39269097
BOM-Code	9243194	Total Set	MRP: 5,716				83021090
	<b>InnoTech Atira - 520 mm (30 Kg) Full Extn. Silent</b>						
	9207703	9207703	Drawer side profile, L	1	Pc	1	94039010
	9207704	9207704	Drawer side profile, R	1	Pc	1	94039010
	1065191	1065191	Screw-On Front Connector	2	Pc	2	39263000
	45313-L	9126562	Quadro-V6	1	Pc	1	83024200
	45313-R	9126563	Quadro-V6	1	Pc	1	83024200
	1062501	1062501	Rear panel Connector, L	1	Pc	1	83024200
	1062502	1062502	Rear panel Connector, R	1	Pc	1	83024200
	9194646	9194646	Cover Cap Grey	2	Pc	2	39269097
BOM-Code	9243195	Total Set	MRP: 5,880				83021090

## Drawer System: InnoTech Atira

- ▶ Drawer height 70 mm
- ▶ Silver





Product	Article No.	SAP	Item Description	Qty.	Unit	PU	HS Code
	<b>InnoTech Atira - 420 mm (50 Kg) Full Extn. Silent</b>						
	9207697	9207697	Drawer side profile, L	1	Pc	1	94039010
	9207699	9207699	Drawer side profile, R	1	Pc	1	94039010
	1065191	1065191	Screw-On Front Connector	2	Pc	2	39263000
	48360-L	9102862	Quadro-V6+	1	Pc	1	83024200
	48360-R	9102864	Quadro-V6+	1	Pc	1	83024200
	1062501	1062501	Rear panel Connector, L	1	Pc	1	83024200
	1062502	1062502	Rear panel Connector, R	1	Pc	1	83024200
	9194646	9194646	Cover Cap Grey	2	Pc	2	39269097
BOM-Code	9249741	Total Set	MRP: 7,243				83021090
	<b>InnoTech Atira - 470 mm (50 Kg) Full Extn. Silent</b>						
	9207700	9207700	Drawer side profile, L	1	Pc	1	94039010
	9207702	9207702	Drawer side profile, R	1	Pc	1	94039010
	1065191	1065191	Screw-On Front Connector	2	Pc	2	39263000
	48361-L	9133792	Quadro-V6	1	Pc	1	83024200
	48361-R	9133793	Quadro-V6	1	Pc	1	83024200
	1062501	1062501	Rear panel Connector, L	1	Pc	1	83024200
	1062502	1062502	Rear panel Connector, R	1	Pc	1	83024200
	9194646	9194646	Cover Cap Hettich logo Grey Background	2	Pc	2	39269097
BOM-Code	9249744	Total Set	MRP: 6,774				83021090
	<b>InnoTech Atira - 520 mm (50 Kg) Full Extn. Silent</b>						
	9207703	9207703	Drawer side profile, L	1	Pc	1	94039010
	9207704	9207704	Drawer side profile, R	1	Pc	1	94039010
	1065191	1065191	Screw-On Front Connector	2	Pc	2	39263000
	48362-L	9102868	Quadro-V6+	1	Pc	1	83024200
	48362-R	9102870	Quadro-V6+	1	Pc	1	83024200
	1062501	1062501	Rear panel Connector, L	1	Pc	1	83024200
	1062502	1062502	Rear panel Connector, R	1	Pc	1	83024200
	9194646	9194646	Cover Cap Grey	2	Pc	2	39269097
BOM-Code	9249747	Total Set	MRP: 7,022				83021090
	<b>InnoTech Atira - 620 mm (50 Kg) Full Extn. Silent</b>						
	9194402	9194402	Drawer side profile, L	1	Pc	1	94039010
	9194403	9194403	Drawer side profile, R	1	Pc	1	94039010
	1065191	1065191	Screw-On Front Connector	2	Pc	2	39263000
	40271-L	9126394	Quadro-V6+	1	Pc	1	83024200
	40271-R	9126395	Quadro-V6+	1	Pc	1	83024200
	1062501	1062501	Rear panel Connector, L	1	Pc	1	83024200
	1062502	1062502	Rear panel Connector, R	1	Pc	1	83024200
	9194646	9194646	Cover Cap Grey	2	Pc	2	39269097
BOM-Code	9249740	Total Set	MRP: 7,910				83021090

## Drawer System: InnoTech Atira

- ▶ Pot & pan drawer with railing, height 144 mm
- ▶ Silver



Product	Article No.	SAP	Item Description	Qty.	Unit	PU	HS Code
	<b>InnoTech Atira - 350 mm (30 Kg) Full Extn. Silent</b>						
	9207690	9207690	Drawer side profile H70 mm, L	1	Pc	1	94039010
	9207696	9207696	Drawer side profile H70 mm, R	1	Pc	1	94039010
	1065191	1065191	Screw-On Front Connector	2	Pc	2	39263000
	45310-L	9126554	Quadro-V6	1	Pc	1	83024200
	45310-R	9126555	Quadro-V6	1	Pc	1	83024200
	9194526	9194526	Lengthwise Railing 350 mm, L	1	Pc	1	73269098
	9194527	9194527	Lengthwise Railing 350 mm, R	1	Pc	1	73269098
	9002503	9002503	Railing Connector	2	Pc	2	39269097
	9007355	9007355	Rear panel Connector 144 mm, L	1	Pc	1	83024200
	9007356	9007356	Rear panel Connector 144 mm, R	1	Pc	1	83024200
	9194646	9194646	Cover Cap Grey	2	Pc	2	39269097
BOM-Code	9249735	Total Set	MRP: 7,208				83021090

	<b>InnoTech Atira - 420 mm (30 Kg) Full Extn. Silent</b>						
	9207697	9207697	Drawer side profile H70 mm, L	1	Pc	1	94039010
	9207699	9207699	Drawer side profile H70 mm, R	1	Pc	1	94039010
	1065191	1065191	Screw-On Front Connector	2	Pc	2	39263000
	45311-L	9126558	Quadro-V6	1	Pc	1	83024200
	45311-R	9126559	Quadro-V6	1	Pc	1	83024200
	9194528	9194528	Lengthwise Railing 420 mm, L	1	Pc	1	73269098
	9194529	9194529	Lengthwise Railing 420 mm, R	1	Pc	1	73269098
	9002503	9002503	Railing Connector	2	Pc	2	39269097
	9007355	9007355	Rear panel Connector 144 mm, L	1	Pc	1	83024200
	9007356	9007356	Rear panel Connector 144 mm, R	1	Pc	1	83024200
	9194646	9194646	Cover Cap Grey	2	Pc	2	39269097
BOM-Code	9249737	Total Set	MRP: 7,244				83021090

	<b>InnoTech Atira - 470 mm (30 Kg) Full Extn. Silent</b>						
	9207700	9207700	Drawer side profile H70 mm, L	1	Pc	1	94039010
	9207702	9207702	Drawer side profile H70 mm, R	1	Pc	1	94039010
	1065191	1065191	Screw-On Front Connector	2	Pc	2	39263000
	45312-L	9126556	Quadro-V6	1	Pc	1	83024200
	45312-R	9126557	Quadro-V6	1	Pc	1	83024200
	9194530	9194530	Lengthwise Railing 470 mm, L	1	Pc	1	73269098
	9194531	9194531	Lengthwise Railing 470 mm, R	1	Pc	1	73269098
	9002503	9002503	Railing Connector	2	Pc	2	39269097
	9007355	9007355	Rear panel Connector 144 mm, L	1	Pc	1	83024200
	9007356	9007356	Rear panel Connector 144 mm, R	1	Pc	1	83024200
	9194646	9194646	Cover Cap Grey	2	Pc	2	39269097
BOM-Code	9243196	Total Set	MRP: 6,824				83021090

## Drawer System: InnoTech Atira

- ▶ Pot & pan drawer with railing, height 144 mm
- ▶ Silver



Product	Article No.	SAP	Item Description	Qty.	Unit	PU	HS Code
	<b>InnoTech Atira - 520 mm (30 Kg) Full Extn. Silent</b>						
	9207703	9207703	Drawer side profile H70 mm, L	1	Pc	1	94039010
	9207704	9207704	Drawer side profile H70 mm, R	1	Pc	1	94039010
	1065191	1065191	Screw-On Front Connector	2	Pc	2	39263000
	45313-L	9126562	Quadro-V6	1	Pc	1	83024200
	45313-R	9126563	Quadro-V6	1	Pc	1	83024200
	9194532	9194532	Lengthwise Railing 520 mm, L	1	Pc	1	73269098
	9194533	9194533	Lengthwise Railing 520 mm, R	1	Pc	1	73269098
	9002503	9002503	Railing Connector	2	Pc	2	39269097
	9007355	9007355	Rear panel Connector 144 mm, L	1	Pc	1	83024200
	9007356	9007356	Rear panel Connector 144 mm, R	1	Pc	1	83024200
	9194646	9194646	Cover Cap Grey	2	Pc	2	39269097
	BOM-Code	9243197	Total Set	MRP: 6,988			

	<b>InnoTech Atira - 420 mm (50 Kg) Full Extn.Silent</b>						
	9207697	9207697	Drawer side profile H70 mm, L	1	Pc	1	94039010
	9207699	9207699	Drawer side profile H70 mm, R	1	Pc	1	94039010
	1065191	1065191	Screw-On Front Connector	2	Pc	2	39263000
	48360-L	9102862	Quadro-V6+	1	Pc	1	83024200
	48360-R	9102864	Quadro-V6+	1	Pc	1	83024200
	9194528	9194528	Lengthwise Railing 420 mm, L	1	Pc	1	73269098
	9194529	9194529	Lengthwise Railing 420 mm, R	1	Pc	1	73269098
	9002503	9002503	Railing Connector	2	Pc	2	39269097
	9007355	9007355	Rear panel Connector 144 mm, L	1	Pc	1	83024200
	9007356	9007356	Rear panel Connector 144 mm, R	1	Pc	1	83024200
	9194646	9194646	Cover Cap Grey	2	Pc	2	39269097
	BOM-Code	9249743	Total Set	MRP: 8,323			

	<b>InnoTech Atira - 470 mm (50 Kg) Full Extn. Silent</b>						
	9207700	9207700	Drawer side profile H70 mm, L	1	Pc	1	94039010
	9207702	9207702	Drawer side profile H70 mm, R	1	Pc	1	94039010
	1065191	1065191	Screw-On Front Connector	2	Pc	2	39263000
	48361-L	9133792	Quadro-V6+	1	Pc	1	83024200
	48361-R	9133793	Quadro-V6+	1	Pc	1	83024200
	9194530	9194530	Lengthwise Railing 470 mm, L	1	Pc	1	73269098
	9194531	9194531	Lengthwise Railing 470 mm, R	1	Pc	1	73269098
	9002503	9002503	Railing Connector	2	Pc	2	39269097
	9007355	9007355	Rear panel Connector 144 mm, L	1	Pc	1	83024200
	9007356	9007356	Rear panel Connector 144 mm, R	1	Pc	1	83024200
	9194646	9194646	Cover Cap Grey	2	Pc	2	39269097
	BOM-Code	9249745	Total Set	MRP: 7,950			

## Drawer System: InnoTech Atira

- ▶ Pot & pan drawer with railing, height 144 mm
- ▶ Silver



Product	Article No.	SAP	Item Description	Qty.	Unit	PU	HS Code
	<b>InnoTech Atira - 520 mm (50 Kg) Full Extn. Silent</b>						
	9207703	9207703	Drawer side profile H70 mm, L	1	Pc	1	94039010
	9207704	9207704	Drawer side profile H70 mm, R	1	Pc	1	94039010
	1065191	1065191	Screw-On Front Connector	2	Pc	2	39263000
	48362-L	9102868	Quadro-V6+	1	Pc	1	83024200
	48362-R	9102870	Quadro-V6+	1	Pc	1	83024200
	9194532	9194532	Lengthwise Railing 520 mm, L	1	Pc	1	73269098
	9194533	9194533	Lengthwise Railing 520 mm, R	1	Pc	1	73269098
	9002503	9002503	Railing Connector	2	Pc	2	39269097
	9007355	9007355	Rear panel Connector 144 mm, L	1	Pc	1	83024200
	9007356	9007356	Rear panel Connector 144 mm, R	1	Pc	1	83024200
	9194646	9194646	Cover Cap Grey	2	Pc	2	39269097
	BOM-Code	9249746	Total Set	MRP: 8,130			

	<b>InnoTech Atira - 620 mm (50 Kg) Full Extn. Silent</b>						
	9194402	9194402	Drawer side profile H70 mm, L	1	Pc	1	94039010
	9194403	9194403	Drawer side profile H70 mm, R	1	Pc	1	94039010
	1065191	1065191	Screw-On Front Connector	2	Pc	2	39263000
	40271-L	9126394	Quadro-V6+	1	Pc	1	83024200
	40271-R	9126395	Quadro-V6+	1	Pc	1	83024200
	9194534	9194534	Lengthwise Railing 620 mm, L	1	Pc	1	73269098
	9194535	9194535	Lengthwise Railing 620 mm, R	1	Pc	1	73269098
	9002503	9002503	Railing Connector	2	Pc	2	39269097
	9007355	9007355	Rear panel Connector 144 mm, L	1	Pc	1	83024200
	9007356	9007356	Rear panel Connector 144 mm, R	1	Pc	1	83024200
	9194646	9194646	Cover Cap Grey	2	Pc	2	39269097
	BOM-Code	9249739	Total Set	MRP: 9,004			





## Drawer System: InnoTech Atira

- ▶ Pot & pan drawer with railing, height 176 mm
- ▶ Silver



Product	Article No.	SAP	Item Description	Qty.	Unit	PU	HS Code
	<b>InnoTech Atira - 350 mm (30 Kg) Full Extn. Silent</b>						
	9207690	9207690	Drawer side profile H70 mm, L	1	Pc	1	94039010
	9207696	9207696	Drawer side profile H70 mm, R	1	Pc	1	94039010
	1065191	1065191	Screw-On Front Connector	2	Pc	2	39263000
	45310-L	9126554	Quadro-V6	1	Pc	1	83024200
	45310-R	9126555	Quadro-V6	1	Pc	1	83024200
	9194526	9194526	Lengthwise Railing 350 mm, L	1	Pc	1	73269098
	9194527	9194527	Lengthwise Railing 350 mm, R	1	Pc	1	73269098
	9002503	9002503	Railing Connector	2	Pc	2	39269097
	9027831	9027831	Rear panel Connector 176 mm, L	1	Pc	1	83024200
	9027832	9027832	Rear panel Connector 176 mm, R	1	Pc	1	83024200
	9194646	9194646	Cover Cap Grey	2	Pc	2	39269097
BOM-Code	9349937	Total Set	MRP: 7,811				83021090

	<b>InnoTech Atira - 420 mm (30 Kg) Full Extn. Silent</b>						
	9207697	9207697	Drawer side profile H70 mm, L	1	Pc	1	94039010
	9207699	9207699	Drawer side profile H70 mm, R	1	Pc	1	94039010
	1065191	1065191	Screw-On Front Connector	2	Pc	2	39263000
	45311-L	9126558	Quadro-V6	1	Pc	1	83024200
	45311-R	9126559	Quadro-V6	1	Pc	1	83024200
	9194528	9194528	Lengthwise Railing 420 mm, L	1	Pc	1	73269098
	9194529	9194529	Lengthwise Railing 420 mm, R	1	Pc	1	73269098
	9002503	9002503	Railing Connector	2	Pc	2	39269097
	9027831	9027831	Rear panel Connector 176 mm, L	1	Pc	1	83024200
	9027832	9027832	Rear panel Connector 176 mm, R	1	Pc	1	83024200
	9194646	9194646	Cover Cap Grey	2	Pc	2	39269097
BOM-Code	9349938	Total Set	MRP: 7,847				83021090

	<b>InnoTech Atira - 470 mm (30 Kg) Full Extn. Silent</b>						
	9207700	9207700	Drawer side profile H70 mm, L	1	Pc	1	94039010
	9207702	9207702	Drawer side profile H70 mm, R	1	Pc	1	94039010
	1065191	1065191	Screw-On Front Connector	2	Pc	2	39263000
	45312-L	9126556	Quadro-V6	1	Pc	1	83024200
	45312-R	9126557	Quadro-V6	1	Pc	1	83024200
	9194530	9194530	Lengthwise Railing 470 mm, L	1	Pc	1	73269098
	9194531	9194531	Lengthwise Railing 470 mm, R	1	Pc	1	73269098
	9002503	9002503	Railing Connector	2	Pc	2	39269097
	9027831	9027831	Rear panel Connector 176 mm, L	1	Pc	1	83024200
	9027832	9027832	Rear panel Connector 176 mm, R	1	Pc	1	83024200
	9194646	9194646	Cover Cap Grey	2	Pc	2	39269097
BOM-Code	9349939	Total Set	MRP: 7,427				83021090

## Drawer System: InnoTech Atira

- ▶ Pot & pan drawer with railing, height 176 mm
- ▶ Silver



Product	Article No.	SAP	Item Description	Qty.	Unit	PU	HS Code
	<b>InnoTech Atira - 520 mm (30 Kg) Full Extn. Silent</b>						
	9207703	9207703	Drawer side profile H70 mm, L	1	Pc	1	94039010
	9207704	9207704	Drawer side profile H70 mm, R	1	Pc	1	94039010
	1065191	1065191	Screw-On Front Connector	2	Pc	2	39263000
	45313-L	9126562	Quadro-V6	1	Pc	1	83024200
	45313-R	9126563	Quadro-V6	1	Pc	1	83024200
	9194532	9194532	Lengthwise Railing 520 mm, L	1	Pc	1	73269098
	9194533	9194533	Lengthwise Railing 520 mm, R	1	Pc	1	73269098
	9002503	9002503	Railing Connector	2	Pc	2	39269097
	9027831	9027831	Rear panel Connector 176 mm, L	1	Pc	1	83024200
	9027832	9027832	Rear panel Connector 176 mm, R	1	Pc	1	83024200
	9194646	9194646	Cover Cap Grey	2	Pc	2	39269097
	BOM-Code	9349940	Total Set	MRP: 7,591			

	<b>InnoTech Atira - 420 mm (50 Kg) Full Extn.Silent</b>						
	9207697	9207697	Drawer side profile H70 mm, L	1	Pc	1	94039010
	9207699	9207699	Drawer side profile H70 mm, R	1	Pc	1	94039010
	1065191	1065191	Screw-On Front Connector	2	Pc	2	39263000
	48360-L	9102862	Quadro-V6+	1	Pc	1	83024200
	48360-R	9102864	Quadro-V6+	1	Pc	1	83024200
	9194528	9194528	Lengthwise Railing 420 mm, L	1	Pc	1	73269098
	9194529	9194529	Lengthwise Railing 420 mm, R	1	Pc	1	73269098
	9002503	9002503	Railing Connector	2	Pc	2	39269097
	9027831	9027831	Rear panel Connector 176 mm, L	1	Pc	1	83024200
	9027832	9027832	Rear panel Connector 176 mm, R	1	Pc	1	83024200
	9194646	9194646	Cover Cap Grey	2	Pc	2	39269097
	BOM-Code	9349941	Total Set	MRP: 8,999			

	<b>InnoTech Atira - 470 mm (50 Kg) Full Extn. Silent</b>						
	9207700	9207700	Drawer side profile H70 mm, L	1	Pc	1	94039010
	9207702	9207702	Drawer side profile H70 mm, R	1	Pc	1	94039010
	1065191	1065191	Screw-On Front Connector	2	Pc	2	39263000
	48361-L	9133792	Quadro-V6+	1	Pc	1	83024200
	48361-R	9133793	Quadro-V6+	1	Pc	1	83024200
	9194530	9194530	Lengthwise Railing 470 mm, L	1	Pc	1	73269098
	9194531	9194531	Lengthwise Railing 470 mm, R	1	Pc	1	73269098
	9002503	9002503	Railing Connector	2	Pc	2	39269097
	9027831	9027831	Rear panel Connector 176 mm, L	1	Pc	1	83024200
	9027832	9027832	Rear panel Connector 176 mm, R	1	Pc	1	83024200
	9194646	9194646	Cover Cap Grey	2	Pc	2	39269097
	BOM-Code	9349942	Total Set	MRP: 8,553			

## Drawer System: InnoTech Atira

- ▶ Pot & pan drawer with railing, height 176 mm
- ▶ Silver



Product	Article No.	SAP	Item Description	Qty.	Unit	PU	HS Code
	<b>InnoTech Atira - 520 mm (50 Kg) Full Extn. Silent</b>						
	9207703	9207703	Drawer side profile H70 mm, L	1	Pc	1	94039010
	9207704	9207704	Drawer side profile H70 mm, R	1	Pc	1	94039010
	1065191	1065191	Screw-On Front Connector	2	Pc	2	39263000
	48362-L	9102868	Quadro-V6+	1	Pc	1	83024200
	48362-R	9102870	Quadro-V6+	1	Pc	1	83024200
	9194532	9194532	Lengthwise Railing 520 mm, L	1	Pc	1	73269098
	9194533	9194533	Lengthwise Railing 520 mm, R	1	Pc	1	73269098
	9002503	9002503	Railing Connector	2	Pc	2	39269097
	9027831	9027831	Rear panel Connector 176 mm, L	1	Pc	1	83024200
	9027832	9027832	Rear panel Connector 176 mm, R	1	Pc	1	83024200
	9194646	9194646	Cover Cap Grey	2	Pc	2	39269097
	BOM-Code	9349948	Total Set	MRP: 8,733			

# Drawer System: InnoTech Atira

## ► Internal Accessories



Product	Article No.	SAP	Item Description	Qty.	Unit	PU	MRP	HS Code
<b>Innotech Atira Drawer Side Profile</b>								
	<b>Finish : Silver</b>							
	9207690	9207690	InnoTech Atira- 350 mm-Drawer side profile, L	1	Pc	1	1,078	94039900
	9207696	9207696	InnoTech Atira- 350 mm-Drawer side profile, R	1	Pc	1	1,078	94039900
	9207697	9207697	InnoTech Atira- 420 mm-Drawer side profile, L	1	Pc	1	1,078	94039900
	9207699	9207699	InnoTech Atira- 420 mm-Drawer side profile, R	1	Pc	1	1,078	94039900
	9207700	9207700	InnoTech Atira- 470 mm-Drawer side profile, L	1	Pc	1	999	94039900
	9207702	9207702	InnoTech Atira- 470 mm-Drawer side profile, R	1	Pc	1	999	94039900
	9207703	9207703	InnoTech Atira- 520 mm-Drawer side profile, L	1	Pc	1	999	94039900
	9207704	9207704	InnoTech Atira- 520 mm-Drawer side profile, R	1	Pc	1	999	94039900
	9194402	9194402	InnoTech Atira- 620 mm-Drawer side profile, L	1	Pc	1	1,210	83021090
	9194403	9194403	InnoTech Atira- 620 mm-Drawer side profile, R	1	Pc	1	1,210	83021090
<b>Lengthwise Railing</b>								
	<b>Finish : Silver</b>							
	9194526	9194526	InnoTech Atira- 350 mm-Lengthwise Railing, L	1	Pc	1	447	73269099
	9194527	9194527	InnoTech Atira- 350 mm-Lengthwise Railing, R	1	Pc	1	447	73269099
	9194528	9194528	InnoTech Atira- 420 mm-Lengthwise Railing, L	1	Pc	1	479	73269099
	9194529	9194529	InnoTech Atira- 420 mm-Lengthwise Railing, R	1	Pc	1	479	73269099
	9194530	9194530	InnoTech Atira- 470 mm-Lengthwise Railing, L	1	Pc	1	493	73269099
	9194531	9194531	InnoTech Atira- 470 mm-Lengthwise Railing, R	1	Pc	1	493	73269099
	9194532	9194532	InnoTech Atira- 520 mm-Lengthwise Railing, L	1	Pc	1	493	73269099
	9194533	9194533	InnoTech Atira- 520 mm-Lengthwise Railing, R	1	Pc	1	493	73269099
	9194534	9194534	InnoTech Atira- 620 mm-Lengthwise Railing, L	1	Pc	1	486	73269099
	9194535	9194535	InnoTech Atira- 620 mm-Lengthwise Railing, R	1	Pc	1	486	73269099
	<b>Connector</b>							
	9002503	9002503	Railing Connector	2	Pc	2	44	39269097
	1065191	1065191	Screw-On Front Connector	2	Pc	2	54	39263000
<b>Rear Panel Connector</b>								
	<b>Finish : Silver</b>							
	1062501	1062501	Rear panel Connector 70 mm, L -Silver	1	Pc	1	284	83024200
	1062502	1062502	Rear panel Connector 70 mm, R -Silver	1	Pc	1	284	83024200
	9007355	9007355	Rear panel Connector 144 mm, L -Silver	1	Pc	1	323	83024200
	9007356	9007356	Rear panel Connector 144 mm, R -Silver	1	Pc	1	323	83024200
	9027831	9027831	Rear panel Connector 176 mm, L -Silver	1	Pc	1	669	83024200
	9027832	9027832	Rear panel Connector 176 mm, R -Silver	1	Pc	1	669	83024200
	<b>Cover Cap</b>							
	9194646	9194646	Cover Cap Grey	2	Pc	2	40	39269097

# Drawer System: InnoTech Atira

## ► Internal Accessories



Product	Article No.	SAP	Item Description	Qty.	Unit	PU	MRP	HS Code
	<b>Front Panel with Aluminium (Internal Drawer)</b>							
	9194764	9194764	Aluminium front panel 2000 mm Silver	1	Pc	1	9,840	76109030
	9194614	9194614	Railing for front panel 2000 mm Silver	1	Pc	1	1,710	73269099
	9104107	9104107	Connector for front panel 70 mm Silver	1	Set	30	610	39263090
	9293516	9293516	Connector for front panel 144 mm Silver	1	Pc	1	1,284	39263000
9206256	9206256	Adapter for lengthwise railing Silver	1	Pc	80	410	83024200	

<b>Quadro V6</b>								
	45310-L	9126554	Innotech 350 mm - Quadro-V6	1	Pc	1	1,687	83024200
	45310-R	9126555	Innotech 350 mm - Quadro-V6	1	Pc	1	1,687	83024200
	45311-L	9126558	InnoTech- 420 mm - Quadro-V6	1	Pc	1	1,673	83024200
	45311-R	9126559	InnoTech- 420 mm - Quadro-V6	1	Pc	1	1,673	83024200
	45312-L	9126556	InnoTech- 470 mm - Quadro-V6	1	Pc	1	1,528	83024200
	45312-R	9126557	InnoTech- 470 mm - Quadro-V6	1	Pc	1	1,528	83024200
	45313-L	9126562	InnoTech- 520 mm - Quadro-V6	1	Pc	1	1,610	83024200
	45313-R	9126563	InnoTech- 520 mm - Quadro-V6	1	Pc	1	1,610	83024200





<b>Quadro V6+</b>								
	48360-L	9102862	InnoTech- 420 mm - Quadro-V6+	1	Pc	1	2,249	83024200
	48360-R	9102864	InnoTech- 420 mm - Quadro-V6+	1	Pc	1	2,249	83024200
	48361-L	9133792	InnoTech- 470 mm - Quadro-V6+	1	Pc	1	2,091	83024200
	48361-R	9133793	InnoTech- 470 mm - Quadro-V6+	1	Pc	1	2,091	83024200
	48362-L	9102868	InnoTech- 520 mm - Quadro-V6+	1	Pc	1	2,181	83024200
	48362-R	9102870	InnoTech- 520 mm - Quadro-V6+	1	Pc	1	2,181	83024200
	40271-L	9126394	InnoTech- 620 mm - Quadro-V6+	1	Pc	1	2,414	83024200
	40271-R	9126395	InnoTech- 620 mm - Quadro-V6+	1	Pc	1	2,414	83024200



# Drawer System: InnoTech

- ▶ Drawer height 70 mm
- ▶ Silver







Product	Article No.	SAP	Item Description	Qty.	Unit	PU	HS Code
	<b>InnoTech- 350 mm (30 Kg) Full Extn. Silent</b>						
	1062015	9019693	Drawer side profile, L	1	Pc	1	94039010
	1062016	9019694	Drawer side profile, R	1	Pc	1	94039010
	1065191	1065191	Screw-On Front Connector	2	Pc	2	39263000
	45310-L	9126554	Quadro-V6	1	Pc	1	83024200
	45310-R	9126555	Quadro-V6	1	Pc	1	83024200
	1062501	1062501	Rear panel Connector, L	1	Pc	1	83024200
	1062502	1062502	Rear panel Connector, R	1	Pc	1	83024200
	9194646	9194646	Cover Cap Grey	2	Pc	2	39269097
BOM-Code	9243083	Total Set	MRP: 6,170				83021090
	<b>InnoTech- 420 mm (30 Kg) Full Extn. Silent</b>						
	1062017	9015786	Drawer side profile, L	1	Pc	1	94039010
	1062018	9015787	Drawer side profile, R	1	Pc	1	94039010
	1065191	1065191	Screw-On Front Connector	2	Pc	2	39263000
	45311-L	9126558	Quadro-V6	1	Pc	1	83024200
	45311-R	9126559	Quadro-V6	1	Pc	1	83024200
	1062501	1062501	Rear panel Connector, L	1	Pc	1	83024200
	1062502	1062502	Rear panel Connector, R	1	Pc	1	83024200
	9194646	9194646	Cover Cap Hettich logo Grey Background	2	Pc	2	39269097
BOM-Code	9243084	Total Set	MRP: 6,164				83021090
	<b>InnoTech- 470 mm (30 Kg) Full Extn. Silent</b>						
	1062019	9015793	Drawer side profile, L	1	Pc	1	94039010
	1062020	9015794	Drawer side profile, R	1	Pc	1	94039010
	1065191	1065191	Screw-On Front Connector	2	Pc	2	39263000
	45312-L	9126556	Quadro-V6	1	Pc	1	83024200
	45312-R	9126557	Quadro-V6	1	Pc	1	83024200
	1062501	1062501	Rear panel Connector, L	1	Pc	1	83024200
	1062502	1062502	Rear panel Connector, R	1	Pc	1	83024200
	9194646	9194646	Cover Cap Grey	2	Pc	2	39269097
BOM-Code	9243085	Total Set	MRP: 5,622				83021090
	<b>InnoTech- 520 mm (30 Kg) Full Extn. Silent</b>						
	1062521	9015811	Drawer side profile, L	1	Pc	1	94039010
	1062522	9015812	Drawer side profile, R	1	Pc	1	94039010
	1065191	1065191	Screw-On Front Connector	2	Pc	2	39263000
	45313-L	9126562	Quadro-V6	1	Pc	1	83024200
	45313-R	9126563	Quadro-V6	1	Pc	1	83024200
	1062501	1062501	Rear panel Connector, L	1	Pc	1	83024200
	1062502	1062502	Rear panel Connector, R	1	Pc	1	83024200
	9194646	9194646	Cover Cap Grey	2	Pc	2	39269097
BOM-Code	9243086	Total Set	MRP: 5,876				83021090

## Drawer System: InnoTech

- ▶ Drawer height 70 mm
- ▶ Silver







Product	Article No.	SAP	Item Description	Qty.	Unit	PU	HS Code
	<b>InnoTech- 420 mm (50 Kg) Full Extn. Silent</b>						
	1062017	9015786	Drawer side profile, L	1	Pc	1	94039010
	1062018	9015787	Drawer side profile, R	1	Pc	1	94039010
	1065191	1065191	Screw-On Front Connector	2	Pc	2	39263000
	48360-L	9102862	Quadro-V6+	1	Pc	1	83024200
	48360-R	9102864	Quadro-V6+	1	Pc	1	83024200
	1062501	1062501	Rear panel Connector, L	1	Pc	1	83024200
	1062502	1062502	Rear panel Connector, R	1	Pc	1	83024200
	9194646	9194646	Cover Cap Grey	2	Pc	2	39269097
BOM-Code	9243087	Total Set	MRP: 7,316				83021090
	<b>InnoTech- 470 mm (50 Kg) Full Extn. Silent</b>						
	1062019	9015793	Drawer side profile, L	1	Pc	1	94039010
	1062020	9015794	Drawer side profile, R	1	Pc	1	94039010
	1065191	1065191	Screw-On Front Connector	2	Pc	2	39263000
	48361-L	9133792	Quadro-V6+	1	Pc	1	83024200
	48361-R	9133793	Quadro-V6+	1	Pc	1	83024200
	1062501	1062501	Rear panel Connector, L	1	Pc	1	83024200
	1062502	1062502	Rear panel Connector, R	1	Pc	1	83024200
	9194646	9194646	Cover Cap Grey	2	Pc	2	39269097
BOM-Code	9243088	Total Set	MRP: 6,748				83024200
	<b>InnoTech- 520 mm (50 Kg) Full Extn. Silent</b>						
	1062521	9015811	Drawer side profile, L	1	Pc	1	94039010
	1062522	9015812	Drawer side profile, R	1	Pc	1	94039010
	1065191	1065191	Screw-On Front Connector	2	Pc	2	39263000
	48362-L	9102868	Quadro-V6+	1	Pc	1	83024200
	48362-R	9102870	Quadro-V6+	1	Pc	1	83024200
	1062501	1062501	Rear panel Connector, L	1	Pc	1	83024200
	1062502	1062502	Rear panel Connector, R	1	Pc	1	83024200
	9194646	9194646	Cover Cap Grey	2	Pc	2	39269097
BOM-Code	9243089	Total Set	MRP: 7,018				83021090
	<b>InnoTech- 620 mm (50 Kg) Full Extn. Silent</b>						
	1077781	1077781	Drawer side profile, L	1	Pc	1	94039010
	1077782	1077782	Drawer side profile, R	1	Pc	1	94039010
	1065191	1065191	Screw-On Front Connector	2	Pc	2	39263000
	40271-L	9126394	Quadro-V6+	1	Pc	1	83024200
	40271-R	9126395	Quadro-V6+	1	Pc	1	83024200
	1062501	1062501	Rear panel Connector, L	1	Pc	1	83024200
	1062502	1062502	Rear panel Connector, R	1	Pc	1	83024200
	9194646	9194646	Cover Cap Grey	2	Pc	2	39269097
BOM-Code	9243090	Total Set	MRP: 7,890				83021090

## Drawer System: InnoTech

- ▶ Pot & pan drawer with railing, height 144 mm
- ▶ Silver







Product	Article No.	SAP	Item Description	Qty.	Unit	PU	HS Code
	<b>InnoTech- 350 mm (30 Kg) Full Extn. Silent</b>						
	1062015	9019693	Drawer side profile H70 mm, L	1	Pc	1	94039010
	1062016	9019694	Drawer side profile H70 mm, R	1	Pc	1	94039010
	1065191	1065191	Screw-On Front Connector	2	Pc	2	39263000
	45310-L	9126554	Quadro-V6	1	Pc	1	83024200
	45310-R	9126555	Quadro-V6	1	Pc	1	83024200
	1070630	1070630	Longitudinal Railing	2	Pc	2	73269098
	9002503	9002503	Railing Connector	2	Pc	2	39269097
	9007355	9007355	Rear panel Connector 144 mm, L	1	Pc	1	83024200
	9007356	9007356	Rear panel Connector 144 mm, R	1	Pc	1	83024200
	9194646	9194646	Cover Cap Grey	2	Pc	2	39269097
BOM-Code	9243091	Total Set	MRP: 7,016				83021090
	<b>InnoTech- 420 mm (30 Kg) Full Extn. Silent</b>						
	1062017	9015786	Drawer side profile H70 mm, L	1	Pc	1	94039010
	1062018	9015787	Drawer side profile H70 mm, R	1	Pc	1	94039010
	1065191	1065191	Screw-On Front Connector	2	Pc	2	39263000
	45311-L	9126558	Quadro-V6	1	Pc	1	83024200
	45311-R	9126559	Quadro-V6	1	Pc	1	83024200
	1063675	1063675	Longitudinal Railing	2	Pc	2	73269098
	9002503	9002503	Railing Connector	2	Pc	2	39269097
	9007355	9007355	Rear panel Connector 144 mm, L	1	Pc	1	83024200
	9007356	9007356	Rear panel Connector 144 mm, R	1	Pc	1	83024200
	9194646	9194646	Cover Cap Grey	2	Pc	2	39269097
BOM-Code	9243092	Total Set	MRP: 7,010				83021090
	<b>InnoTech- 470 mm (30 Kg) Full Extn. Silent</b>						
	1062019	9015793	Drawer side profile H70 mm, L	1	Pc	1	94039010
	1062020	9015794	Drawer side profile H70 mm, R	1	Pc	1	94039010
	1065191	1065191	Screw-On Front Connector	2	Pc	2	39263000
	45312-L	9126556	Quadro-V6	1	Pc	1	83024200
	45312-R	9126557	Quadro-V6	1	Pc	1	83024200
	1062394	1062394	Longitudinal Railing	2	Pc	2	83024200
	9002503	9002503	Railing Connector	2	Pc	2	39269097
	9007355	9007355	Rear panel Connector 144 mm, L	1	Pc	1	83024200
	9007356	9007356	Rear panel Connector 144 mm, R	1	Pc	1	83024200
	9194646	9194646	Cover Cap Grey	2	Pc	2	39269097
BOM-Code	9243093	Total Set	MRP: 6,468				83021090
	<b>InnoTech- 520 mm (30 Kg) Full Extn. Silent</b>						
	1062521	9015811	Drawer side profile H70 mm, L	1	Pc	1	94039010
	1062522	9015812	Drawer side profile H70 mm, R	1	Pc	1	94039010
	1065191	1065191	Screw-On Front Connector	2	Pc	2	39263000
	45313-L	9126562	Quadro-V6	1	Pc	1	83024200
	45313-R	9126563	Quadro-V6	1	Pc	1	83024200
	1063677	1063677	Longitudinal Railing	2	Pc	2	73269098
	9002503	9002503	Railing Connector	2	Pc	2	39269097
	9007355	9007355	Rear panel Connector 144 mm, L	1	Pc	1	83024200
	9007356	9007356	Rear panel Connector 144 mm, R	1	Pc	1	83024200
	9194646	9194646	Cover Cap Grey	2	Pc	2	39269097
BOM-Code	9243094	Total Set	MRP: 6,734				83021090

## Drawer System: InnoTech

- ▶ Pot & pan drawer with railing, height 144 mm
- ▶ Silver



Product	Article No.	SAP	Item Description	Qty.	Unit	PU	HS Code
	<b>InnoTech- 420 mm (50 Kg) Full Extn.Silent</b>						
	1062017	9015786	Drawer side profile H70 mm, L	1	Pc	1	94039010
	1062018	9015787	Drawer side profile H70 mm, R	1	Pc	1	94039010
	1065191	1065191	Screw-On Front Connector	2	Pc	2	39263000
	48360-L	9102862	Quadro-V6+	1	Pc	1	83024200
	48360-R	9102864	Quadro-V6+	1	Pc	1	83024200
	1063675	1063675	Longitudinal Railing	2	Pc	2	73269098
	9002503	9002503	Railing Connector	2	Pc	2	39269097
	9007355	9007355	Rear panel Connector 144 mm, L	1	Pc	1	83024200
	9007356	9007356	Rear panel Connector 144 mm, R	1	Pc	1	83024200
	9194646	9194646	Cover Cap Grey	2	Pc	2	39269097
BOM-Code	9243095	Total Set	MRP:8,162				83021090
	<b>InnoTech- 470 mm (50 Kg) Full Extn. Silent</b>						
	1062019	9015793	Drawer side profile H70 mm, L	1	Pc	1	94039010
	1062020	9015794	Drawer side profile H70 mm, R	1	Pc	1	94039010
	1065191	1065191	Screw-On Front Connector	2	Pc	2	39263000
	48361-L	9133792	Quadro-V6+	1	Pc	1	83024200
	48361-R	9133793	Quadro-V6+	1	Pc	1	83024200
	1062394	1062394	Longitudinal Railing	2	Pc	2	73269098
	9002503	9002503	Railing Connector	2	Pc	2	39269097
	9007355	9007355	Rear panel Connector 144 mm, L	1	Pc	1	83024200
	9007356	9007356	Rear panel Connector 144 mm, R	1	Pc	1	83024200
	9194646	9194646	Cover Cap Grey	2	Pc	2	39269097
BOM-Code	9243096	Total Set	MRP: 7,594				83021090
	<b>InnoTech- 520 mm (50 Kg) Full Extn. Silent</b>						
	1062521	9015811	Drawer side profile H70 mm, L	1	Pc	1	94039010
	1062522	9015812	Drawer side profile H70 mm, R	1	Pc	1	94039010
	1065191	1065191	Screw-On Front Connector	2	Pc	2	39263000
	48362-L	9102868	Quadro-V6+	1	Pc	1	83024200
	48362-R	9102870	Quadro-V6+	1	Pc	1	83024200
	1063677	1063677	Longitudinal Railing	2	Pc	2	73269098
	9002503	9002503	Railing Connector	2	Pc	2	39269097
	9007355	9007355	Rear panel Connector 144 mm, L	1	Pc	1	83024200
	9007356	9007356	Rear panel Connector 144 mm, R	1	Pc	1	83024200
	9194646	9194646	Cover Cap Grey	2	Pc	2	39269097
BOM-Code	9243097	Total Set	MRP:7,876				83021090
	<b>InnoTech- 620 mm (50 Kg) Full Extn. Silent</b>						
	1077781	1077781	Drawer side profile H70 mm, L	1	Pc	1	94039010
	1077782	1077782	Drawer side profile H70 mm, R	1	Pc	1	94039010
	1065191	1065191	Screw-On Front Connector	2	Pc	2	39263000
	40271-L	9126394	Quadro-V6+	1	Pc	1	83024200
	40271-R	9126395	Quadro-V6+	1	Pc	1	83024200
	1077931	1077931	Longitudinal Railing	2	Pc	2	73269098
	9002503	9002503	Railing Connector	2	Pc	2	39269097
	9007355	9007355	Rear panel Connector 144 mm, L	1	Pc	1	83024200
	9007356	9007356	Rear panel Connector 144 mm, R	1	Pc	1	83024200
	9194646	9194646	Cover Cap Grey	2	Pc	2	39269097
BOM-Code	9243098	Total Set	MRP: 8,736				83021090

## Drawer System: InnoTech

- ▶ Pot & pan drawer with railing, height 176 mm
- ▶ Silver



Product	Article No.	SAP	Item Description	Qty.	Unit	PU	HS Code
	<b>InnoTech- 350 mm (30 Kg) Full Extn. Silent</b>						
	1062015	9019693	Drawer side profile H70 mm, L	1	Pc	1	94039010
	1062016	9019694	Drawer side profile H70 mm, R	1	Pc	1	94039010
	1065191	1065191	Screw-On Front Connector	2	Pc	2	39263000
	45310-L	9126554	Quadro-V6	1	Pc	1	83024200
	45310-R	9126555	Quadro-V6	1	Pc	1	83024200
	1070630	1070630	Longitudinal Railing	2	Pc	2	73269098
	9002503	9002503	Railing Connector	2	Pc	2	39269097
	9027831	9027831	Rear panel Connector 176 mm, L	1	Pc	1	83024200
	9027832	9027832	Rear panel Connector 176 mm, R	1	Pc	1	83024200
	9194646	9194646	Cover Cap Grey	2	Pc	2	39269097
BOM-Code	9346352	Total Set	MRP: 7,708				83021090
	<b>InnoTech- 420 mm (30 Kg) Full Extn. Silent</b>						
	1062017	9015786	Drawer side profile H70 mm, L	1	Pc	1	94039010
	1062018	9015787	Drawer side profile H70 mm, R	1	Pc	1	94039010
	1065191	1065191	Screw-On Front Connector	2	Pc	2	39263000
	45311-L	9126558	Quadro-V6	1	Pc	1	83024200
	45311-R	9126559	Quadro-V6	1	Pc	1	83024200
	1063675	1063675	Longitudinal Railing	2	Pc	2	73269098
	9002503	9002503	Railing Connector	2	Pc	2	39269097
	9027831	9027831	Rear panel Connector 176 mm, L	1	Pc	1	83024200
	9027832	9027832	Rear panel Connector 176 mm, R	1	Pc	1	83024200
	9194646	9194646	Cover Cap Grey	2	Pc	2	39269097
BOM-Code	9346353	Total Set	MRP: 7,702				83021090
	<b>InnoTech- 470 mm (30 Kg) Full Extn. Silent</b>						
	1062019	9015793	Drawer side profile H70 mm, L	1	Pc	1	94039010
	1062020	9015794	Drawer side profile H70 mm, R	1	Pc	1	94039010
	1065191	1065191	Screw-On Front Connector	2	Pc	2	39263000
	45312-L	9126556	Quadro-V6	1	Pc	1	83024200
	45312-R	9126557	Quadro-V6	1	Pc	1	83024200
	1062394	1062394	Longitudinal Railing	2	Pc	2	83024200
	9002503	9002503	Railing Connector	2	Pc	2	39269097
	9027831	9027831	Rear panel Connector 176 mm, L	1	Pc	1	83024200
	9027832	9027832	Rear panel Connector 176 mm, R	1	Pc	1	83024200
	9194646	9194646	Cover Cap Grey	2	Pc	2	39269097
BOM-Code	9346354	Total Set	MRP: 7,160				83021090
	<b>InnoTech- 520 mm (30 Kg) Full Extn. Silent</b>						
	1062521	9015811	Drawer side profile H70 mm, L	1	Pc	1	94039010
	1062522	9015812	Drawer side profile H70 mm, R	1	Pc	1	94039010
	1065191	1065191	Screw-On Front Connector	2	Pc	2	39263000
	45313-L	9126562	Quadro-V6	1	Pc	1	83024200
	45313-R	9126563	Quadro-V6	1	Pc	1	83024200
	1063677	1063677	Longitudinal Railing	2	Pc	2	73269098
	9002503	9002503	Railing Connector	2	Pc	2	39269097
	9027831	9027831	Rear panel Connector 176 mm, L	1	Pc	1	83024200
	9027832	9027832	Rear panel Connector 176 mm, R	1	Pc	1	83024200
	9194646	9194646	Cover Cap Grey	2	Pc	2	39269097
BOM-Code	9346355	Total Set	MRP: 7,426				83021090



## Drawer System: InnoTech

- ▶ Pot & pan drawer with railing, height 176 mm
- ▶ Silver



Product	Article No.	SAP	Item Description	Qty.	Unit	PU	HS Code
	<b>InnoTech- 420 mm (50 Kg) Full Extn.Silent</b>						
	1062017	9015786	Drawer side profile H70 mm, L	1	Pc	1	94039010
	1062018	9015787	Drawer side profile H70 mm, R	1	Pc	1	94039010
	1065191	1065191	Screw-On Front Connector	2	Pc	2	39263000
	48360-L	9102862	Quadro-V6+	1	Pc	1	83024200
	48360-R	9102864	Quadro-V6+	1	Pc	1	83024200
	1063675	1063675	Longitudinal Railing	2	Pc	2	73269098
	9002503	9002503	Railing Connector	2	Pc	2	39269097
	9027831	9027831	Rear panel Connector 176 mm, L	1	Pc	1	83024200
	9027832	9027832	Rear panel Connector 176 mm, R	1	Pc	1	83024200
	9194646	9194646	Cover Cap Grey	2	Pc	2	39269097
BOM-Code	9346356	Total Set	MRP: 8,854				83021090
	<b>InnoTech- 470 mm (50 Kg) Full Extn. Silent</b>						
	1062019	9015793	Drawer side profile H70 mm, L	1	Pc	1	94039010
	1062020	9015794	Drawer side profile H70 mm, R	1	Pc	1	94039010
	1065191	1065191	Screw-On Front Connector	2	Pc	2	39263000
	48361-L	9133792	Quadro-V6+	1	Pc	1	83024200
	48361-R	9133793	Quadro-V6+	1	Pc	1	83024200
	1062394	1062394	Longitudinal Railing	2	Pc	2	83024200
	9002503	9002503	Railing Connector	2	Pc	2	39269097
	9027831	9027831	Rear panel Connector 176 mm, L	1	Pc	1	83024200
	9027832	9027832	Rear panel Connector 176 mm, R	1	Pc	1	83024200
	9194646	9194646	Cover Cap Grey	2	Pc	2	39269097
BOM-Code	9346357	Total Set	MRP: 8,286				83021090
	<b>InnoTech- 520 mm (50 Kg) Full Extn. Silent</b>						
	1062521	9015811	Drawer side profile H70 mm, L	1	Pc	1	94039010
	1062522	9015812	Drawer side profile H70 mm, R	1	Pc	1	94039010
	1065191	1065191	Screw-On Front Connector	2	Pc	2	39263000
	48362-L	9102868	Quadro-V6+	1	Pc	1	83024200
	48362-R	9102870	Quadro-V6+	1	Pc	1	83024200
	1063677	1063677	Longitudinal Railing	2	Pc	2	73269098
	9002503	9002503	Railing Connector	2	Pc	2	39269097
	9027831	9027831	Rear panel Connector 176 mm, L	1	Pc	1	83024200
	9027832	9027832	Rear panel Connector 176 mm, R	1	Pc	1	83024200
	9194646	9194646	Cover Cap Grey	2	Pc	2	39269097
BOM-Code	9346358	Total Set	MRP: 8,568				83021090
	<b>InnoTech- 620 mm (50 Kg) Full Extn. Silent</b>						
	1077781	1077781	Drawer side profile H70 mm, L	1	Pc	1	94039010
	1077782	1077782	Drawer side profile H70 mm, R	1	Pc	1	94039010
	1065191	1065191	Screw-On Front Connector	2	Pc	2	39263000
	40271-L	9126394	Quadro-V6+	1	Pc	1	83024200
	40271-R	9126395	Quadro-V6+	1	Pc	1	83024200
	1077931	1077931	Longitudinal Railing	2	Pc	2	73269098
	9002503	9002503	Railing Connector	2	Pc	2	39269097
	9027831	9027831	Rear panel Connector 176 mm, L	1	Pc	1	83024200
	9027832	9027832	Rear panel Connector 176 mm, R	1	Pc	1	83024200
	9194646	9194646	Cover Cap Grey	2	Pc	2	39269097
BOM-Code	9346359	Total Set	MRP: 9,428				83021090

## Drawer System: InnoTech

- ▶ Internal drawer 70 mm & 144 mm, 30 Kg, Drawer, height 70 / 144 mm
- ▶ Silver



Product	Article No.	SAP	Item Description	Qty.	Unit	PU	MRP	HS Code
<b>Internal InnoTech 100- 470 mm (30 Kg) Full Extn. Silent. Alu Front</b>								
	1062019	9015793	Drawer side profile, L	1	Pc	1	952	94039010
	1062020	9015794	Drawer side profile, R	1	Pc	1	952	94039010
	45312-L	9126556	Quadro-V6	1	Pc	1	1,528	83024200
	45312-R	9126557	Quadro-V6	1	Pc	1	1,528	83024200
	1062501	1062501	Rear panel Connector, L	1	Pc	1	284	83024200
	1062502	1062502	Rear panel Connector, R	1	Pc	1	284	83024200
	9194646	9194646	Cover Cap Grey	2	Pc	2	40	39269097
	9104108	9104108	Aluminium front 2000 mm	1	Pc	1	7,832	76041090
	9104107	9104107	Connector for aluminium front	1	Set	1	610	39269097

<b>Internal Pot &amp; Pan InnoTech 100- 470 mm (30 Kg) Full Extn. Silent. Aluminium Front</b>								
	1062019	9015793	Drawer side profile, L	1	Pc	1	952	94039010
	1062020	9015794	Drawer side profile, R	1	Pc	1	952	94039010
	45312-L	9126556	Quadro-V6	1	Set	1	1,528	83024200
	45312-R	9126557	Quadro-V6	1	Set	1	1,528	83024200
	9194646	9194646	Cover Cap Grey	2	Pc	2	40	39269097
	9086205	9086205	Aluminum Pot and Pan Front 600 mm 144 H	1	Pc	20	4,355	94039010
	1062394	1062394	Innotech Gallery, 470 mm (Silver)	2	Pc	2	724	83024200
	9007355	9007355	Rear panel Connector 144 mm, L	1	Pc	1	323	83024200
	9007356	9007356	Rear panel Connector 144 mm, R	1	Pc	1	323	83024200
	9104108	9104108	Aluminium front 2000 mm	1	Pc	1	7,832	76041090
	1074009	1074009	Railing for aluminium front	1	Pc	1	1,144	73063011
	9104118	9104118	Corner Connector H144 mm, Set Both L & R	1	Set	1	1,153	39269097

Product	Article No.	SAP	Item Description	Qty.	Unit	PU	HS Code
<b>InnoTech Silver- 470 mm (30 Kg) Part Extn. Silent EB 9.5</b>							
	1062019	9015793	Drawer side profile, L	1	Pc	1	94039010
	1062020	9015794	Drawer side profile, R	1	Pc	1	94039010
	1065191	1065191	Screw-On Front Connector	2	Pc	2	39263000
	9158991	9158991	Quadro 25 - L	1	Pc	1	83024200
	9158993	9158993	Quadro 25 - R	1	Pc	1	83024200
	1062501	1062501	Rear panel Connector, L	1	Pc	1	83024200
	1062502	1062502	Rear panel Connector, R	1	Pc	1	83024200
	9194646	9194646	Cover Cap Grey	2	Pc	2	39269097
BOM-Code	9321557	Total Set	MRP: 4,594				83021090

<b>InnoTech Silver, Pot &amp; Pan- 470 mm (30 Kg) Part Extn. Silent EB 9.5</b>							
	1062019	9015793	Drawer side profile, L	1	Pc	1	94039010
	1062020	9015794	Drawer side profile, R	1	Pc	1	94039010
	1065191	1065191	Screw-On Front Connector	2	Pc	2	39263000
	9158991	9158991	Quadro 25 - L	1	Pc	1	83024200
	9158993	9158993	Quadro 25 - R	1	Pc	1	83024200
	1062394	1062394	Longitudinal Railing	2	Pc	2	83024200
	9002503	9002503	Railing Connector	2	Pc	2	39269097
	9007355	9007355	Rear panel Connector 144mm, L	1	Pc	1	83024200
	9007356	9007356	Rear panel Connector 144mm, R	1	Pc	1	83024200
	9194646	9194646	Cover Cap Grey	2	Pc	2	39269097
BOM-Code	9321558	Total Set	MRP: 5,440				83021090

# Drawer System: InnoTech

► Accessories



Product	Article No.	SAP	Item Description	Qty.	Unit	PU	HS Code
	<b>InnoTech Silver, Pot &amp; Pan- 470 mm (30 Kg) Part Extn. Silent</b>						
	1062019	9015793	Drawer side profile, L	1	Pc	1	94039010
	1062020	9015794	Drawer side profile, R	1	Pc	1	94039010
	1065191	1065191	Screw-On Front Connector	2	Pc	2	39263000
	9158991	9158991	Quadro 25 - L	1	Pc	1	83024200
	9158993	9158993	Quadro 25 - R	1	Pc	1	83024200
	1062394	1062394	Longitudinal Railing	2	Pc	2	83024200
	9002503	9002503	Railing Connector	2	Pc	2	39269097
	9027831	9027831	Rear panel Connector 176 mm, L	1	Pc	1	83024200
	9027832	9027832	Rear panel Connector 176 mm, R	1	Pc	1	83024200
	9194646	9194646	Cover Cap Grey	2	Pc	2	39269097
BOM-Code	9346360	Total Set	MRP: 5,970				83021090

Product	Article No.	SAP	Item Description	Qty.	Unit	PU	MRP	HS Code
	<b>InnoTech TopSide</b>							
	9004315	9004315	H144/470 Silver	1	Set	1	1,820	94039010
	9005411	9005411	H144/520 Silver	1	Set	1	1,630	83024200
	9079648	9079648	Universal Adapter Topside H144 Grey	1	Set	1	950	94039010

Product	Article No.	SAP	Item Description	Qty.	Unit	PU	MRP	HS Code
	<b>InnoTech DesignSide</b>							
	9100889	9100889	Grey, Float Glass+Adapters 470 mm	1	Set	1	3,483	70200080
	9100890	9100890	Grey, Float Glass+Adapters 520 mm	1	Set	1	4,080	94039000
	9100878	9100878	Innotech Adapter for DesignSide	1	Set	1	2,080	70200080

## Anti-slip mat for InnoTech

Product	Article No.	SAP	Item Description	Qty.	Unit	PU	MRP	HS Code
	<b>Anti-slip mat - Classic (5 m roll)</b>							
	9209533	9209533	Anti-slip Mat 470 Silver	1	Pc	1	7,041	39269097
	9209536	9209536	Anti-slip Mat 520 Silver	1	Pc	1	7,170	39269097
	9209568	9209568	Anti-slip Mat 620 Silver	1	Pc	1	9,714	39269097
	9209580	9209580	Anti-slip Mat 500 Anthracite	1	Pc	1	7,111	39269097
	<b>Anti-slip mat - Hard Chequered (5 m roll)</b>							
	9290039	9290039	Anti slip mat W5000 D470 Silver	1	Pc	1	2,090	39181090
	9290040	9290040	Anti slip mat W5000 D520 Silver	1	Pc	1	2,290	39181090
	9290051	9290051	Anti slip mat W5000 D470 Anthracite	1	Pc	1	2,090	39181090
	9290052	9290052	Anti slip mat W5000 D520 Anthracite	1	Pc	1	2,290	39181090

# Drawer System: InnoTech

## ► Internal Accessories







Product	Article No.	SAP	Item Description	Qty.	Unit	PU	MRP	HS Code
	<b>OrgaTray 440 Trimmable (Fixed Partition Cutlery) – Silver</b>							
	9194924	9194924	Tray width 501-600 mm, Depth 370 - 440 mm	1	Pc	1	800	39249000
	9194933	9194933	Tray width 301-350 mm, depth 441 - 520 mm	1	Pc	1	580	39249090
	9194934	9194934	Tray width 351-400 mm, Depth 441- 520 mm	1	Pc	1	600	39249000
	9194935	9194935	Tray width 401-450 mm, Depth 441- 520 mm	1	Pc	1	630	39249000
	9194936	9194936	Tray width 451-500 mm, Depth 441- 520 mm	1	Pc	1	700	39249000
	9194937	9194937	Tray width 501-600 mm, Depth 441- 520 mm	1	Pc	1	830	39249000
	9194938	9194938	Tray width 601-700 mm, Depth 441- 520 mm	1	Pc	1	1,450	39249000
	9194939	9194939	Tray width 701-800 mm, Depth 441- 520 mm	1	Pc	1	1,590	39249000
9194940	9194940	Tray width 801-900 mm, Depth 441- 520 mm	1	Pc	1	1,670	39249000	
	<b>OrgaTray 440 Trimmable (Fixed Partition Cutlery) – Anthracite</b>							
	9194995	9194995	Tray width 301-350 mm, depth 441-520 mm	1	Pc	1	580	39249000
	9194996	9194996	Tray width 351-400 mm, depth 441-520 mm	1	Pc	1	600	39249090
	9194997	9194997	Tray width 401-450 mm, depth 441-520 mm	1	Pc	1	630	39249000
	9194998	9194998	Tray width 451-500 mm, depth 441-520 mm	1	Pc	1	700	39249000
	9194999	9194999	Tray width 501-600 mm, depth 441-520 mm	1	Pc	1	830	39249000
	9195000	9195000	Tray width 601-700 mm, depth 441- 520 mm	1	Pc	1	1,450	39249000
	9195001	9195001	Tray width 701-800 mm, depth 441-520 mm	1	Pc	1	1,590	39249000
	9195002	9195002	Tray width 801-900 mm, depth 441-520 mm	1	Pc	1	1,670	39249000
9195004	9195004	Tray width 1091-1150 mm, depth 441-520 mm	1	Pc	1	2,355	39249000	
	<b>Knife Holder &amp; Spice Rack</b>							
	9226100	9226100	Knife Holder	1	Pc	1	3,320	94039900
	9079207	9079207	Spice Rack	1	Pc	1	4,680	44199090
	<b>OrgaTray 560 (Adjustable Partition Cutlery)</b>							
	13306	9002441	For 470 mm depth, cab width 600 mm	1	Set	1	2,790	39249000
	13307	9005806	For 470 mm depth, cab width 800 mm	1	Set	1	5,310	39249000
	13308	9004427	For 470 mm depth, cab width 900 mm	1	Set	1	5,380	39249000
	13317	9005651	For 520 mm depth, cab width 600 mm	1	Set	1	2,930	39249000
13319	9005671	For 520 mm depth, cab width 900 mm	1	Set	1	5,840	39249000	
	<b>OrgaTray 590 (Adjustable Partition Cutlery)</b>							
	9194891	9194891	For 470 mm depth, cab width 600 mm	1	Set	1	2,340	39249000
9194893	9194893	For 470 mm depth, cab width 900 mm	1	Set	1	4,520	39249000	
	<b>OrgaTray 630 (Powder Coated Steel Cutlery)</b>							
9288441	9288441	For 470 mm depth, for cab width 400 mm & above	1	Set	1	5,495	73239900	

# Drawer System: InnoTech

## ► Internal Accessories



Product	Article No.	SAP	Item Description	Qty.	Unit	PU	MRP	HS Code
	<b>Lengthwise railing for wooden rear panel (Add on kit)</b>							
	1081333	1081333	470 mm	1	Set	8	589	73269098
	1081335	1081335	520 mm	1	Set	8	707	73269098
	1081337	1081337	620 mm	1	Set	1	1,230	73269098
	9002503	9002503	Front connector with Expanding socket	2	Pc	2	44	39269097
	<b>Crosswise railing for Pot &amp; Pan drawer</b>							
	10016	10016	Double railing kit 470 mm	1	Set	1	2,690	73269098
	10017	10017	Double railing kit 520 mm	1	Set	1	3,015	94039010
	77924	1074009	Crosswise railing 1100 mm Silver	1	Pc	1	1,144	73063011
	77925	1070632	Mount for crosswise railing	1	Pc	20	36	39263000
	9014651	9014651	IT Orgastore flag gray	1	Pc	20	390	39269097
<b>Innotech Drawer Side Profile</b>								
	<b>Finish : Silver</b>							
	1062015	9019693	InnoTech- 350 mm-Drawer side profile, L -Silver	1	Pc	1	1,067	94039010
	1062016	9019694	InnoTech- 350 mm-Drawer side profile, R -Silver	1	Pc	1	1,067	94039010
	1062017	9015786	InnoTech- 420 mm-Drawer side profile, L -Silver	1	Pc	1	1,078	94039010
	1062018	9015787	InnoTech- 420 mm-Drawer side profile, R -Silver	1	Pc	1	1,078	94039010
	1062019	9015793	InnoTech- 470 mm-Drawer side profile, L -Silver	1	Pc	1	952	94039010
	1062020	9015794	InnoTech- 470 mm-Drawer side profile, R -Silver	1	Pc	1	952	94039010
	1062521	9015811	InnoTech- 520 mm-Drawer side profile, L -Silver	1	Pc	1	997	94039010
	1062522	9015812	InnoTech- 520 mm-Drawer side profile, R -Silver	1	Pc	1	997	94039010
	1077781	1077781	InnoTech- 620 mm-Drawer side profile, L -Silver	1	Pc	1	1,200	94039010
1077782	1077782	InnoTech- 620 mm-Drawer side profile, R -Silver	1	Pc	1	1,200	94039010	
<b>Longitudinal railing</b>								
	<b>Finish : Silver</b>							
	1070630	1070630	InnoTech- 350 mm-Longitudinal Railing -Silver	1	Pc	1	362	73269098
	1063675	1063675	InnoTech- 420 mm-Longitudinal Railing -Silver	1	Pc	1	362	73269098
	1062394	1062394	InnoTech- 470 mm-Longitudinal Railing -Silver	1	Pc	1	362	83024200
	1063677	1063677	InnoTech- 520 mm-Longitudinal Railing -Silver	1	Pc	1	368	73269098
	1077931	1077931	InnoTech- 620 mm-Longitudinal Railing -Silver	1	Pc	1	362	73269098
	<b>Connector</b>							
	9002503	9002503	Railing Connector	2	Pc	2	44	39269097
	1065191	1065191	Screw-On Front Connector	2	Pc	2	54	39263000



# Drawer System: InnoTech

## ► Internal Accessories



Product	Article No.	SAP	Item Description	Qty.	Unit	PU	MRP	HS Code
<b>Rear Panel Connector</b>								
	<b>Finish : Silver</b>							
	1062501	1062501	Rear panel Connector 70 mm, L -Silver	1	Pc	1	284	83024200
	1062502	1062502	Rear panel Connector70 mm, R -Silver	1	Pc	1	284	83024200
	9007355	9007355	Rear panel Connector 144 mm, L -Silver	1	Pc	1	323	83024200
	9007356	9007356	Rear panel Connector 144 mm, R -Silver	1	Pc	1	323	83024200
	9027831	9027831	Rear panel Connector 176 mm, L -Silver	1	Pc	1	669	83024200
9027832	9027832	Rear panel Connector 176 mm, R -Silver	1	Pc	1	669	83024200	
<b>Cover Cap</b>								
	9194646	9194646	Cover Cap Grey	2	Pc	2	40	39269097
<b>Quadro V6</b>								
	45310-L	9126554	Innotech 350 mm - Quadro-V6	1	Pc	1	1,687	83024200
	45310-R	9126555	Innotech 350 mm - Quadro-V6	1	Pc	1	1,687	83024200
	45311-L	9126558	InnoTech- 420 mm - Quadro-V6	1	Pc	1	1,673	83024200
	45311-R	9126559	InnoTech- 420 mm - Quadro-V6	1	Pc	1	1,673	83024200
	45312-L	9126556	InnoTech- 470 mm - Quadro-V6	1	Pc	1	1,528	83024200
	45312-R	9126557	InnoTech- 470 mm - Quadro-V6	1	Pc	1	1,528	83024200
	45313-L	9126562	InnoTech- 520 mm - Quadro-V6	1	Pc	1	1,610	83024200
	45313-R	9126563	InnoTech- 520 mm - Quadro-V6	1	Pc	1	1,610	83024200
<b>Quadro V6+</b>								
	48360-L	9102862	InnoTech- 420 mm - Quadro-V6+	1	Pc	1	2,249	83024200
	48360-R	9102864	InnoTech- 420 mm - Quadro-V6+	1	Pc	1	2,249	83024200
	48361-L	9133792	InnoTech- 470 mm - Quadro-V6+	1	Pc	1	2,091	83024200
	48361-R	9133793	InnoTech- 470 mm - Quadro-V6+	1	Pc	1	2,091	83024200
	48362-L	9102868	InnoTech- 520 mm - Quadro-V6+	1	Pc	1	2,181	83024200
	48362-R	9102870	InnoTech- 520 mm - Quadro-V6+	1	Pc	1	2,181	83024200
	40271-L	9126394	InnoTech- 620 mm - Quadro-V6+	1	Pc	1	2,414	83024200
	40271-R	9126395	InnoTech- 620 mm - Quadro-V6+	1	Pc	1	2,414	83024200
<b>Partial Extension</b>								
	9158991	9158991	InnoTech- 470 mm - Quadro 25 - L	1	Pc	1	933	83024200
	9158993	9158993	InnoTech- 470 mm - Quadro 25 - R	1	Pc	1	933	83024200
<b>PTO Full Extension 30 Kg</b>								
	9143499	9143499	InnoTech- 470 mm - Quadro V6 EB 9.5	1	Set	1	4,620	83024200
	9143500	9143500	InnoTech- 520 mm - Quadro V6 EB 9.5	1	Set	1	4,670	83024200

# New Kitchen Accessories

► Iron Grey Finish



Product	Article No.	SAP	Item Description	Qty.	Unit	PU	MRP	HS Code
	<b>Lift Basket</b>							
	9346278	9346278	Lift Basket 600mm (W x D x H) - 562 x 265 x 546 mm	1	Pc	1	22,500	83024200
	9346280	9346280	Lift Basket 900mm (W x D x H) - 862 x 265 x 546 mm	1	Pc	1	24,500	83024200
	<b>Magic Corner</b>							
	9346281	9346281	Magic Corner (W x D x H) - 608 x 455 x 584 mm	1	Pc	1	28,500	83024200
	<b>Duo 6 Tier (Order frame and basket for making complete set)</b>							
	9346282	9346282	Duo 6 Tier 450 Frame (W x D x H) - 390 x 500 x 1860 mm	1	Pc	1	20,500	83024200
	9347696	9347696	Duo 6 Tier 450 Basket (W x D x H) - 390 x 500 x 1860 mm	1	Pc	1	15,500	83024200
	9346297	9346297	Duo 6 Tier 600 Frame (W x D x H) - 564 x 500 x 1860 mm	1	Pc	1	21,700	83024200
	9347697	9347697	Duo 6 Tier 600 Basket (W x D x H) - 564 x 500 x 1860 mm	1	Pc	1	17,500	83024200
	<b>Base Duo 2 Tier (Order frame and basket for making complete set)</b>							
	9346302	9346302	Base Duo 2 Tier 600 Frame (W x D x H) - 540 x 500 x 580 mm	1	Pc	1	16,300	83024200
	9347698	9347698	Base Duo 2 Tier 600 Basket (W x D x H) - 540 x 500 x 580 mm	1	Pc	1	6,100	83024200
	<b>Larder 6 Tier (Order frame and basket for making complete set)</b>							
	9346304	9346304	Larder 6 Tier 600 Frame (W x D x H) - 532 x 500 x 1828 mm	1	Pc	1	19,100	83024200
	9347699	9347699	Larder 6 Tier 600 Basket (W x D x H) - 532 x 500 x 1828 mm	1	Pc	1	17,300	83024200
	<b>Pull Outs</b>							
	9346306	9346306	Pull Out 150 mm (W x D x H) - 108 x 461 x 603 mm	1	Pc	1	9,500	83024200
	9346309	9346309	Pull Out 200 mm (W x D x H) - 158 x 461 x 603 mm	1	Pc	1	10,100	83024200
	9346310	9346310	Pull Out 300 mm (W x D x H) - 258 x 461 x 603 mm	1	Pc	1	11,000	83024200

# New Wardrobe Accessories

► Grey & Mocha Finish













Product	Article No.	SAP	Item Description	Qty.	Unit	PU	MRP	HS Code
<b>Leather Classification Box</b>								
	9339711	9339711	Leather Classification Box 600 mm, Grey Finish (W x D x H) - 564(W) x 465(D) x 76(H) mm	1	Pc	1	16,950	83024200
	9339712	9339712	Leather Classification Box 900 mm, Grey Finish (W x D x H) - 864(W) x 465(D) x 76(H) mm	1	Pc	1	19,450	83024200
	9339732	9339732	Leather Classification Box 600 mm, Mocha Finish (W x D x H) - 564(W) x 465(D) x 76(H) mm	1	Pc	1	14,740	83024200
	9339733	9339733	Leather Classification Box 900 mm, Mocha Finish (W x D x H) - 864(W) x 465(D) x 76(H) mm	1	Pc	1	17,440	83024200
<b>Leather Storage Basket</b>								
	9339713	9339713	Leather Storage Basket 600 mm, Grey Finish (W x D x H) - 564(W) x 465(D) x 170(H) mm	1	Pc	1	14,900	83024200
	9339715	9339715	Leather Storage Basket 900 mm, Grey Finish (W x D x H) - 864(W) x 465(D) x 170(H) mm	1	Pc	1	17,670	83024200
	9339734	9339734	Leather Storage Basket 600 mm, Mocha Finish (W x D x H) - 564(W) x 465(D) x 170(H) mm	1	Pc	1	15,040	83024200
	9339735	9339735	Leather Storage Basket 900 mm, Mocha Finish (W x D x H) - 864(W) x 465(D) x 170(H) mm	1	Pc	1	17,740	83024200
<b>Rattan Lile Basket</b>								
	9339716	9339716	Rattan Lile Basket 600 mm, Grey Finish (W x D x H) - 564(W) x 460(D) x 170(H) mm	1	Pc	1	12,880	83024200
	9339717	9339717	Rattan Lile Basket 900 mm, Grey Finish (W x D x H) - 864(W) x 460(D) x 170(H) mm	1	Pc	1	15,650	83024200
	9339736	9339736	Rattan Lile Basket 600 mm, Mocha Finish (W x D x H) - 564(W) x 460(D) x 170(H) mm	1	Pc	1	12,630	83024200
	9339737	9339737	Rattan Lile Basket 900 mm, Mocha Finish (W x D x H) - 864(W) x 460(D) x 170(H) mm	1	Pc	1	14,440	83024200
<b>Leather Drawer with Password &amp; Fingerprint</b>								
	9339718	9339718	Leather Drawer with Password & Fingerprint 600 mm, Grey Finish (W x D x H) - 564(W) x 400(D) x 150(H) mm	1	Pc	1	25,090	83024200
	9339885	9339885	Leather Drawer with Password & Fingerprint 550 mm, Mocha Finish (W x D x H) - 475(W) x 425(D) x 160(H) mm	1	Pc	1	32,490	83024200

# New Wardrobe Accessories

► Grey & Mocha Finish



















Product	Article No.	SAP	Item Description	Qty.	Unit	PU	MRP	HS Code
<b>Trousers Rack</b>								
	9339719	9339719	Trousers Rack 600 mm, Grey Finish (W x D x H) - 564(W) x 465(D) x 76(H) mm	1	Pc	1	10,090	83024200
	9339720	9339720	Trousers Rack 900 mm, Grey Finish (W x D x H) - 864(W) x 465(D) x 76(H) mm	1	Pc	1	12,270	83024200
	9339886	9339886	Trousers Rack 600 mm, Mocha Finish (W x D x H) - 564(W) x 465(D) x 76(H) mm	1	Pc	1	9,500	83024200
	9339887	9339887	Trousers Rack 900 mm, Mocha Finish (W x D x H) - 864(W) x 465(D) x 76(H) mm	1	Pc	1	11,310	83024200
<b>Board Type Shoe Rack</b>								
	9339663	9339663	Board Type Shoe Rack 600 mm - Grey Finish (W x D x H) - 564(W) x 465(D) x 175(H) mm	1	Pc	1	14,210	83024200
	9339664	9339664	Board Type Shoe Rack 900 mm - Grey Finish (W x D x H) - 864(W) x 465(D) x 175(H) mm	1	Pc	1	16,570	83024200
	9339919	9339919	Board Type Shoe Rack 600 mm - Mocha Finish (W x D x H) - 564(W) x 465(D) x 175(H) mm	1	Pc	1	12,030	83024200
	9339920	9339920	Board Type Shoe Rack 900 mm - Mocha Finish (W x D x H) - 864(W) x 465(D) x 175(H) mm	1	Pc	1	13,840	83024200
<b>Flannelette Sorting Box</b>								
	9339666	9339666	Flannelette Sorting Box 600 mm - Grey Finish (W x D x H) - 564(W) x 460(D) x 71(H) mm	1	Pc	1	16,380	83024200
	9339667	9339667	Flannelette Sorting Box 900 mm - Grey Finish (W x D x H) - 864(W) x 460(D) x 71(H) mm	1	Pc	1	18,880	83024200
	9339923	9339923	Flannelette Sorting Box 600 mm - Mocha Finish (W x D x H) - 564(W) x 460(D) x 71(H) mm	1	Pc	1	14,130	83024200
	9339924	9339924	Flannelette Sorting Box 900 mm - Mocha Finish (W x D x H) - 864(W) x 460(D) x 71(H) mm	1	Pc	1	16,840	83024200
<b>Lateral Pants Rack</b>								
	9339721	9339721	Lateral Pants Rack 500 mm - Grey Finish (W x D x H) - 350(W) x 455(D) x 115(H) mm	1	Pc	1	6,230	83024200
	9339888	9339888	Lateral Pants Rack 500 mm - Mocha Finish (W x D x H) - 350(W) x 455(D) x 115(H) mm	1	Pc	1	6,440	83024200
<b>Top Mounted Pants Rack with Two Row</b>								
	9339722	9339722	Top Mounted Pants Rack with Two Row 700 mm, Grey Finish (W x D x H) - 630(W) x 455(D) x 115(H) mm	1	Pc	1	7,930	83024200
	9339889	9339889	Top Mounted Pants Rack with Two Row 700 mm, Mocha Finish (W x D x H) - 630(W) x 455(D) x 115(H) mm	1	Pc	1	8,140	83024200

# New Wardrobe Accessories

► Grey & Mocha Finish









Product	Article No.	SAP	Item Description	Qty.	Unit	PU	MRP	HS Code
<b>Clothes Holder</b>								
	9339723	9339723	Clothes Holder 500 mm - Grey Finish (W x D x H) - 115(W) x 455(D) x 115(H) mm	1	Pc	1	5,220	83024200
	9339890	9339890	Clothes Holder 500 mm - Mocha Finish (W x D x H) - 115(W) x 455(D) x 115(H) mm	1	Pc	1	5,420	83024200
<b>Tie Rack</b>								
	9339724	9339724	Tie Rack - Grey Finish (W x D x H) - 100(W) x 430(D) x 80(H) mm	1	Pc	1	2,180	83024200
	9339911	9339911	Tie Rack - Mocha Finish (W x D x H) - 100(W) x 430(D) x 80(H) mm	1	Pc	1	2,370	83024200
<b>Wardrobe Lift</b>								
	9339725	9339725	Wardrobe Lift 580 mm - Grey Finish (W x D x H) - 540-690(W) x 140(D) x 820(H) mm	1	Pc	1	5,490	83024200
	9339726	9339726	Wardrobe Lift 960 mm - Grey Finish (W x D x H) - 920-1240(W) x 140(D) x 820(H) mm	1	Pc	1	5,490	83024200
	9339913	9339913	Wardrobe Lift 580 mm - Mocha Finish (W x D x H) - 540-690(W) x 140(D) x 820(H) mm	1	Pc	1	5,750	83024200
	9339914	9339914	Wardrobe Lift 960 mm - Mocha Finish (W x D x H) - 920-1240(W) x 140(D) x 820(H) mm	1	Pc	1	5,750	83024200
<b>Clothes Rack Set</b>								
	9339727	9339727	Clothes Rack Set Square Rod - Grey Finish (W x D x H) - 3000(W) x 12(D) x 30(H) mm	1	Pc	1	2,440	83024200
	9339728	9339728	Clothes Rack Set Side Mount - Grey Finish (W x D x H) - 22(W) x 15(D) x 78(H) mm	1	Pc	1	570	83024200
	9339729	9339729	Clothes Rack Set Top Mount - Grey Finish (W x D x H) - 22(W) x 15(D) x 78(H) mm	1	Pc	1	570	83024200
	9339916	9339916	Clothes Rack Set Square Rod - Mocha Finish (W x D x H) - 3000(W) x 12(D) x 30(H) mm	1	Pc	1	2,540	83024200
	9339917	9339917	Clothes Rack Set Side Mount - Mocha Finish (W x D x H) - 22(W) x 15(D) x 78(H) mm	1	Pc	1	620	83024200
	9339918	9339918	Clothes Rack Set Top Mount - Mocha Finish (W x D x H) - 22(W) x 15(D) x 78(H) mm	1	Pc	1	620	83024200
<b>Ironing Board</b>								
	9339669	9339669	Ironing Board 400 mm - Grey Finish (W x D x H) - 295(W) x 430(D) x 140(H) mm	1	Pc	1	9,310	83024200
								



# New Wardrobe Accessories

► Grey & Mocha Finish



Product	Article No.	SAP	Item Description	Qty.	Unit	PU	MRP	HS Code
	<b>Revolve Mirror</b>							
	9339665	9339665	Revolve Mirror 350 mm - Grey Finish (W x H) - 350(W) x 1000(H) mm	1	Pc	1	5,940	83024200
	<b>Revolve Mirror</b>							
	9339922	9339922	Revolve Mirror 350 mm - Mocha Finish (W x H) - 350(W) x 1000(H) mm	1	Pc	1	5,770	83024200
	<b>Top Mounted Clothes Rack</b>							
	9339668	9339668	Top Mounted Clothes Rack 800 mm, Grey Finish (W x D x H) - 525(W) x 525(D) x 125(H) mm	1	Pc	1	5,700	83024200
	<b>Top Mounted Clothes Rack</b>							
	9339925	9339925	Top Mounted Clothes Rack 800 mm, Mocha Finish (W x D x H) - 525(W) x 525(D) x 125(H) mm	1	Pc	1	5,720	83024200
	<b>360° Shoe Rack (Order frame, layer &amp; slide for making complete set)</b>							
	9339670	9339670	360° Shoe Rack 4 Tier (Frame), Grey Finish (W x D x H) - 700(W) x 360(D) x 790-990(H) mm	1	Pc	1	7,125	83024200
	9347734	9347734	360° Shoe Rack 4 Tier (Layer), Grey Finish (W x D x H) - 700(W) x 360(D) x 790-990(H) mm	1	Pc	1	11,010	83024200
	9347735	9347735	360° Shoe Rack 4 Tier (Slide), Grey Finish (W x D x H) - 700(W) x 360(D) x 790-990(H) mm	1	Pc	1	7,915	83024200
	9339731	9339731	360° Shoe Rack 12 Tier (Frame), Grey Finish (W x D x H) - 700(W) x 360(D) x 1910-2110(H) mm	1	Pc	1	7,525	83024200
	9347736	9347736	360° Shoe Rack 12 Tier (Layer), Grey Finish (W x D x H) - 700(W) x 360(D) x 1910-2110(H) mm	1	Pc	1	22,455	83024200
	9347737	9347737	360° Shoe Rack 12 Tier (Slide), Grey Finish (W x D x H) - 700(W) x 360(D) x 1910-2110(H) mm	1	Pc	1	7,920	83024200
	<b>360° Shoe Rack (Order frame, layer &amp; slide for making complete set)</b>							
	9339926	9339926	360° Shoe Rack 4 Tier (Frame), Mocha Finish (W x D x H) - 700(W) x 360(D) x 790-990(H) mm	1	Pc	1	7,550	83024200
	9347738	9347738	360° Shoe Rack 4 Tier (Layer), Mocha Finish (W x D x H) - 700(W) x 360(D) x 790-990(H) mm	1	Pc	1	11,160	83024200
	9347739	9347739	360° Shoe Rack 4 Tier (Slide), Mocha Finish (W x D x H) - 700(W) x 360(D) x 790-990(H) mm	1	Pc	1	8,340	83024200
	9339927	9339927	360° Shoe Rack 12 Tier (Frame), Mocha Finish (W x D x H) - 700(W) x 360(D) x 1910-2110(H) mm	1	Pc	1	7,940	83024200
	9347740	9347740	360° Shoe Rack 12 Tier (Layer), Mocha Finish (W x D x H) - 700(W) x 360(D) x 1910-2110(H) mm	1	Pc	1	22,660	83024200
	9347741	9347741	360° Shoe Rack 12 Tier (Slide), Mocha Finish (W x D x H) - 700(W) x 360(D) x 1910-2110(H) mm	1	Pc	1	8,340	83024200



Cargo Corner Solutions



Cargo Bottle Pull-out



Cargo Under Sink Basket

## Cargo Kitchen Accessories

Space-efficient stainless steel solutions

Kitchen Accessories from Hettich let you organise your kitchen to make it more functional, space-efficient and clutter-free. The range includes wire baskets, storage solutions, corner solutions, overhead solutions, bottle pullouts and other accessories like waste-bin systems, portable dish drainer & cylinder trolley. They are designed to offer a perfect blend of functionality & aesthetics to your home. It comes with a 10 years replacement warranty against rust.

IT'S ALL IN HETTICH.











**Hettich**

Product	Article No.	SAP	Item Description	Qty.	Unit	PU	MRP	HS Code
<b>CargoTech Plain Wire Basket (For 500 mm depth)</b>								
 Height- 100 mm	9156381	9156381	(386 x 500 x 100) Cab.450 mm (15" x 20" x 4")	1	Pc	6	3,580	73239390
	9156383	9156383	(386 x 500 x 150) Cab.450 mm (15" x 20" x 6")	1	Pc	4	4,217	73239390
	9156384	9156384	(386 x 500 x 200) Cab.450 mm (15" x 20" x 8")	1	Pc	3	4,860	73239390
 Height- 150 mm	9156385	9156385	(436 x 500 x 100) Cab.500 mm (17" x 20" x 4")	1	Pc	6	3,886	73239390
	9156386	9156386	(436 x 500 x 150) Cab.500 mm (17" x 20" x 6")	1	Pc	4	4,465	73239390
	9156387	9156387	(436 x 500 x 200) Cab.500 mm (17" x 20" x 8")	1	Pc	3	5,143	73239390
 Height- 200 mm	9159547	9159547	(486 x 500 x 100) Cab.550 mm (19" x 20" x 4")	1	Pc	6	4,009	73239390
	9159548	9159548	(486 x 500 x 150) Cab.550 mm (19" x 20" x 6")	1	Pc	4	4,716	73239390
	9159549	9159549	(486 x 500 x 200) Cab.550 mm (19" x 20" x 8")	1	Pc	3	5,423	73239390
	9156388	9156388	(536 x 500 x 100) Cab.600 mm (21" x 20" x 4")	1	Pc	6	4,223	73239390
	9156389	9156389	(536 x 500 x 150) Cab.600 mm (21" x 20" x 6")	1	Pc	4	4,960	73239390
	9156390	9156390	(536 x 500 x 200) Cab.600 mm (21" x 20" x 8")	1	Pc	3	5,697	73239390
	9156391	9156391	(836 x 500 x 100) Cab.900 mm (33" x 20" x 4")	1	Pc	6	5,717	73239390
	9156392	9156392	(836 x 500 x 150) Cab.900 mm (33" x 20" x 6")	1	Pc	4	6,678	73239390
	9156393	9156393	(836 x 500 x 200) Cab.900 mm (33" x 20" x 8")	1	Pc	3	7,641	73239390
<b>CargoTech Inlets (for 500 mm depth)</b>								
 Thali Inlet	9156342	9156342	Thali Inlet, height-200 mm	1	Pc	5	1,458	73239390
	9156343	9156343	Plate Inlet, height-200 mm	1	Pc	5	1,611	73239390
 Plate Inlet	9156344	9156344	Cup & Saucer Inlet, height 150 mm	1	Pc	5	1,534	73239390
	9156345	9156345	Saucer Inlet, height 100 mm	1	Pc	10	1,227	73239390
 Cup & Saucer Inlet	9156346	9156346	Cup Inlet, height 100 mm	1	Pc	10	1,073	73239390
	9156347	9156347	Bottle Separator Inlet, height 200 mm	1	Pc	3	606	73239390
 Basket Divider Inlet	9156408	9156408	Basket Divider Inlet, height 100 mm	1	Pc	5	843	73239390
	9156409	9156409	Basket Divider Inlet, height 150 mm	1	Pc	5	920	73239390
	9156410	9156410	Basket Divider Inlet, height 200 mm	1	Pc	5	1,073	73239390
 CT Cutlery Inlet	9190416	9190416	CT Cutlery Inlet for 500 mm depth- 100 mm	1	Pc	10	1,073	73239390
	9190417	9190417	CT Cutlery Inlet for 500 mm depth- 144 mm	1	Pc	10	1,151	73239390
<b>Cargo Cutlery Basket</b>								
 Cargo Cutlery Basket	9279342	9279342	Cargo Cutlery Basket W 386 (386 x 500x 94)	1	Pc	1	2,520	73239390
	9275311	9275311	Cargo Cutlery Basket W 436 (436 x 500x 94)	1	Pc	1	3,468	73239390
	9275312	9275312	Cargo Cutlery Basket W 486 (486 x 500x 94)	1	Pc	1	3,735	73239390
	9270287	9270287	Cargo Cutlery Basket W 536 (536 x 500x 94)	1	Pc	1	4,002	73239390



Cargo Cutlery Basket



Product	Article No.	SAP	Item Description	Qty.	Unit	PU	MRP	HS Code
<b>Under Sink Basket Cargo Series</b>								
	9190451	9190451	UnderSink Basket- 900 mm	1	Pc	1	8,432	73239390
<b>Detergent Holder Cargo Series</b>								
	9197058	9197058	Detergent Holder Cargo Series (Recommended shutter width 450 mm)	1	Set	1	2,325	73239390
<b>Dish Drainer Set Cargo Series</b>								
	9206160	9206160	Dish Drainer Set- 600 mm	1	Set	1	5,226	73239390
	9206161	9206161	Dish Drainer Set- 900 mm	1	Set	1	7,275	73239390
<b>Portable Dish Drainer</b>								
	9267212	9267212	Cargo Portable Dish Drainer	1	Pc	1	3,200	73239390
	9190453	9190453	Collecting cargo PVC Tray 600 mm	1	Pc	1	374	39263090
	9267309	9267309	Acrylic sheet Portable Drainer	1	Pc	1	531	39263090
<b>Dish Drainer Set</b>								
	9219096	9219096	Cargo Dish Rack with Draining Board 600 mm	1	Set	1	5,306	94039010
	9219097	9219097	Cargo Dish Rack with Draining Board 900 mm	1	Set	1	7,433	94039010
<b>Pull Out Shelf - Wall unit</b>								
	9209343	9209343	W 536 mm x D 250 mm x H 41 Cab.600 mm	1	Set	2	2,811	73239390
	9210437	9210437	W 686 mm x D 250 mm x H 41 mm Cab.750 mm	1	Set	2	3,655	73239390
	9209346	9209346	W 836 mm x D 250 mm x H 41 Cab.900 mm	1	Set	2	4,375	73239390
<b>Round Bin Holder Cargo Series</b>								
	9210444	9210444	Round Bin Holder 200 Series	1	Pc	1	1,520	73239390
<b>CargoTech Accessories</b>								
	1180142	1180142	Clamps for KA	1	Set	1	56	83024200
	9160975	9160975	Clamps for Quadro	1	Set	1	56	83024200
	9200681	9200681	Cargo IQ 200 Series Clamp for Quadro Left Set	1	Set	1	161	94039000
	9200682	9200682	Cargo IQ 200 Series Clamp for Quadro Right Set	1	Set	1	161	94039000
	9162315	9162315	End Connector for inlets	1	Set	1	34	83024200

Product	Article No.	SAP	Item Description	Qty.	Unit	PU	MRP	HS Code
	<b>CargoPlus (CP) Supplied with clamps &amp; side holder</b>							
	9216602	9216602	CP Plain W 312mm, for IT 470 mm NL, Cab.450mm	1	Pc	4	2,360	73239390
	9216603	9216603	CP Plain W 462mm, For IT 470 mm NL, Cab.600mm	1	Pc	4	2,830	73239390
	9216604	9216604	CP Plain W 762mm, For IT 470 mm NL, Cab.900mm	1	Pc	4	4,172	73239390
	9216605	9216605	CP Plain W 312mm, for IT 520 mm NL, Cab.450mm	1	Pc	4	2,489	73239390
	9216606	9216606	CP Plain W 462mm, For IT 520 mm NL, Cab.600mm	1	Pc	4	3,015	73239390
	9216607	9216607	CP Plain W 762mm, For IT 520 mm NL, Cab.900mm	1	Pc	4	4,270	73239390
			Order along with IT 470/520					
	<b>CargoPlus (Thali Inlets) Supplied with clamps &amp; side holder</b>							
	9216608	9216608	CP Thali W 312mm, for IT 470mm NL, Cab.450mm	1	Pc	3	2,740	73239390
	9216611	9216611	CP Thali W 312mm, for IT 520mm NL, Cab.450mm	1	Pc	3	2,829	73239390
	9216614	9216614	CP Thali W 462mm, For IT 470mm NL, Cab.600mm	1	Pc	3	3,099	73239390
	9216617	9216617	CP Thali W 462mm, For IT 520mm NL, Cab.600mm	1	Pc	3	3,276	73239390
			Order along with IT 470/520					
	<b>CargoPlus (Plate Inlets) Supplied with clamps &amp; side holder</b>							
	9216609	9216609	CP Plate W 312mm, for IT 470mm NL, Cab.450mm	1	Pc	4	2,830	73239390
	9216612	9216612	CP Plate W 312mm, for IT 520mm NL, Cab.450mm	1	Pc	4	2,919	73239390
	9216615	9216615	CP Plate W 462mm, For IT 470mm NL, Cab.600mm	1	Pc	4	3,403	73239390
	9216618	9216618	CP Plate W 462mm, For IT 520mm NL, Cab.600mm	1	Pc	4	3,575	73239390
			Order along with IT 470/520					
	<b>CargoPlus (Cup &amp; Saucer Inlets) Supplied with clamps &amp; side holder</b>							
	9216610	9216610	CP Cup & Saucer W 312mm, for IT 470mm NL, Cab.450 mm	1	Pc	6	2,694	73239390
	9216613	9216613	CP Cup & Saucer W 312mm, for IT 520mm NL, Cab.450 mm	1	Pc	6	2,818	73239390
	9216616	9216616	CP Cup & Saucer W 462mm, For IT 470mm NL, Cab.600 mm	1	Pc	6	3,242	73239390
	9216619	9216619	CP Cup & Saucer W 462mm, For IT 520mm NL, Cab.600 mm	1	Pc	6	3,410	73239390
			Order along with IT 470/520					
	<b>CargoPlus (Thali/Plate Inlets) Supplied with clamps &amp; side holder</b>							
	9216620	9216620	CP Thali/Plate W 762 mm, For IT 470 mm NL, Cab.900 mm	1	Pc	3	4,499	73239390
	9216621	9216621	CP Thali/Plate W 762 mm, For IT 520 mm NL, Cab.900 mm	1	Pc	3	4,720	73239390
			Order along with IT 470/520					



Product	Article No.	SAP	Item Description	Qty.	Unit	PU	MRP	HS Code
<b>CargoTech M (Plain Wire Basket - 500 mm depth) Supplied with KA clamps</b>								
	9190382	9190382	CTM Plain (386x500x100) Cab.450 mm	1	Pc	6	2,360	73239390
	9190383	9190383	CTM Plain (386x500x150) Cab.450 mm	1	Pc	4	2,860	73239390
	9190384	9190384	CTM Plain (386x500x200) Cab.450 mm	1	Pc	3	3,252	73239390
	9190385	9190385	CTM Plain (436x500x100) Cab.500 mm	1	Pc	6	2,467	73239390
	9190386	9190386	CTM Plain (436x500x150) Cab.500 mm	1	Pc	4	2,913	73239390
	9190387	9190387	CTM Plain (436x500x200) Cab.500 mm	1	Pc	3	3,559	73239390
	9190388	9190388	CTM Plain (486x500x100) Cab.550 mm	1	Pc	6	2,594	73239390
	9190389	9190389	CTM Plain (486x500x150) Cab.550 mm	1	Pc	4	3,134	73239390
	9190390	9190390	CTM Plain (486x500x200) Cab.550 mm	1	Pc	3	3,721	73239390
	9190401	9190401	CTM Plain (536x500x100) Cab.600 mm	1	Pc	6	2,400	73239390
	9190402	9190402	CTM Plain (536x500x150) Cab.600 mm	1	Pc	4	2,881	73239390
	9190403	9190403	CTM Plain (536x500x200) Cab.600 mm	1	Pc	3	3,361	73239390
	9190404	9190404	CTM Plain (836x500x100) Cab.900 mm	1	Pc	6	3,549	73239390
	9190405	9190405	CTM Plain (836x500x150) Cab.900 mm	1	Pc	4	4,287	73239390
	9190406	9190406	CTM Plain (836x500x200) Cab.900 mm	1	Pc	3	5,083	73239390
<b>CargoTech M (Thali Inlet) Supplied with KA clamps</b>								
	9194315	9194315	CTM Thali (386x500x200) Cab.450 mm	1	Pc	3	3,540	73239390
	9194317	9194317	CTM Thali (436x500x200) Cab.500 mm	1	Pc	3	3,832	73239390
	9194319	9194319	CTM Thali (486x500x200) Cab.550 mm	1	Pc	3	4,173	73239390
<b>CargoTech M (Cup &amp; Saucer Inlet) Supplied with KA clamps</b>								
	9194314	9194314	CTM Cup & Saucer (386x500x100) Cab.450 mm	1	Pc	6	2,951	73239390
<b>CargoTech M (Saucer/Jar Inlet) Supplied with KA clamps</b>								
	9194316	9194316	CTM Cup & Saucer/Jar (436x500x100) Cab.500 mm	1	Pc	6	3,303	73239390
	9194318	9194318	CTM Cup & Saucer/Jar (486x500x100) Cab.550 mm	1	Pc	6	4,014	73239390
	9194320	9194320	CTM Cup & Saucer/Jar (536x500x100) Cab.600 mm	1	Pc	6	4,014	73239390
<b>CargoTech M (Thali/Jar Inlet) Supplied with KA clamps</b>								
	9194321	9194321	CTM Thali/Jar (536x500x200) Cab.600 mm	1	Pc	3	4,267	73239390
<b>CargoTech M (Thali/Plate/Jar Inlet) Supplied with KA clamps</b>								
	9194322	9194322	CTM Thali/Plate/Jar (836x500x200) Cab.900 mm	1	Pc	3	6,038	73239390

Product	Article No.	SAP	Item Description	Qty.	Unit	PU	MRP	HS Code
	<b>Moving Corner for blind corner cabinet, 900 / 1000 mm width - Chrome Finish</b>							
	9221242	9221242	Moving Corner Cargo Series set of 4 baskets - Chrome Finish	1	Set	1	8,342	73239390
	9221243	9221243	Moving Corner Cargo Series Right mechanism - Chrome Finish	1	Set	1	38,120	94039010
	9221244	9221244	Moving Corner Cargo Series Left mechanism - Chrome Finish	1	Set	1	38,120	94039010
	<b>Moving Corner for blind corner cabinet, 900 / 1000 mm width - Anthracite Finish</b>							
	9292190	9292190	Moving Corner Cargo Series set of 4 baskets - Anthracite Finish	1	Set	1	31,930	73239390
	9292176	9292176	Moving Corner Cargo Series Right mechanism - Anthracite Finish	1	Set	1	38,120	94039010
	9292177	9292177	Moving Corner Cargo Series Left mechanism - Anthracite Finish	1	Set	1	38,120	94039010
	<b>Carousel</b>							
	70549	9083464	Carousel D-1/2 for Ø750 Arena Classic - Chrome Finish	1	Set	1	52,440	94039010
	70550	9083480	Carousel D-1/2 for Ø850 Arena Classic - Chrome Finish	1	Set	1	56,460	94039010
	<b>Carousel cargo series - Chrome Finish</b>							
	9219462	9219462	Cargo 3/4 Carousel 2 Shelves 2 Flat Chrome White Base - Chrome Finish	1	Set	1	32,160	94039010
	9219465	9219465	Cargo 3/4 Carousel M 2 Shelves 1 Round Chrome White Base - Chrome Finish	1	Set	1	25,730	94039010
	<b>3/4 Carousel - Anthracite Finish</b>							
	9292174	9292174	Cargo 3/4 Carousel 2 Shelves 2 Flat - Anthracite Finish	1	Set	1	32,160	94039010
	9292175	9292175	Cargo 3/4 Carousel M 2 Shelves 1 Round - Anthracite Finish	1	Set	1	25,730	94039010
	<b>CargoMan for Blind corner cabinet, 900/1000 mm width - Chrome Finish</b>							
	9161971	9161971	CargoMan Corner Pull Out 450 LH-Chrome Finish	1	Set	1	42,030	94039010
	9161972	9161972	CargoMan Corner Pull Out 450 RH-Chrome Finish	1	Set	1	42,030	94039010
	<b>CargoMan for Blind corner cabinet, 900/1000 mm width - Anthracite</b>							
	9292162	9292162	CargoMan Corner Pull Out 450 LH - Anthracite	1	Set	1	42,030	94039010
	9292163	9292163	CargoMan Corner Pull Out 450 RH - Anthracite	1	Set	1	42,030	94039010
	9292164	9292164	CargoMan Corner Pull Out 500 LH - Anthracite	1	Set	1	45,400	94039010
	9292165	9292165	CargoMan Corner Pull Out 500 RH - Anthracite	1	Set	1	45,400	94039010

# Kitchen Accessories

## ► Corner Storage Solutions & Midway Series









Product	Article No.	SAP	Item Description	Qty.	Unit	PU	MRP	HS Code	
<b>Cargoman Soft Close for Blind corner cabinet, 900/1000 mm width – Chrome Finish</b>									
	9218025	9218025	CargoMan Soft Corner Pull Out 450 LH - Chrome Finish	1	Set	1	46,740	94039010	
	9218026	9218026	CargoMan Soft Corner Pull Out 450 RH - Chrome Finish	1	Set	1	46,740	94039010	
	9218027	9218027	CargoMan Soft Corner Pull Out 500 LH - Chrome Finish	1	Set	1	47,630	94039010	
	9218028	9218028	CargoMan Soft Corner Pull Out 500 RH - Chrome Finish	1	Set	1	47,630	94039010	
<b>Cargoman Soft Close for Blind corner cabinet, 900/1000 mm width – Anthracite Finish</b>									
	9292166	9292166	CargoMan Soft Corner Pull Out 450 LH - Anthracite Finish	1	Set	1	46,740	94039010	
	9292167	9292167	CargoMan Soft Corner Pull Out 450 RH - Anthracite Finish	1	Set	1	46,740	94039010	
	9292168	9292168	CargoMan Soft Corner Pull Out 500 LH - Anthracite Finish	1	Set	1	47,630	94039010	
	9292169	9292169	CargoMan Soft Corner Pull Out 500 RH - Anthracite Finish	1	Set	1	47,630	94039010	
<b>Cargoman M for Blind corner cabinet, 900/1000 mm width – Chrome Finish</b>									
	9218021	9218021	CargoMan M Corner Pull Out 450 LH - Chrome Finish	1	Set	1	33,880	94039010	
	9218022	9218022	CargoMan M Corner Pull Out 450 RH - Chrome Finish	1	Set	1	33,880	94039010	
	9218023	9218023	CargoMan M Corner Pull Out 500 LH - Chrome Finish	1	Set	1	35,810	94039010	
	9218024	9218024	CargoMan M Corner Pull Out 500 RH - Chrome Finish	1	Set	1	35,810	94039010	
<b>Cargoman M for Blind corner cabinet, 900/1000 mm width – Anthracite Finish</b>									
	9292170	9292170	CargoMan M Corner Pull Out 450 LH - Anthracite	1	Set	1	33,880	94039010	
	9292171	9292171	CargoMan M Corner Pull Out 450 RH - Anthracite	1	Set	1	33,880	94039010	
	9292172	9292172	CargoMan M Corner Pull Out 500 LH - Anthracite	1	Set	1	35,810	94039010	
	9292173	9292173	CargoMan M Corner Pull Out 500 RH - Anthracite	1	Set	1	35,810	94039010	
<b>Cargo Midway Series</b>									
Jar Rack Multi Purpose Rack, 2-tier Oil Container Rack Saucer Rack Kitchen Roll Holder Railing	9217143	9217143	Jar Rack	1	Set	1	1,680	73239390	
	9217145	9217145	Multi Purpose Rack, 2-tier	1	Set	1	1,680	73239390	
	9217148	9217148	Oil Container Rack	1	Set	1	1,680	73239390	
	9217179	9217179	Saucer Rack	1	Set	1	1,921	73239390	
	9269987	9269987	Kitchen Roll Holder	1	Pc	1	1,921	73239390	
	9267133	9267133	Railing Set, 600 mm	1	Set	1	3,074	83024200	
	9267134	9267134	Railing Set, 900 mm	1	Set	1	3,690	83024200	
	9267135	9267135	Railing Set, 1200 mm	1	Set	1	4,306	83024200	







# Kitchen Accessories

## ► Pull Out Solutions & Waste Bin Solutions



Product	Article No.	SAP	Item Description	Qty.	Unit	PU	MRP	HS Code
<b>Cleaning Utensil Pull-out</b>								
	73549	9148880	Pull-out basket width (1 x 96) + (1 x 185)	1	Set	1	16,430	94039010
<b>Cargo IQ 200 (Bottle Pull out - 2 tier)</b>								
	9161045	9161045	For Cabinet width 150 mm	1	Pc	4	8,312	73239390
	9161046	9161046	For Cabinet width 200 mm	1	Pc	3	9,773	73239390
	9161047	9161047	For Cabinet width 300 mm	1	Pc	2	11,227	73239390
	9160975	9160975	Quadro clamps (as per requirement)	1	Set	1	56	83024200
	1180142	1180142	Telescopic clamps (as per requirement)	1	Set	1	56	83024200
	73280	9209239	KA 5632, Zinc 450 mm	1	Set	1	479	83024200
	9114275	9114275	KA 4532, Silent 450 mm	1	Set	1	1,392	83024200
	45291-L	9099124	Quadro full Extn.Silent System 450 mm 30 kg	1	Pc	1	1,528	83024200
45291-R	9099125	Quadro full Extn.Silent System 450 mm 30 kg	1	Pc	1	1,528	83024200	
<b>Cargo IQ 300 (Bottle Pull out - 2 tier) - Compatible with KA runners only</b>								
	9191703	9191703	For Cabinet width 150 mm	1	Pc	4	4,620	73239390
	9191708	9191708	For Cabinet width 200 mm	1	Pc	3	5,484	73239390
	9247908	9247908	For Cabinet width 240 mm	1	Pc	3	6,096	73239390
	9191711	9191711	For Cabinet width 300 mm	1	Pc	2	6,349	73239390
	1180142	1180142	Telescopic clamps (as per requirement)	1	Set	1	56	83024200
	73280	9209239	KA 5632, Zinc 450 mm	1	Set	1	479	83024200
	9114275	9114275	KA 4532, Silent 450 mm	1	Set	1	1,392	83024200
<b>Spice Pull Out 3 tier - Compatible with KA runners only</b>								
	9210439	9210439	For Cabinet width 150 mm	1	Pc	4	5,498	73239390
	9210441	9210441	For Cabinet width 200 mm	1	Pc	3	6,262	73239390
	9210442	9210442	For Cabinet width 300 mm	1	Pc	2	6,864	73239390
	1180142	1180142	Telescopic clamps (as per requirement)	1	Set	1	56	83024200
	73280	9209239	KA 5632, Zinc 450 mm	1	Set	1	479	83024200
	9114275	9114275	KA 4532, Silent 450 mm	1	Set	1	1,392	83024200
<b>Square Bin Holder</b>								
	9269984	9269984	Square Bin Holder 235 x 170x 205	1	Set	1	1,060	73239390
	9132377	9132377	8L Bin 152 x 225x 295	1	Set	1	1,197	39249000
	9132384	9132384	8L Lid (Grey) 152 x 225x 21	1	Set	1	496	39249000
	9132382	9132382	8L Lid (Green) 152 x 225x 21	1	Set	1	496	39249000
<b>Cargo Pull-Out Bin Holder</b>								
	9269986	9269986	W300 234 x 495 x 315	1	Pc	1	3,222	73239390
	9269985	9269985	W600 (Below Sink) 536 x 225 x 205	1	Pc	1	2,573	73239390
	9132377	9132377	Bin 8L Plastic/grey	1	Pc	1	1,197	39249090
	9132380	9132380	Bin 17L Plastic/grey	1	Pc	1	1,795	39249090
	9132382	9132382	Lid 8L Plastic/green	1	Pc	1	496	39249090
	9132384	9132384	Lid 8L Plastic/grey	1	Pc	1	496	39249090
	9132386	9132386	Lid 17L Plastic/grey	1	Pc	1	1,436	39249090



Product	Article No.	SAP	Item Description	Qty.	Unit	PU	MRP	HS Code
	<b>Cargo Cylinder Trolley</b>							
	9210445	9210445	Cylinder Trolley (Minimum cabinet width 400 mm)	1	Pc	1	1,766	73239390
	<b>Cosario</b>							
	9062032	9062032	600 mm width	1	Set	1	68,833	94039010
	9062035	9062035	900 mm width	1	Set	1	78,506	94039010
	<b>Waterproof Mat</b>							
	9079862	9079862	1200X580 Polystyrene, aluminium look	1	Pc	1	4,336	94039090
	<b>Wicker Baskets with Beech Runner</b>							
	41895*	41895*	320 x 500 x 120 (cabinet width 400 mm)	1	Pc	1	11,110	46021091
	41898*	41898*	320 x 500 x 210 (cabinet width 400 mm)	1	Pc	1	10,680	46021091
	41902*	41902*	320 x 500 x 300 (cabinet width 400 mm)	1	Pc	1	11,380	46021091
	41896*	41896*	420 x 500 x 120 (cabinet width 500 mm)	1	Pc	1	11,660	46021091
	41899*	41899*	420 x 500 x 210 (cabinet width 500 mm)	1	Pc	1	11,100	46021091
	41903*	41903*	420 x 500 x 300 (cabinet width 500 mm)	1	Pc	1	11,960	46021091
	41897*	41897*	520 x 500 x 120 (cabinet width 600 mm)	1	Pc	1	12,390	46021091
	41901*	41901*	520 x 500 x 210 (cabinet width 600 mm)	1	Pc	1	11,620	46021091
	41904*	41904*	520 x 500 x 300 (cabinet width 600 mm)	1	Pc	1	13,800	46021091
	41906*	41906*	Beech Runner for cabinet side 18-19 mm (Order Beech runners separately) *Available still stock last	1	Set	1	2,350	94039030
	<b>Wicker Baskets with Beech Runner (Economical version)</b>							
	9321100*	9321100*	320x500x120 (Cabinet width 400 mm)	1	Set	1	4,790	46021091
	9321103*	9321103*	320x500x210 (Cabinet width 400 mm)	1	Set	1	5,340	46021091
9321106*	9321106*	320x500x300 (Cabinet width 400 mm)	1	Set	1	5,490	46021091	
9321101*	9321101*	420x500x120 (Cabinet width 500 mm)	1	Set	1	5,530	46021091	
9321104*	9321104*	420x500x210 (Cabinet width 500 mm)	1	Set	1	5,900	46021091	
9321107*	9321107*	420x500x300 (Cabinet width 500 mm)	1	Set	1	6,850	46021091	
9321102*	9321102*	520x500x120 (Cabinet width 600 mm)	1	Set	1	6,250	46021091	
9321105*	9321105*	520x500x210 (Cabinet width 600 mm)	1	Set	1	6,660	46021091	
9321108*	9321108*	520x500x300 (Cabinet width 600 mm) *Beech Runner included with above article codes	1	Set	1	7,610	46021091	
	<b>Waste-Bin.It Classic</b>							
	9343581	9343581	Body Stainless steel with Black plastic Bin, 13 litres capacity (Min. cabinet width 365 mm)	1	Set	1	4,019	73239990
	9218233	9218233	Body White lacquered with White plastic Bin, 13 litres capacity (Min. cabinet width 400 mm)	1	Set	1	3,079	73239990
	<b>Bin.it Duo II - 300</b>							
	9132343	9132343	Bin.it Duo II - 300	1	Set	1	19,753	39249000
	<b>BIN.IT EASY 2x7.5I</b>							
	9079929	9079929	BIN.IT EASY 2x7.5I	1	Set	1	13,472	39249000







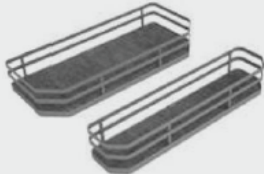

Product	Article No.	SAP	Item Description			Qty.	Unit	PU	MRP	HS Code	
	<b>Cargo Duo Basket Holder Frame</b>		For outer cabinet width (mm)	For inside carcass width (mm)	Min. inside carcass height (mm)						
	9236364	9236364	450	410	1215 4-tier	1	Set	1	58,680	94039010	
	9236366	9236366	450	410	1800 6-tier	1	Set	1	60,572	94039010	
	9236365	9236365	600	560	1215 4-tier	1	Set	1	58,680	94039010	
	9236367	9236367	600	560	1800 6-tier	1	Set	1	60,572	94039010	
	<b>Pull out basket &amp; Door shelf</b>										
	9235979	9235979	For 450 mm cabinet width Pull Out Basket (360 x 220 x 90 mm) Door Shelf Basket (335 x 110 x 90 mm)			1	Set	2	2,209	73239390	
	9235980	9235980	For 600 mm cabinet width Pull Out Basket (510 x 220 x 90 mm) Door Shelf Basket (485 x 110 x 90 mm)			1	Set	2	2,768	73239390	
		<b>Cargo Larder Basket Holder</b>									
9236391		9236391	Cargo Larder Basket Holder			1	Set	1	470	94039010	
<b>Carcass outer width (mm) Full extension Runner 80 kg</b>											
9236381		9236381	Cargo Larder full ext. runner 300 mm (width)			1	Set	1	29,060	94039010	
9236382		9236382	Cargo Larder full ext. runner 400 mm (width)			1	Set	1	29,060	94039010	
9236383		9236383	Cargo Larder full ext. runner 450 mm (width)			1	Set	1	29,060	94039010	
<b>Carcass outer width (mm) Full extension Runner 120 kg</b>											
9236386		9236386	Cargo Larder full ext. runner 300 mm (width)			1	Set	1	35,180	94039010	
9236387		9236387	Cargo Larder full ext. runner 400 mm (width)			1	Set	1	35,180	94039010	
9236388		9236388	Cargo Larder full ext. runner 450 mm (width)			1	Set	1	35,180	94039010	
	<b>Stainless Steel Baskets W x D x H (mm)</b>										
	9235981	9235981	Stainless Steel Baskets 300 (230 x 435 x 115)			1	Pc	4	3,132	73239390	
	9235982	9235982	Stainless Steel Baskets 400 (330 x 435 x 115)			1	Pc	4	3,341	73239390	
	9235983	9235983	Stainless Steel Baskets 450 (380 x 435 x 115)			1	Pc	4	3,548	73239390	
	<b>Cargo Larder (Frame)</b>		Min. inside carcass width	Carcass outer width							
	<b>For Inside carcass height 1615 –1915 mm for 5 layers</b>										
	9236379	9236379	262 (mm)		300 (mm)		1	Set	1	15,250	94039010
			362 (mm)		400 (mm)		1	Set	1	15,250	94039010
			412 (mm)		450 (mm)		1	Set	1	15,250	94039010
	<b>For Inside carcass height 1880 –2180 mm for 6 layers</b>										
	9236380	9236380	262 (mm)		300 (mm)		1	Set	1	15,250	94039010
			362 (mm)		400 (mm)		1	Set	1	15,250	94039010
			412 (mm)		450 (mm)		1	Set	1	15,250	94039010

# Kitchen Accessories

## ► Cabinet Storage Solutions

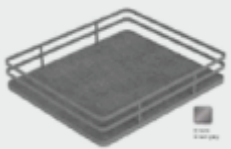
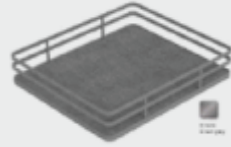

Product	Article No.	SAP	Item Description			Qty.	Unit	PU	MRP	HS Code	
	<b>Cargo Duo Basket Holder Frame-Anthracite Finish</b>			For outer cabinet width (mm)	For inside carcass width (mm)	Min. inside carcass height (mm)					
	9292180	9292180	450	410	1215 4-tier	1	Set	1	58,680	94039010	
	9292178	9292178	450	410	1800 6-tier	1	Set	1	60,572	94039010	
	9292181	9292181	600	560	1215 4-tier	1	Set	1	58,680	94039010	
	9292179	9292179	600	560	1800 6-tier	1	Set	1	60,572	94039010	
	<b>Pull out basket &amp; Door shelf - Anthracite Finish</b>										
	9292191	9292191	Cargo Duo Basket Set for W450			1	Set	1	23,820	94039010	
	9292199	9292199	Cargo Duo Basket Set for W600			1	Set	1	26,920	94039010	
			NOTE: 4 tier requires 2 qty to be billed of the article code & 6 tier requires 3 qty to be billed of the article code								
	<b>Cargo Larder Basket Holder - Anthracite Finish</b>										
	9292200	9292200	Cargo Larder Basket Holder			1	Set	1	378	94039010	
	<b>Cargo Larder Mechanism 80 kg - Anthracite Finish</b>										
	9292187	9292187	Larder 5 Tier H 1615-1915mm W 300mm			1	Set	1	28,953	94039010	
	9292188	9292188	Larder 5 Tier H 1615-1915mm W 400mm			1	Set	1	28,953	94039010	
	9292189	9292189	Larder 5 Tier H 1615-1915mm W 450mm			1	Set	1	28,953	94039010	
	<b>Cargo Larder Mechanism 120 kg - Anthracite Finish</b>										
	9292184	9292184	Larder 6 Tier H 1880-2180mm W 300mm			1	Set	1	35,180	94039010	
	9292185	9292185	Larder 6 Tier H 1880-2180mm W 400mm			1	Set	1	35,180	94039010	
	9292186	9292186	Larder 6 Tier H 1880-2180mm W 450mm			1	Set	1	35,180	94039010	
	<b>Cargo Larder Basket Set of 5 Tiers - Anthracite Finish</b>										
	9292195	9292195	Cargo Larder Basket W230 Set of 5			1	Set	1	34,007	94039010	
	9292196	9292196	Cargo Larder Basket W330 Set of 5			1	Set	1	36,502	94039010	
	9292197	9292197	Cargo Larder Basket W380 Set of 5			1	Set	1	38,784	94039010	
	<b>Cargo Larder Basket Set of 6 Tiers - Anthracite Finish</b>										
	9292192	9292192	Cargo Larder Basket W230 Set of 6			1	Set	1	40,805	94039010	
	9292193	9292193	Cargo Larder Basket W330 Set of 6			1	Set	1	43,802	94039010	
	9292194	9292194	Cargo Larder Basket W380 Set of 6			1	Set	1	46,542	94039010	
	<b>Cargo Larder Frame - Anthracite Finish</b>										
	9292183	9292183	Larder Frame 1615-1915mm - 5 Baskets			1	Set	1	15,250	94039010	
	9292182	9292182	Larder Frame 1880-2180mm - 6 Baskets			1	Set	1	15,250	94039010	

# Wardrobe Accessories

► Special Solutions, Shoe Rack & Pull Out Shelf



Product	Article No.	SAP	Item Description	Qty.	Unit	PU	MRP	HS Code
<b>Garment Lift</b>								
	9079878	9079878	Duo Lift 10 (10 kg) Inside cabinet width 750-1170 mm	1	Pc	1	8,780	83024200
	42507	42507	Duo Lift 15 (15 kg) Inside cabinet width 750-1150 mm	1	Pc	1	10,540	83024200
	9079882	9079882	Duo Lift 18 (18 kg) Inside cabinet width 750-1150 mm	1	Pc	1	15,520	83024200
<b>Wardrobe Tube &amp; Wardrobe Tube Support</b>								
	47615*	47615*	Oval cabinet rail 2000 mm Chrome Gloss	1	Pc	10	1,680	73066990
	9341248	9341248	Oval cabinet rail 2000 mm Chrome Gloss	1	Pc	10	1,314	83024200
	70664*	9056579*	Cabinet rail Support SL 322 (3 screw holes)	1	Pc	10	36	83024200
	9343727	9343727	Cabinet rail Support SL 322 (3 screw holes)	1	Pc	10	36	83024200
	70666	9056573	Cabinet rail Support SL 323 (2 pins+1 screw hole)	1	Pc	10	42	83024200
	70668	70668	SI786 DD OVAL NICKEL	1	Pc	50	104	83024200
*Available still stock last								
<b>Built-in Ironing Board</b>								
	9315928	9315928	Ironing Board Extension (Minimum inside cabinet width 360 - 468 mm)	1	Set	1	23,479	94039090
<b>Shoe cabinet fitting</b>								
	42474	42474	Shoe cabinet fitting	1	Set	1	1,337	39263000
<b>Cargo Pull Out Shoe Rack (Vertical)</b>								
	9209340	9209340	Cargo Pull Out Shoe Rack with accessory plate. For internal cabinet height 750 mm ( W X D X H ) - 279 x 500 x 580 mm (KA runner & clamps to be ordered separately)	1	Set	1	6,611	73262090
<b>Cargo Pull Out Shoe Rack (Horizontal)</b>								
	9217067	9217067	For 600 mm cabinet width with accessory plate.	1	Set	1	5,465	73262090
	9211635	9211635	For 900 mm cabinet width with accessory plate. (KA / Quadro runner & clamps to be ordered separately)	1	Set	1	6,843	73262090
<b>Pull Out Shelf</b>								
	9209345	9209345	W 536 mm x D 500 x H 41, Cabinet 600 mm	1	Set	1	6,575	73262090
	9210438	9210438	W 686 mm x D 500 mm x H 41 mm Cab.750 mm	1	Set	1	7,386	73262090
	9209348	9209348	W 836 mm x D 500 x H 41, Cabinet 900 mm	1	Set	1	8,206	73262090

## Wardrobe Accessories

► Trousers Pull Out, Tie & Belt Pull Out,  
Shoe Rack & Laundry



Product	Article No.	SAP	Item Description	Qty.	Unit	PU	MRP	HS Code
<b>Cargo Trousers Pull Out</b>								
	9221098	9221098	Cargo trousers pull out ( W X D X H ) - 536 x 500 x 120 mm	1	Pc	1	9,189	73262090
	9236898	9236898	Cargo trousers pull out ( W X D X H ) - 836 x 500 x 120 mm (KA runner & clamps to be ordered separately)	1	Pc	1	10,471	73262090
<b>Cargo Trousers Pull Out M</b>								
	9243990	9243990	Cargo trousers pull out ( W X D X H ) - 340 x 500 x 142 mm (KA runner & clamps to be ordered separately)	1	Pc	1	7,952	73262090
<b>Cargo Tie &amp; Belt Pull Out</b>								
	9221099	9221099	Cargo tie & belt pull out ( W X D X H ) - 125 x 500 x 100 mm (KA runner & clamps to be ordered separately)	1	Pc	1	7,864	73262090
<b>Cargo Tie &amp; Belt Pull Out M</b>								
	9243991	9243991	Cargo tie & belt pull out M ( W X D X H ) - 110 x 500 x 68 mm (KA runner & clamps to be ordered separately)	1	Pc	1	6,626	73262090
<b>Cargo wall shoe rack (M)</b>								
	9243992	9243992	Cargo wall shoe rack (M) ( W X D X H ) - 500 x 210 x 238 mm (KA runner & clamps to be ordered separately)	1	Pc	1	4,367	73262090
<b>Cargo Laundry</b>								
	9241012	9241012	Cargo Laundry ( W X D X H ) - 220 x 500 x 580 mm (KA runner & clamps to be ordered separately)	1	Pc	1	6,464	73262090

# Connecting Fittings

## ► Shelf Supports & Suspension Brackets



Product	Article No.	SAP	Item Description	Qty.	Unit	PU	MRP	HS Code
<b>Shelf Supports</b>								
	16180	16180	Safety 5 mm Translucent.	100	Pc	1000	400	83024200
	25090	9127419	Safety 5 mm White	100	Pc	1000	400	83024200
	53012	1011027	Sekura7 Nickel	100	Pc	1000	1,400	83024200
	22737	1006203	Universal D Nickel	100	Pc	1000	740	83024200
	9010111	9010111	Sekura 2.1 Nickel	100	Pc	1000	800	83024200
	79707	9005558	Support Sekura6 Nickel	100	Pc	1000	1,400	83024200
	19557	9010110	Sekura1.1 Nickel	100	Pc	1000	900	83021090
	79709	1056163	PVC/Steel 5 mm for Glass shelf	100	Pc	1000	400	83024200
	47609	1010564	Sekura8 Nickel for Glass shelf	100	Pc	1000	1,700	83024200
	47661	1069728	Titan min. shelf thickness 24 mm	1	Pc	20	124	83024200
<b>Suspension Brackets</b>								
	1066278	1066278	SAH 130 Steel/PVC White Left	1	Pc	25	92	83024200
	1066279	1066279	SAH 130 Steel/PVC White Right	1	Pc	25	92	83024200
	1066339	1066339	Cover Cap Left For SAH 130 White	100	Pc	25	1,200	39269097
	1066338	1066338	Cover Cap Right For SAH 130 White	100	Pc	25	1,200	39269097
	9007651	9007651	Rail B 3000 mm Zinc	1	Pc	1	1,172	83024200
	9208678	9208678	Rail L 130 mm Zinc	1	Pc	1	108	83024200
	46103	46103	Suspension Hook Ø6 X 50 mm + Wall pulg Ø8 X 40 mm	100	Pc	100	2,600	83024200
	65480	65480	Special screw Ø5.5 x 50 mm + Wall pulg Ø8 X 40 mm	100	Pc	100	2,800	83024200
	9349769	9349769	SAH 215 (Lift Off Guard) with Plate & White Cover Caps – 45 kg	1	Set	10	540	83024200
	9349770	9349770	SAH 216 (Lift Off Guard) with Plate & White Cover Caps – 55 kg	1	Set	10	590	83024200



# Connecting Fittings

► Rastex, Rapid Dowels, VB Connectors & Misc. Connectors



Product	Article No.	SAP	Item Description	Qty.	Unit	PU	MRP	HS Code
	<b>Rastex 3 Part with 10 mm Socket</b>							
	9056601	9056601	Rastex 15/18 Zinc/Nickel Cam	1	Pc	2000	8	83024200
	9047865	9047865	Twister screw in Dowel DU644 - M6 x 7.8 mm	1	Pc	2000	6	73181499
	9298671	9298671	Socket No.33 - 10 mm, Plastic	1	Pc	2,000	3	39269097
	BOM Code	9323001					17	
	<b>Rastex 3 Part with 8 mm Socket</b>							
	9056601	9056601	Rastex 15/18 Zinc/Nickel Cam	1	Pc	2000	8	83024200
	9047865	9047865	Twister screw in Dowel DU644 - M6 x 7.8 mm	1	Pc	2000	6	73181499
	9298672	9298672	Socket (Plastic) no. 49 M6 - 8 mm	1	Pc	2,000	2	39269097
	BOM Code	9323002					16	
	<b>Rastex- 2 Part Set</b>							
	9056601	9056601	Rastex 15/18 Zinc/Nickel Cam	1	Pc	2000	8	83024200
	9047861	9047861	Twister screw in Dowel DU 232T - Ø 5 mm	1	Pc	2000	7	73181499
	BOM Code	9323003					15	
	<b>Rastex Cover Cap for Rastex 15 without rim</b>							
	1008524	1008524	Cover Cap Rastex 15 White	100	Pc	5000	100	39269097
	1008525	1008525	Cover Cap Rastex 15 Brown	100	Pc	5000	100	39269097
	1009563	1009563	Cover Cap Rastex 15 Black	100	Pc	5000	100	39269097
	<b>Rastex Misc.</b>							
	9064684	9064684	Rastex (Cam) 15/15 nickel plated.	100	Pc	2000	800	83024200
	13962	9056599	Rastex 15 without rim/18 Bright	100	Pc	2000	800	83024200
	1079580	1079580	Double Dowel Du853 chrome with seeger circle ring	1	Pc	2000	37	83024200
	<b>VB Connectors</b>							
	47454	47454	VB 21 for 19 - 20 mm shelves, without rib.	1	Pc	200	79	83024200
	65529	9143778	VB 36 / 19 for 19 mm shelves, without rib nickel plated	1	Pc	200	72	83024200
	9039828	9039828	Screw in dowel DU 327 Steel Bright, Drill dia 5 mm	100	Pc	2000	760	73181499
	9116929	9116929	VB 35 / 19 for 19 mm shelves, without rib. White	1	Pc	200	17	94039010
	65513	9143776	VB 35 / 19 for 19 mm shelves, without rib. nickel plated	1	Pc	200	48	83024200
	74688	74688	Screw in dowel DU 321, Drill dia 5 mm	100	Pc	2000	860	83024200
	<b>Connectors Misc.</b>							
	79438	79438	Rear-panel connector RV 8	100	Pc	200	600	94039090

# Connecting Fittings

► Plastic Socket, Wooden Dowel & Magnetic Catches,  
Franke Fittings, Cabinet Connector & Misc. Fittings



Product	Article No.	SAP	Item Description	Qty.	Unit	PU	MRP	HS Code
<b>Franke Fittings</b>								
	9060089	9060089	Franko-Flex 90°, 10 Positions (44745)	1	Pc	100	960	83024200
	9130900	9130900	Cover Cap Chrome for Round Link Vario-Flex	1	Pc	100	215	83024200
	9125137	9125137	Vario-Flex 0-90° with Round Link Chromed	1	Pc	100	1,140	83024200
	9125138	9125138	Vario-Flex 270-360° with Round Link Chromed	1	Pc	100	1,140	83024200
<b>Cabinet Connector</b>								
	1072394	1072394	VHS 32/35 28-36 mm	100	Pc	1000	567	73181692
	1072393	1072393	VHS 32/35 36-44 mm	100	Pc	1000	740	73181900
	1058986	1058986	VHS Screw SMG M4x15 (To be ordered along with VHS 32/35)	100	Pc	2000	200	73181558
<b>Misc Fittings</b>								
	46080	1009684	Multi-Clip PVC Black	100	Pc	200	2,500	39263000
	9302837	9302837	Universal angle 31x31 mm	100	Pc	1000	1,500	83024200
	9302840	9302840	Universal Angle 41x41 mm	100	Pc	100	1,600	83024200
<b>Plastic Socket</b>								
	1004932	1004932	Expanding Socket 43 Ø5 L13 PL	100	Pc	10000	140	39269097
	1004933	1004933	Expanding Socket 66 Ø5 L9 PL	100	Pc	10000	200	39269097
	1001097	1001097	T43 Hinge Screws Ø10 x 11 mm	100	Pc	5000	300	73181558
	1058613	1058613	T43 Hinge Sockets Ø10 mm	100	Pc	10000	500	39269097
<b>Wooden Dowel</b>								
	9290706	9290706	Wooden Dowel 8.0 X 30 mm	100	Pc	2000	91	44219999
	9102465	9102465	Wooden Dowel 8.0 X 40 mm	100	Pc	2000	91	44219999
	9290708	9290708	Wooden Dowel 6.0 X 35 mm	100	Pc	4000	80	44219999
<b>Magnetic Catches</b>								
	13142	13142	M72/GP2, 4 kg holding force, Brown	1	Pc	50	55	85051100

# Connecting Fittings

► Euro Adjustable Legs, Blue Max Mini Machine & Locks







Product	Article No.	SAP	Item Description	Qty.	Unit	PU	MRP	HS Code	
	<b>Euro Adjustable Legs</b>								
	40438	40438	Base Adjustable Stop 60-80 A	1	Pc	100	506	39263000	
	71840	9028440	Euro-Base Adjustable 100 mm	1	Pc	100	67	39263000	
	71841	9054653	Euro-Base Adjustable 130 mm	1	Pc	100	79	39263000	
	71842	9300596	Euro-Base Adjustable 150 mm	1	Pc	100	68	39263000	
	71847	9056095	Euro-PC Fixing Block Screw-On.	1	Pc	100	47	39263000	
	71845	9138216	Euro-PC Clips Screw-On	100	Pc	100	1,000	39263000	
	9020484	9020484	Euro-Base Plinth Plate Screw-On Self Colour	100	Pc	100	460	39263000	
	<b>Blue Max Mini Machine</b>								
	20264	9238684	Blue Max Mini T2/6 230V 50 HZ 1 PH	1	Pc	1	71,720	84651010	
	20485	20485	Fence Extension with Scale	1	Set	1	3,610	84669200	
	20486	20486	Holder For Fence Extension	1	Set	1	2,430	84669200	
	20487	20487	Set Of Fixed Stop	1	Set	1	950	84669200	
	20488	20488	Pendulum Stop For Fence- 61265	2	Set	2	1,620	84669200	
	20490	20490	Set Of Drill Bits For Hinges	1	Set	1	5,400	82075060	
	20492	20492	Set Of Drill Bits For VB 18/19/20/21	2	Set	2	8,880	82075060	
	20498	20498	Drill Bit D. 5 mm Left Hand	2	Pc	2	1,640	82075060	
	20499	20499	Drill Bit D. 2 mm Left Hand	2	Pc	2	2,640	82075060	
	9242840		Total				98,890		
	<b>Locks</b>								
	43635	43635	Multi-Purpose Square Lock 22mm - 200 KC	1	Set	100	241	83013000	
	9110389	9110389	Multi-Purpose Square Lock 32mm - 200 KC	1	Set	100	278	83013000	
	9246395	9246395	Multi-Purpose Square Lock 22mm - 400 KC with Foldable & Master key	1	Set	100	278	83013000	
	9259400	9259400	Multi-drawer Pedestal Lock 22 mm - 200 KC	1	Set	100	201	83013000	
	9289652	9289652	Multi-drawer Pedestal Lock 22 mm - 400 KC with Foldable Key and Master Key	1	Set	200	226	83013000	
	9259415	9259415	MD Lock Accessories & Rod	1	Set	100	204	83016000	
30125	30125	Stop bracket Type-3011 (For Multi Purpose Locks)	10	Pc	100	460	83024200		
	<b>Push Lock</b>								
	9180613	9180613	Push-Lock 22mm 200 KC with Master Key	1	Set	200	213	83013000	
9182732	9182732	Push-Lock 32mm 200 KC with Master Key	1	Set	200	226	83013000		
	<b>Numeric Lock</b>								
	930123400	930123400	Numerical Lock - Left/908L	1	Set	200	705	83013000	
	930123401	930123401	Numerical Lock - Left/908L with Master Key	1	Set	200	705	83013000	
	930123500	930123500	Numerical Lock - Right/908R	1	Set	200	705	83013000	
	930123501	930123501	Numerical Lock - Right/908R with Master Key	1	Set	200	705	83013000	
	930123502	930123502	Numerical Lock - Right/908R with Master Key & Accessories	1	Set	200	705	83013000	
			Note:						
			► Order model no. 908L for using on right side of cabinet						
			► Order model no. 908R for using on left side of cabinet						

# Connecting Fittings

## ► Locks



Product	Article No.	SAP	Item Description	Qty.	Unit	PU	MRP	HS Code
	<b>Espagnolette Cabinet Lock For 20 mm Doors Upto 8 ft</b>							
	9136128	9136128	Prestige 2000 Set Z23 Dia 18 mm - 20 mm	1	Set	10	1,455	83013000
	72251	72251	Espagnolette rod 1000 mm length	1	Set	10	232	83013000
	72253	72253	Espagnolette rod 1500 mm length	1	Set	10	352	83013000
	9078861	9078861	Lock Barrel+Keys Z23 18001-18050	1	Set	10	577	83013000
			Total				2,616	
	<b>Espagnolette Cabinet Lock For 26 mm Doors Upto 8 ft</b>							
	9154261	9154261	Prestige 2000 Set Z23 Dia 18 mm - 26 mm	1	Set	10	1,497	83013000
	72251	72251	Espagnolette rod 1000 mm length	1	Set	10	232	83013000
	72253	72253	Espagnolette rod 1500 mm length	1	Set	10	352	83013000
	9078861	9078861	Lock Barrel+Keys Z23 18001-18050	1	Set	10	577	83013000
			Total				2,658	
	<b>Cylinder Lock Set for 3-Door Sliding-Door Cabinets (Max Door Width=1200 mm; Thickness 20-22 mm)</b>							
	9133927	9133927	3 Door Sliding Lock Set Z23 Dia 18 mm	1	Set	10	2,850	83013000
	9078861	9078861	Lock Barrel+Keys Z23 18001-18050	1	Set	10	577	83013000
			Total				3,427	
	<b>Cylinder Lock Set for 2-Door Sliding-Door Cabinets (Max Door Width=1500 mm; Thickness 20-28 mm)</b>							
	9133926	9133926	2 Door Sliding Lock Set Z23 Dia 18 mm	1	Set	10	2,000	83013000
	9078861	9078861	Lock Barrel+Keys Z23 18001-18050	1	Set	10	577	83013000
			Total				2,577	
	<b>Automatic Door Bolt Nickel</b>							
	48259	48259	Automatic Door Bolt Nickel	1	Pc	10	920	83013000



Parma

Clivia

Lamezia

## Furniture Handles

Looks good. Feels good.

As a design element, a furniture handle plays an important part in a room. With little effort, a handle can be used to take a trend to any piece of furniture and provide a powerful impact.

The handle collection from Hettich makes it easy to individualise furniture in line with the latest trends. It offers innovative and trendy design variety for your furniture design - across all furniture segments.

IT'S ALL IN HETTICH.











  
**Hettich**



# Handles

► Econ Handles / ProDecore Handles





Product	Article No.	SAP	Hole Distance	Finish	Qty.	Unit	PU	MRP	HS Code
<b>Econ Handle</b>									
Adonia 	1180122	1180122	96	Nickel Matt	1	Pc	200	80	83024200
	1180121	1180121	128	Nickel Matt	1	Pc	150	126	83024200
Alano 	1180167	1180167	96	Nickel Matt	1	Pc	200	96	83024200
	1180166	1180166	128	Nickel Matt	1	Pc	125	133	83024200
Agacia 	9220976	9220976	96	Nickel Matt	1	Pc	50	93	83024200
Agacia 	9220975	9220975	96	Bright Chrome	1	Pc	50	84	83024200
	9220977	9220977	128	Bright Chrome	1	Pc	50	134	83024200
<b>ProDecore Handles</b>									
Baldone 	9995780	1161398	160	Bright Chrome	1	Pc	30	273	83024200
Evisa 	9113501	9113501	128	Bright Chrome	1	Pc	30	293	83024200
Salona 	1170155	1170155	160	Stainless steel	1	Pc	30	390	83024200
Clivia 	115353	9125415	160	Anodised Aluminum	1	Pc	50	1,369	83024200
Parma 	9113468	9113468	128	Bright Chrome	1	Pc	50	475	83024200
Messina 	115156	9211116	32	Brushed Stainless Steel	1	Pc	50	310	83024200

# Handles

## ► ProDecor Handles



Product	Article No.	SAP	Hole Distance	Finish	Qty.	Unit	PU	MRP	HS Code
Lamezia 	9248726	9248726	145	Stainless steel	1	Pc	25	344	83024200
	9248727	9248727	195	Stainless steel	1	Pc	25	428	83024200
	9105815	9105815	295	Stainless steel	1	Pc	25	1,243	83024200
	9105816	9105816	345	Stainless steel	1	Pc	25	1,302	83024200
	9105819	9105819	395	Stainless steel	1	Pc	5	1,448	83024200
	9105820	9105820	445	Stainless steel	1	Pc	5	1,536	83024200
	9105821	9105821	495	Stainless steel	1	Pc	5	1,770	83024200
	9105822	9105822	595	Stainless steel	1	Pc	5	1,974	83024200
	9105823	9105823	795	Stainless steel	1	Pc	25	2,502	83024200
	9105824	9105824	895	Stainless steel	1	Pc	5	2,910	83024200
	9105825	9105825	995	Stainless steel	1	Pc	25	1,957	83024200
	9105826	9105826	1195	Stainless steel	1	Pc	25	2,139	83024200
Lamezia 	9247829	9247829	145	Anodised Aluminum	1	Pc	25	314	83024200
	9247830	9247830	195	Anodised Aluminum	1	Pc	25	392	83024200
	9105827	9105827	295	Anodised Aluminum	1	Pc	25	893	83024200
	9105828	9105828	345	Anodised Aluminum	1	Pc	25	951	83024200
	9105829	9105829	395	Anodised Aluminum	1	Pc	25	1,097	83024200
	9105830	9105830	445	Anodised Aluminum	1	Pc	25	738	83024200
	9105831	9105831	495	Anodised Aluminum	1	Pc	25	1,419	83024200
	9105832	9105832	595	Anodised Aluminum	1	Pc	25	992	83024200
	9105833	9105833	795	Anodised Aluminum	1	Pc	25	1,320	83024200
	9105834	9105834	895	Anodised Aluminum	1	Pc	25	2,530	83024200
	9105835	9105835	995	Anodised Aluminum	1	Pc	25	1,721	83024200
	9105836	9105836	1195	Anodised Aluminum	1	Pc	25	1,866	83024200



Bottom Cabinets



Mid Way Joining Profile



Profile Handles

## Aluminium Profiles

For a seamless and elegant furniture look

Light weight and multipurpose; Hettich Aluminium Profiles are extremely versatile furniture fitting elements. Depending upon the purpose, one can use them in kitchen, living room, bedroom etc. to create elements that enhance the appearance of one's furniture.

IT'S ALL IN HETTICH.



# Imported Aluminium Profiles

► 19 mm / 45 mm / 55 mm Aluminium Profiles



Product	Product Section	Glass Thickness	Width	Finish	Article No.	SAP	Unit	PU	MRP	HS Code
19 mm Straight Frame Profile 3000 mm		4 mm	19 mm	MB	9348526	9348526	Pc	8	1,990	76042990
				Ch	9348527	9348527	Pc	8	1,990	76042990
				SS	9348528	9348528	Pc	8	1,990	76042990
				Grey	9348529	9348529	Pc	8	1,990	76042990
				Copper	9348530	9348530	Pc	8	1,990	76042990
				BC	9348531	9348531	Pc	8	2,190	76042990
				Rose	9348532	9348532	Pc	8	2,190	76042990
				Golden	9348533	9348533	Pc	8	2,190	76042990
19 mm Straight Frame Profile with handle 3000 mm		4 mm	19 mm	MB	9348535	9348535	Pc	8	2,490	76042990
				Ch	9348536	9348536	Pc	8	2,490	76042990
				SS	9348537	9348537	Pc	8	2,490	76042990
				Grey	9348538	9348538	Pc	8	2,490	76042990
				Copper	9348539	9348539	Pc	8	2,490	76042990
				BC	9348540	9348540	Pc	8	2,590	76042990
				Rose	9348541	9348541	Pc	8	2,590	76042990
				Golden	9348542	9348542	Pc	8	2,590	76042990
45 mm Straight Frame Profile 3000 mm		4 mm	45 mm	MB	9345502	9345502	Pc	4	3,150	76042990
				Ch	9345503	9345503	Pc	4	3,150	76042990
				SS	9345505	9345505	Pc	4	3,150	76042990
				Grey	9345506	9345506	Pc	4	3,150	76042990
				Copper	9345507	9345507	Pc	4	3,150	76042990
				BC	9345508	9345508	Pc	4	3,900	76042990
				Rose	9345510	9345510	Pc	4	3,900	76042990
				Golden	9345511	9345511	Pc	4	3,900	76042990
45 mm Straight Frame Profile with F Handle 3000 mm		4 mm	45 mm	MB	9345512	9345512	Pc	4	3,850	76042990
				Ch	9345516	9345516	Pc	4	3,850	76042990
				SS	9345517	9345517	Pc	4	3,850	76042990
				Grey	9345518	9345518	Pc	4	3,850	76042990
				Copper	9345519	9345519	Pc	4	3,850	76042990
				BC	9345521	9345521	Pc	4	4,750	76042990
				Rose	9345522	9345522	Pc	4	4,750	76042990
				Golden	9345523	9345523	Pc	4	4,750	76042990
45 mm Straight Frame Profile with I Handle 3000 mm		4 mm	45 mm	MB	9348544	9348544	Pc	4	3,690	76042990
				Ch	9348545	9348545	Pc	4	3,690	76042990
				SS	9348546	9348546	Pc	4	3,690	76042990
				Grey	9348547	9348547	Pc	4	3,690	76042990
				Copper	9348548	9348548	Pc	4	3,690	76042990
				BC	9348549	9348549	Pc	4	3,990	76042990
				Rose	9348550	9348550	Pc	4	3,990	76042990
				Golden	9348551	9348551	Pc	4	3,990	76042990
55 mm Straight Frame Profile 3000 mm		4 mm	55 mm	MB	9345456	9345456	Pc	4	3,550	76042990
				Ch	9345457	9345457	Pc	4	3,550	76042990
				SS	9345458	9345458	Pc	4	3,550	76042990
				Grey	9345459	9345459	Pc	4	3,550	76042990
				Copper	9345460	9345460	Pc	4	3,550	76042990
				BC	9345491	9345491	Pc	4	4,450	76042990
				Rose	9345492	9345492	Pc	4	4,450	76042990
				Golden	9345493	9345493	Pc	4	4,450	76042990

# Imported Aluminium Profiles

► 55 mm / Mid Way / Gola / Vertical Gola Profiles



Product	Product Section	Glass Thickness	Width	Finish	Article No.	SAP	Unit	PU	MRP	HS Code
55 mm Straight Frame Profile with C Handle 3000 mm		4 mm	55 mm	MB	9345494	9345494	Pc	4	4,450	76042990
				Ch	9345495	9345495	Pc	4	4,450	76042990
				SS	9345496	9345496	Pc	4	4,450	76042990
				Grey	9345497	9345497	Pc	4	4,450	76042990
				Copper	9345498	9345498	Pc	4	4,450	76042990
				BC	9345499	9345499	Pc	4	5,500	76042990
				Rose	9345500	9345500	Pc	4	5,500	76042990
				Golden	9345501	9345501	Pc	4	5,500	76042990
Mid Way Joining Profile 3000 mm		4/5 mm	16 mm	MB	9345486	9345486	Pc	8	1,650	76042990
				Ch	9345487	9345487	Pc	8	1,650	76042990
				SS	9345488	9345488	Pc	8	1,650	76042990
				Grey	9345489	9345489	Pc	8	1,650	76042990
				Copper	9345490	9345490	Pc	8	1,650	76042990
				BC	9345611	9345611	Pc	8	2,000	76042990
				Rose	9345612	9345612	Pc	8	2,000	76042990
				Golden	9345613	9345613	Pc	8	2,000	76042990
Gola Profile C Type 3000 mm				MB	9345614	9345614	Pc	4	2,450	76042990
				Ch	9345615	9345615	Pc	4	2,450	76042990
				SS	9345616	9345616	Pc	4	2,450	76042990
				Grey	9345617	9345617	Pc	4	2,450	76042990
				Copper	9345618	9345618	Pc	4	2,450	76042990
				BC	9345619	9345619	Pc	4	3,000	76042990
				Rose	9345620	9345620	Pc	4	3,000	76042990
				Golden	9345621	9345621	Pc	4	3,000	76042990
Gola Profile L Type 3000 mm				MB	9345622	9345622	Pc	4	1,950	76042990
				Ch	9345623	9345623	Pc	4	1,950	76042990
				SS	9345624	9345624	Pc	4	1,950	76042990
				Grey	9345625	9345625	Pc	4	1,950	76042990
				Copper	9345626	9345626	Pc	4	1,950	76042990
				BC	9345627	9345627	Pc	4	2,400	76042990
				Rose	9345628	9345628	Pc	4	2,400	76042990
				Golden	9345629	9345629	Pc	4	2,400	76042990
Vertical Gola Profile C Type 3000 mm	<p>Double side C Profile</p>			MB	9345878	9345878	Pc	4	4,150	76042990
				Ch	9345879	9345879	Pc	4	4,150	76042990
				SS	9345880	9345880	Pc	4	4,150	76042990
				Grey	9345881	9345881	Pc	4	4,150	76042990
				Copper	9345882	9345882	Pc	4	4,150	76042990
				BC	9345883	9345883	Pc	4	4,850	76042990
				Rose	9345884	9345884	Pc	4	4,850	76042990
				Golden	9345885	9345885	Pc	4	4,850	76042990
Vertical Gola Profile L Type 3000 mm	<p>Single side L Profile</p>			MB	9345858	9345858	Pc	4	3,650	76042990
				Ch	9345859	9345859	Pc	4	3,650	76042990
				SS	9345860	9345860	Pc	4	3,650	76042990
				Grey	9345871	9345871	Pc	4	3,650	76042990
				Copper	9345872	9345872	Pc	4	3,650	76042990
				BC	9345874	9345874	Pc	4	4,400	76042990
				Rose	9345875	9345875	Pc	4	4,400	76042990
				Golden	9345876	9345876	Pc	4	4,400	76042990



# Imported Aluminium Profiles

## ► Edge / Eslinga Econ G / Sliding Wardrobe Profile





Product	Product Section	Glass Thickness	Width	Finish	Article No.	SAP	Unit	PU	MRP	HS Code
Edge Profile for Wall Cabinet 3000 mm				MB	9345630	9345630	Pc	8	2,300	76042990
				Ch	9345631	9345631	Pc	8	2,300	76042990
				SS	9345632	9345632	Pc	8	2,300	76042990
				Grey	9345633	9345633	Pc	8	2,300	76042990
				Copper	9345634	9345634	Pc	8	2,300	76042990
				BC	9345635	9345635	Pc	8	2,800	76042990
				Rose	9345636	9345636	Pc	8	2,800	76042990
				Golden	9345637	9345637	Pc	8	2,800	76042990
Eslinga Econ G Profile 3000 mm				MB	9345751	9345751	Pc	4	4,000	76042990
				Ch	9345752	9345752	Pc	4	4,000	76042990
				SS	9345753	9345753	Pc	4	4,000	76042990
				Grey	9345754	9345754	Pc	4	4,000	76042990
				Copper	9345853	9345853	Pc	4	4,000	76042990
				BC	9345854	9345854	Pc	4	4,700	76042990
				Rose	9345855	9345855	Pc	4	4,700	76042990
				Golden	9345856	9345856	Pc	4	4,700	76042990
Handle Profile 3000 mm				MB	9345638	9345638	Pc	8	2,350	76042990
				Ch	9345639	9345639	Pc	8	2,350	76042990
				SS	9345640	9345640	Pc	8	2,350	76042990
				Grey	9345641	9345641	Pc	8	2,350	76042990
				Copper	9345642	9345642	Pc	8	2,350	76042990
				BC	9345643	9345643	Pc	8	2,900	76042990
				Rose	9345644	9345644	Pc	8	2,900	76042990
				Golden	9345645	9345645	Pc	8	2,900	76042990
Partition Profile 3000 mm				MB	9345646	9345646	Pc	8	1,350	76042990
				Ch	9345647	9345647	Pc	8	1,350	76042990
				SS	9345648	9345648	Pc	8	1,350	76042990
				Grey	9345649	9345649	Pc	8	1,350	76042990
				Copper	9345650	9345650	Pc	8	1,350	76042990
				BC	9345651	9345651	Pc	8	1,600	76042990
				Rose	9345652	9345652	Pc	8	1,600	76042990
				Golden	9345653	9345653	Pc	8	1,600	76042990
Straight Profile 3000 mm				MB	9345654	9345654	Pc	8	1,500	76042990
				Ch	9345655	9345655	Pc	8	1,500	76042990
				SS	9345656	9345656	Pc	8	1,500	76042990
				Grey	9345657	9345657	Pc	8	1,500	76042990
				Copper	9345658	9345658	Pc	8	1,500	76042990
				BC	9345659	9345659	Pc	8	1,800	76042990
				Rose	9345660	9345660	Pc	8	1,800	76042990
				Golden	9345741	9345741	Pc	8	1,800	76042990
Wardrobe Profile 3000 mm				MB	9345742	9345742	Pc	8	2,850	76042990
				Ch	9345743	9345743	Pc	8	2,850	76042990
				SS	9345744	9345744	Pc	8	2,850	76042990
				Grey	9345745	9345745	Pc	8	2,850	76042990
				Copper	9345746	9345746	Pc	8	2,850	76042990
				BC	9345747	9345747	Pc	8	3,500	76042990
				Rose	9345748	9345748	Pc	8	3,500	76042990
				Golden	9345749	9345749	Pc	8	3,500	76042990

# Imported Aluminium Profiles

## ► Connector Set







Product	Product Section		Article No.	SAP	Unit	PU	MRP	HS Code
Angle Connector Set (For all aluminum profiles)		1 Set Consists of 4 connectors & 8 screws	9303247	9303247	Set	30	142	83024200
Connector Set for Mid Way Joining Profile			9308603	9308603	Pc	10	106	76042990



# Imported Aluminium Profiles

## ► Gola Profile Accessories



Item Description	Product	Compatible with	Side	Article No.	SAP	Unit	PU	MRP	HS Code
<b>Gola Profile Accessories</b>									
Gola Profile End Cap for C Type with screws		SS Et BC	Left	9218244	9218244	Pc	20	278	83024200
			Right	9218245	9218245	Pc	20	278	83024200
		MB	Left	9299044	9299044	Pc	20	305	79070090
			Right	9299045	9299045	Pc	20	305	79070090
		Rose	Left	9310754	9310754	Pc	20	305	83024200
			Right	9310755	9310755	Pc	20	305	83024200
		Ch	Left	9310760	9310760	Pc	20	305	83024200
			Right	9310761	9310761	Pc	20	305	83024200
		Copper	Left	9348554	9348554	Pc	20	305	76042990
			Right	9348555	9348555	Pc	20	305	76042990
		Grey	Left	9348560	9348560	Pc	20	305	76042990
			Right	9348561	9348561	Pc	20	305	76042990
		Golden	Left	9348566	9348566	Pc	20	305	76042990
			Right	9348567	9348567	Pc	20	305	76042990
Gola Profile End Cap for L Type with screws		SS Et BC	Left	9218246	9218246	Pc	20	278	83024200
			Right	9218247	9218247	Pc	20	278	83024200
		MB	Left	9299042	9299042	Pc	20	305	79070090
			Right	9299043	9299043	Pc	20	305	79070090
		Rose	Left	9310756	9310756	Pc	20	305	83024200
			Right	9310757	9310757	Pc	20	305	83024200
		Ch	Left	9310762	9310762	Pc	20	305	83024200
			Right	9310763	9310763	Pc	20	305	83024200
		Copper	Left	9348552	9348552	Pc	20	305	76042990
			Right	9348553	9348553	Pc	20	305	76042990
		Grey	Left	9348558	9348558	Pc	20	305	76042990
			Right	9348559	9348559	Pc	20	305	76042990
		Golden	Left	9348564	9348564	Pc	20	305	76042990
			Right	9348565	9348565	Pc	20	305	76042990
Gola Outer Angle Profile Connector with screws		SS Et BC		9218248	9218248	Pc	20	331	83024200
		MB		9299046	9299046	Pc	20	328	79070090
		Rose		9310758	9310758	Pc	20	362	83024200
		Ch		9310764	9310764	Pc	20	362	83024200
		Copper		9348556	9348556	Pc	20	362	76042990
		Grey		9348562	9348562	Pc	20	362	76042990
		Golden		9348568	9348568	Pc	20	362	76042990
Gola Inner Angle Profile Connector with screws		SS Et BC		9218269	9218269	Pc	20	484	83024200
		MB		9299047	9299047	Pc	20	474	79070090
		Rose		9310759	9310759	Pc	20	505	83024200
		Ch		9310765	9310765	Pc	20	505	83024200
		Copper		9348557	9348557	Pc	20	505	76042990
		Grey		9348563	9348563	Pc	20	505	76042990
		Golden		9348569	9348569	Pc	20	505	76042990
Gola L Connector set with screws				9333566	9333566	Pc	50	46	83024200

# Aluminium Profiles

## ▶ 19 mm / 45 mm Aluminium Profiles



Product	Product Section	Glass Thickness	Width	Finish	Article No.	SAP	Unit	PU	MRP	HS Code
19 mm Straight Frame Profile 3000 mm		4 mm	19 mm	SA	9288843	9288843	Pc	4	1,386	76042990
				SS	9307821	9307821	Pc	4	1,890	76042990
				BL	9307822	9307822	Pc	4	1,890	76042990
				CP	9307823*	9307823*	Pc	4	2,110	76042990
				DC	9310257	9310257	Pc	4	1,890	76042990
19 mm Straight Frame Profile with handle 3000 mm		4 mm	19 mm	SA	9283472	9283472	Pc	4	1,764	76042990
				SS	9307824	9307824	Pc	4	2,400	76042990
				BL	9307825	9307825	Pc	4	2,400	76042990
				CP	9307826*	9307826*	Pc	4	2,690	76042990
				DC	9310258	9310258	Pc	4	2,400	76042990
45 mm Straight Frame Profile 3000 mm		4 mm	45 mm	SA	9283473	9283473	Pc	4	2,783	76042990
				SS	9307827	9307827	Pc	4	3,800	76042990
				BL	9307828	9307828	Pc	4	3,800	76042990
				CP	9307829*	9307829*	Pc	4	4,240	76042990
				DC	9310254	9310254	Pc	4	3,800	76042990
45 mm Straight Frame Profile with L Handle 3000 mm		4 mm	45 mm	SA	9283485	9283485	Pc	4	3,633	76042990
				SS	9307830	9307830	Pc	4	4,950	76042990
				BL	9307847	9307847	Pc	4	4,950	76042990
				CP	9307848*	9307848*	Pc	4	4,950	76042990
				DC	9310256	9310256	Pc	4	4,950	76042990
45 mm Straight Frame Profile with C Handle 3000 mm		4 mm	55 mm	SA	9283474	9283474	Pc	4	3,455	76042990
45 mm Straight Frame Profile with F Handle 3000 mm		4 mm	45 mm	SA	9283494	9283494	Pc	4	3,350	76042990
				SS	9307849	9307849	Pc	4	4,370	76042990
				BL	9307851	9307851	Pc	4	4,370	76042990
				CP	9307852*	9307852*	Pc	4	4,880	76042990
				DC	9322379	9322379	Pc	4	4,370	76042990
45mm Straight Frame Profile 3000 mm		6 mm	45 mm	SA	9283490	9283490	Pc	4	2,321	76042990
45 mm Straight Frame Profile with L Handle 3000 mm		6 mm	45 mm	SA	9283493	9283493	Pc	4	3,119	76042990

● SA - Silver finish ● SS - Stainless steel finish ● BL - Black finish ● DC - Dark Champagne Finish

# Aluminium Profiles

## ► 45 mm / 55 mm Aluminium Profiles



Product	Product Section	Glass Thickness	Width	Finish	Article No.	SAP	Unit	PU	MRP	HS Code
45 mm Straight Stick-On Frame Profile 3000 mm		4 mm	45 mm	SA	9283488	9283488	Pc	4	2,247	76042990
				SS	9302252	9302252	Pc	4	3,060	76042990
				BL	9302253	9302253	Pc	4	3,060	76042990
				CP	9302254*	9302254*	Pc	4	3,420	76042990
45 mm Straight Stick-On Frame Profile with L handle 3000 mm		4 mm	45 mm	SA	9283487	9283487	Pc	4	3,045	76042990
				SS	9302229	9302229	Pc	4	4,150	76042990
				BL	9302230	9302230	Pc	4	4,150	76042990
				CP	9302251*	9302251*	Pc	4	4,630	76042990
45 mm Straight Frameless Stick on Profile 3000 mm		4 mm	45 mm	SA	9306110	9306110	Pc	4	2,279	76042990
				SS	9306161	9306161	Pc	4	3,100	76042990
				BL	9306163	9306163	Pc	4	3,100	76042990
				CP	9306162*	9306162*	Pc	4	3,460	76042990
45 mm Straight Frameless Stick on Handle Profile 3000 mm		4 mm	45 mm	SA	9306164	9306164	Pc	4	2,909	76042990
				SS	9306165	9306165	Pc	4	3,960	76042990
				BL	9306167	9306167	Pc	4	3,960	76042990
				CP	9306166*	9306166*	Pc	4	4,420	76042990
55 mm Straight Frame Profile 3000 mm		4 mm	55 mm	SA	9288842	9288842	Pc	4	2,783	76042990
				SS	9307853	9307853	Pc	4	3,800	76042990
				BL	9307854	9307854	Pc	4	3,800	76042990
				CP	9307855*	9307855*	Pc	4	4,240	76042990
				DC	9310252	9310252	Pc	4	3,800	9310252
55 mm Straight Frame Profile with C Handle 3000 mm		4 mm	55 mm	SA	9288844	9288844	Pc	4	3,434	76042990
				SS	9307856	9307856	Pc	4	4,680	76042990
				BL	9307857	9307857	Pc	4	4,680	76042990
				CP	9307858*	9307858*	Pc	4	5,230	76042990
				DC	9310253	9310253	Pc	4	4,680	76042990
55 mm Curved Frame Profile 3000 mm		4 / 5 mm	55 mm	SA	9288848	9288848	Pc	4	3,402	76042990
55 mm Curved Frame Profile 3000 mm with Handle		4 / 5 mm	55 mm	SA	9283471	9283471	Pc	4	4,845	76042990



● SA - Silver finish ● SS - Stainless steel finish ● BL - Black finish ● DC - Dark Champagne Finish



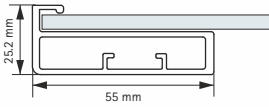
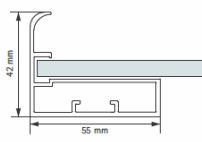

# Aluminium Profiles

- ▶ 55 mm Aluminium Profiles
- ▶ Edge / Mid Way Profile

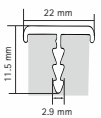
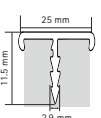
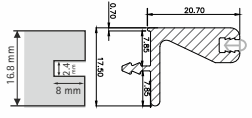
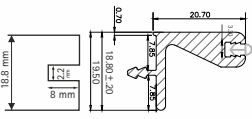
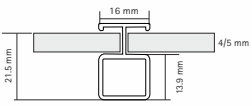

Product	Product Section	Glass Thickness	Width	Finish	Article No.	SAP	Unit	PU	MRP	HS Code
55 mm Straight Frame Profile 3000 mm		8 mm	55 mm	SA	9283491	9283491	Pc	4	2,636	76042990
				SS	9340558	9340558	Pc	4	3,430	76042990
				BL	9340557	9340557	Pc	4	3,430	76042990
				DC	9340559	9340559	Pc	4	3,430	76042990
55 mm Straight Frame Profile with F Handle 3000 mm		8 mm	55 mm	SA	9283495	9283495	Pc	4	3,255	76042990
				SS	9340571	9340571	Pc	4	4,230	76042990
				BL	9340560	9340560	Pc	4	4,230	76042990
				DC	9340572	9340572	Pc	4	4,230	76042990
Angle Connector Set (For all aluminum profiles)		1 Set Consists of 4 connectors & 8 screws			9303247	9303247	Set	30	142	83024200

Item Description	Profile Section	Suitable for (mm)	Width (mm)	Finish	Article No.	SAP	Unit	PU	MRP	HS Code
<b>Edge Profile</b>										
Edge Profile (22 mm) 3000 mm		19 mm board thickness		SA	9283498	9283498	Pc	8	546	76042990
				SS	9299208	9299208	Pc	8	740	76042990
				BL	9307613	9307613	Pc	8	740	76042990
				CP	9302261*	9302261*	Pc	8	830	76042990
				DC	9310262	9310262	Pc	8	740	76042990
Edge Profile (25 mm) 3000 mm		22 mm board thickness		SA	9283500	9283500	Pc	8	609	76042990
				SS	9299209	9299209	Pc	8	830	76042990
				BL	9307614	9307614	Pc	8	830	76042990
				CP	9302262*	9302262*	Pc	8	930	76042990
				DC	9310263	9310263	Pc	8	830	76042990
Edge Profile for Wall cabinet 3000 mm		16.8 mm board thickness onwards	-	SA	9283517	9283517	Pc	12	1,754	76042990
				SS	9299223	9299223	Pc	12	2,390	76042990
				BL	9307859	9307859	Pc	12	2,390	76042990
				CP	9307860*	9307860*	Pc	12	2,670	76042990
				DC	9310267	9310267	Pc	12	2,390	76042990
Edge Profile for Wall cabinet 3000 mm		18.8 mm board thickness onwards	-	SA	9312136	9312136	Pc	12	1,827	76042990
				SS	9312247	9312247	Pc	12	2,490	76042990
				BL	9312249	9312249	Pc	12	2,490	76042990
				CP	9312248*	9312248*	Pc	12	2,790	76042990
				DC	9322380	9322380	Pc	12	2,490	76042990
Mid Way Joining profile 3000 mm		4 & 5 mm	16 mm	SA	9283496	9283496	Pc	8	1,313	76042990
				SS	9307861	9307861	Pc	8	1,680	76042990
				BL	9307862	9307862	Pc	8	1,680	76042990
				CP	9307863*	9307863*	Pc	8	1,880	76042990
				DC	9310261	9310261	Pc	8	1,680	76042990
Connector Set for Mid Way Joining Profile					9308603	9308603	Pc	10	106	76042990

● SA - Silver finish ● SS - Stainless steel finish ● BL - Black finish ● DC - Dark Champagne Finish

# Aluminium Profiles

- ▶ Gola Profile & Vertical Gola Profile
- ▶ Sink Counter Profile & Gola Profile Accessories





Product	Product Section	Length (mm)	Finish	Article No.	SAP	Unit	PU	MRP	HS Code		
<b>Gola Profile</b>											
Gola profile C Type		3000	SA	9283515	9283515	Pc	10	2,027	76042990		
			SS	9299221	9299221	Pc	10	2,510	76042990		
			BL	9299226	9299226	Pc	10	2,510	76042990		
			CP	9300522*	9300522*	Pc	10	3,090	76042990		
			DC	9310426	9310426	Pc	10	2,510	76042990		
Gola profile L Type		3000	SA	9283516	9283516	Pc	10	1,596	76042990		
			SS	9299222	9299222	Pc	10	1,990	76042990		
			BL	9299225	9299225	Pc	10	1,990	76042990		
			CP	9300521*	9300521*	Pc	10	2,400	76042990		
			DC	9310427	9310427	Pc	10	1,990	76042990		
<b>Vertical Gola Profile</b>											
Gola profile (Vertical application)		3000	SA	9293474	9293474	Pc	4	2,919	76042990		
			SS	9302257	9302257	Pc	4	3,980	76042990		
			BL	9300496	9300496	Pc	4	3,980	76042990		
			CP	9300524*	9300524*	Pc	4	4,440	76042990		
			DC	9310269	9310269	Pc	4	3,980	76042990		
Gola profile (Vertical application)		3000	SA	9293473	9293473	Pc	4	2,594	76042990		
			SS	9302256	9302256	Pc	4	3,530	76042990		
			BL	9300494	9300494	Pc	4	3,530	76042990		
			CP	9300523*	9300523*	Pc	4	3,940	76042990		
			DC	9310268	9310268	Pc	4	3,530	76042990		
Product	Product Section	Length (mm)	Finish	Article No.	SAP	Unit	PU	MRP	HS Code		
<b>Sink Counter Profile with Connectors</b>											
Sink counter profile		3000	SA	9293475	9293475	Pc	6	1,806	76042990		
Bracket for sink counter profile left		-	-	9293678	9293678	Pc	50	26	76042990		
Bracket for sink counter profile right		-	-	9293699	9293699	Pc	50	26	76042990		
Item Description	Product	Compatible with	Side	Article No.	SAP	Unit	PU	MRP	HS Code		
<b>Gola Profile Accessories</b>											
Gola Profile End Cap for C Type with screws		SA & CP	Left	9212563	9212563	Pc	20	277	76042990		
			Right	9212564	9212564	Pc	20	277	76042990		
		SS	Left	9218244	9218244	Pc	20	278	76042990		
			Right	9218245	9218245	Pc	20	278	76042990		
		BL	Left	9299044	9299044	Pc	20	305	76042990		
			Right	9299045	9299045	Pc	20	305	76042990		
		DC	Left	9310760	9310760	Pc	20	305	76042990		
			Right	9310761	9310761	Pc	20	305	76042990		
		Gola Profile End Cap for L Type with screws		SA & CP	Left	9212565	9212565	Pc	20	277	76042990
					Right	9212566	9212566	Pc	20	277	76042990
SS	Left			9218246	9218246	Pc	20	278	76042990		
	Right			9218247	9218247	Pc	20	278	76042990		
BL	Left			9299042	9299042	Pc	20	305	76042990		
	Right			9299043	9299043	Pc	20	305	76042990		
DC	Left			9310762	9310762	Pc	20	305	76042990		
	Right			9310763	9310763	Pc	20	305	76042990		

● SA - Silver finish ● SS - Stainless steel finish ● BL - Black finish ● DC - Dark Champagne Finish

# Aluminium Profiles

## ► Gola Profile Accessories



Item Description	Product	Compatible with	Side	Article No.	SAP	Unit	PU	MRP	HS Code
Gola Outer Angle Profile Connector with screws		SA & CP		9212567	9212567	Pc	20	331	76042990
		SS		9218248	9218248	Pc	20	331	76042990
		BL		9299046	9299046	Pc	20	328	76042990
		DC		9310764	9310764	Pc	20	362	76042990
Gola Inner Angle Profile Connector with screws		SA & CP		9212568	9212568	Pc	20	484	76042990
		SS		9218269	9218269	Pc	20	484	76042990
		BL		9299047	9299047	Pc	20	474	76042990
		DC		9310765	9310765	Pc	20	505	76042990
Gola L Connector set with screws		-		9333566	9333566	Pc	50	46	76042990



● SA - Silver finish ● SS - Stainless steel finish ● BL - Black finish ● DC - Dark Champagne Finish

# Aluminium Profiles

## ► Profile Handles



Product	Product Section	Details	Finish	Article No.	SAP	Unit	PU	MRP	HS Code
Handle Eslinga (G Profile) with End cap		Profile 35 mm (H) Et (L) 3000 mm	SA	9316534	9316534	Pc	4	2,835	76042990
			BL	9306108	9306108	Pc	4	3,880	76042990
		End cap	SA	9316535	9316535	Set	1	10	76042990
			BL	9306109	9306109	Set	1	10	76042990
Handle Eslinga (G Profile)		Profile height 40 mm Et Length 3000 mm	SA	9283502	9283502	Pc	4	3,728	76042990
			SS	9322411	9322411	Pc	4	4,980	76042990
			BL	9302228	9302228	Pc	4	4,980	76042990
			DC	9322412	9322412	Pc	4	4,980	76042990
Eslinga Econ (G Profile)		Profile height 35 mm Et Length 3000 mm	SA	9283503	9283503	Pc	4	2,877	76042990
			SS	9299210	9299210	Pc	4	3,930	76042990
			BL	9299224	9299224	Pc	4	3,930	76042990
			DC	9310266	9310266	Pc	4	3,930	76042990
Lutetia		Profile height 28 mm Et Length 3000 mm	SA	9133756	9133756	Pc	4	2,342	76042990
			SS	9322413	9322413	Pc	4	3,130	76042990
			BL	9322414	9322414	Pc	4	3,130	76042990
			DC	9310302	9310302	Pc	4	3,130	76042990
Calisia		Length 1950 mm	SA	9125763	9125763	Pc	8	2,090	76042990
Lindavia		For 19 mm board Et Length 2000 mm	SA	9125832	9125832	Pc	12	1,355	94039000
Ticinum		Length 2000 mm	SA	9131455	9131455	Pc	12	1,565	76042990
Seveso		Profile height 38mm for 19 mm thickness Et Length 2400 mm	SA	1161200	1161200	Pc	6	1,491	76042990
			SS	9333370	9333370	Pc	6	1,890	76042990
			BL	9333371	9333371	Pc	6	1,890	76042990
			DC	9333372	9333372	Pc	6	1,890	76042990
Seveso		Profile height 38 mm for 17 mm thickness Et Length 3000 mm	SA	1161199	1161199	Pc	6	1,910	76042990
			SS	9338908	9338908	Pc	6	1,815	76042990
			BL	9338906	9338906	Pc	6	1,815	76042990
			DC	9338907	9338907	Pc	6	1,815	76042990

● SA - Silver finish ● SS - Stainless steel finish ● BL - Black finish ● DC - Dark Champagne Finish



Bedroom

Bathroom

Kitchen

## Shelving Systems

Create infinite design possibilities

Hettich's Shelving Systems are an advanced shelving system that enables one to create infinite design possibilities for different spaces. It is versatile, contemporary and easy to install. When installed on a wall, it does not look any less than a modern piece of art.

IT'S ALL IN HETTICH.







# Shelving System: Cube PLUS

► Profiles, Connectors & Accessories



Product	Article No.	SAP	Item Description	Finish	Qty.	Unit	PU	MRP	HS Code
<b>Profiles</b>									
	9307899	9307899	Basic Profile (3000 mm length)	Black Finish	1	Pc	4	1,864	76042100
	9321241	9321241	Wood Profile for 18 mm panels (3000 mm length)	Black Finish	1	Pc	4	1,864	76042100
	9321243	9321243	Glass/Wood Profile for 6/10 mm panels (3000 mm length)	Black Finish	1	Pc	4	1,864	76042100
<b>Connectors</b>									
	9307882	9307882	Double connector 2 way	Black Finish	1	Pc	1	249	83024200
	9307884	9307884	Triple 2D connector 3 way	Black Finish	1	Pc	1	249	83024200
	9307886	9307886	Triple 3D Connector 3 Way	Black Finish	1	Pc	1	249	83024200
	9307888	9307888	Quadruple Connector 4 Way	Black Finish	1	Pc	1	249	83024200
	9307890	9307890	Quintuple connector 5 way	Black Finish	1	Pc	1	249	83024200
<b>Accessories</b>									
	9307892	9307892	Fixing Screw M4x16mm Steel	Black Finish	1	Pc	200	5	73181558
	9307893	9307893	Cover Cap for M4 Screw	Black Finish	1	Pc	200	2	39263000
	9319027	9319027	Set of wall mounting, pan head screw and wall plug	-	1	Set	1	116	83024200
	9314947	9314947	Support (Buffer) for glass shelf 6 mm dia stick on	Translucent	5	Pc	5	10	39269097
	9298658	9298658	Self Adhesive Felt Pads	-	1	Pc	1	90	56021019

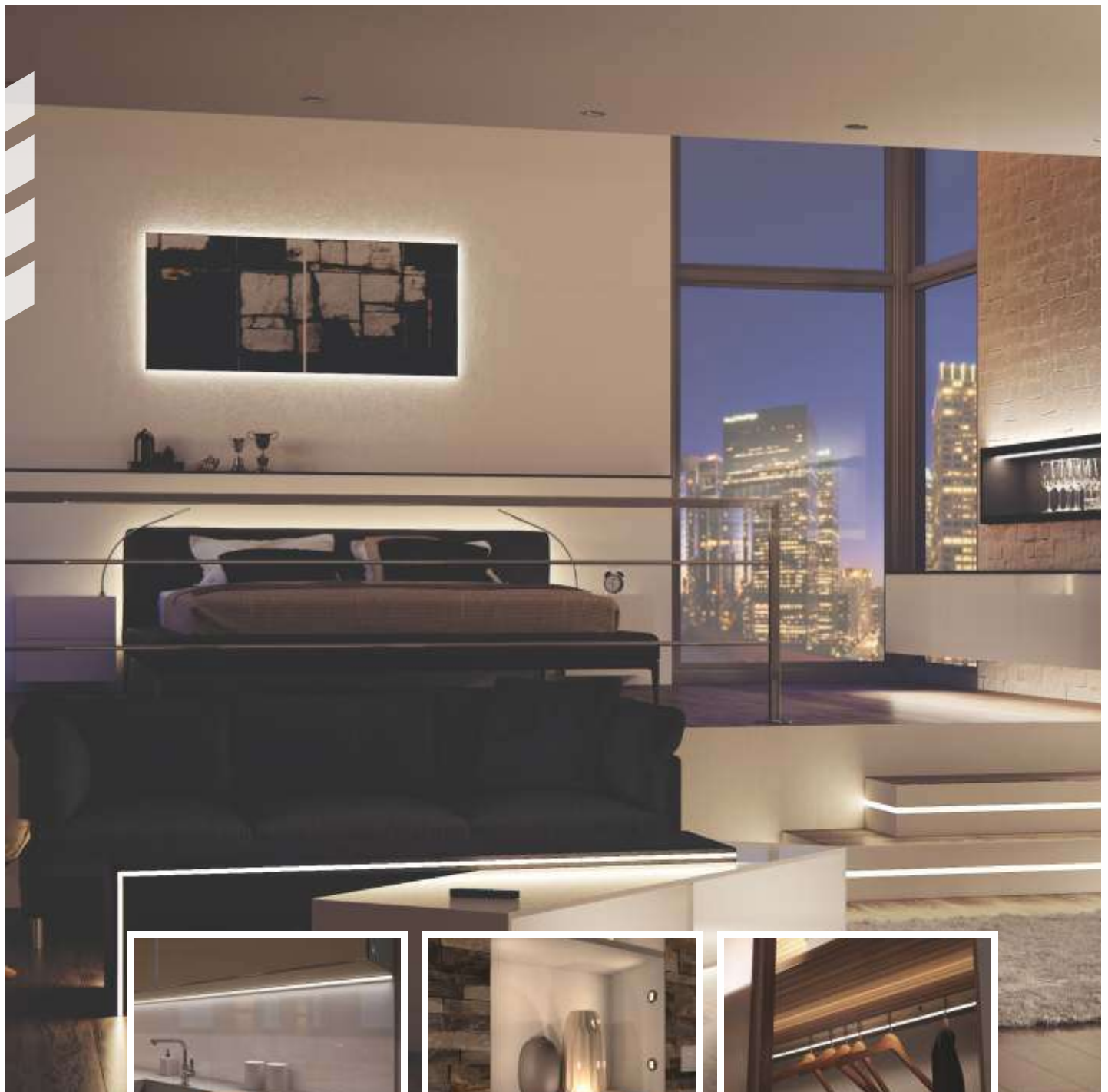

Linear Lights

Spot Lights

Special Lights

## Furniture Lights





Your furniture in the very best light

Hettich brings to you a new range of furniture lights called 'Magic Lights' to elevate your spaces. Made with cutting-edge German technology, the range includes spot lights, linear lights & special lights designed for kitchens, wardrobes, and every corner of your home. These lights also come with sensor options & are BIS certified with a minimum operational lifespan of 40,000 hours.

IT'S ALL IN HETTICH.



**magic** Lights

Product	Article No.	SAP	Item Description	Qty.	Unit	PU	MRP	HS Code
<b>Lights</b>								
	<b>Linear Lights</b>							
	9335232	9335232	Versa Inside 80, 12VDC WW, L=5m, 4.8W/m, Lead 2x1.8m	1	Pc	1	7,450	94054231
	9335231	9335231	Versa Inside 80, 12VDC NW, L=5m, 4.8W/m, Lead 2x1.8m1	1	Pc	1	5,450	94054231
	9335234	9335234	Versa Inside 120, 12VDC WW, L=5m, 7.2W/m, Lead 2x1.8m	1	Pc	1	7,000	94054231
	9335233	9335233	Versa Inside 120, 12VDC NW, L=5m, 7.2W/m, Lead 2x1.8m	1	Pc	1	7,000	94054231
	9335237	9335237	Versa Inside 2x160, 12VDC MW <sup>2</sup> , L=3.0m, 9.6W/m, Lead 2x1.8m (MultiWhite accessories required)	1	Pc	1	16,000	94054231
	9335236	9335236	Versa Inside 160, 12VDC WW, L=3m, 9.6W/m, Lead 2x1.8m	1	Pc	1	8,000	94054231
	9335235	9335235	Versa Inside 160, 12VDC NW, L=3m, 9.6W/m, Lead 2x1.8m	1	Pc	1	8,000	94054231
	9335238	9335238	Versa Linear COB, 12VDC WW, L=3m, 10W/m, lead 2x1.8m	1	Pc	1	5,350	94054231
	9335240	9335240	Versa up&down, 2x80, 12VDC WW, L=3m, 9.6W/m, Lead 2x1.8m	1	Pc	1	10,900	94054231
9335239	9335239	Versa up&down, 2x80, 12VDC NW, L=3m, 9.6W/m, Lead 2x1.8m	1	Pc	1	10,900	94054231	
	<b>Linear Light Accessories</b>							
	9315676	9315676	Direct Connector (Max.36 Watt)	1	Pc	1	110	94059200
	9315677	9315677	Flexible Connector, L=50mm (Max. 36 Watt)	1	Pc	1	240	94059200
	9310240	9310240	Flexible Connector, L=150mm (Max. 36 Watt)	1	Pc	1	270	85444290
	9310035	9310035	Feeder, L=1800mm (Max. 36 Watt)	1	Pc	1	340	85444290
	9310032	9310032	Direct Connector (Max.36 Watt)	10	Pc	1	950	94059200
	9310033	9310033	Flexible Connector, L=50mm (Max. 36 Watt)	10	Pc	1	2,450	85444290
	9326308	9326308	Flexible Connector, L=150mm (Max. 36 Watt)	10	Pc	1	2,650	85444290
	9321363	9321363	Direct connector COB	1	Pc	1	220	85366990
	9321364	9321364	Flexible Connector COB, L=50mm	1	Pc	1	560	85444290
9321365	9321365	Flexible Connector COB, L=150mm	1	Pc	1	560	85444290	
9321366	9321366	Feeder COB, L=1800mm	1	Pc	1	560	85444290	
<b>Profiles</b>								
	<b>ChannelLine A</b>							
	9084267	9084267	ChannelLine A, L=4000 mm, Alu profile & Opal Cover	1	Pc	1	9,350	94059200
9244246	9244246	ChannelLine A End cap (Set of 2)	1	Set	1	110	94059200	
	<b>ChannelLine B</b>							
	9308463	9308463	ChannelLine B, L=3000 mm, Alu profile & Opal Cover	1	Pc	1	5,750	94059900
	9310124	9310124	ChannelLine B End cap Type 2 (Set of 2),Alu	1	Set	1	190	94059200
	9310125	9310125	ChannelLine B, L=3000, Black Alu profile & Opal Cover	1	Pc	1	6,400	94059900
9310128	9310128	ChannelLine B End cap type 2 (Set of 2), Black	1	Set	1	190	94059200	

Product	Article No.	SAP	Item Description	Qty.	Unit	PU	MRP	HS Code
	<b>ChannelLine C</b>							
	9310129	9310129	ChannelLine C, L=3000, Alu profile & Opal Cover	1	Pc	1	5,250	94059900
	9310130	9310130	ChannelLine C End cap Type 2 (Set of 2), Alu	1	Set	1	190	94059200
	9310132	9310132	ChannelLine C, L=3000, Black Alu profile & Opal Cover	1	Pc	1	6,400	94059900
	9310135	9310135	ChannelLine C End cap type 2 (Set of 2), Black	1	Set	1	190	94059200
	<b>ChannelLine D</b>							
	9310137	9310137	ChannelLine D, L=3000, Alu profile & Opal Cover	1	Pc	1	5,400	94059900
	9244279	9244279	ChannelLine D End cap (Set of 2), Alu	1	Set	1	150	94059200
	9310138	9310138	ChannelLine D, L=3000, Black Alu profile & Opal Cover	1	Pc	1	5,950	94059900
	9310139	9310139	ChannelLine D (End cap Set of 2), Black	1	Set	1	150	94059200
	<b>ChannelLine i</b>							
	9310141	9310141	ChannelLine i, L=3000, Alu profile & Opal Cover	1	Pc	1	4,700	94059900
	9244281	9244281	ChannelLine i End cap (Set of 2), Alu	1	Set	1	110	94059200
	9312166	9312166	ChannelLine i, L=3000, Black Alu profile & Opal Cover	1	Pc	1	4,850	94059900
	9312165	9312165	ChannelLine i End cap (Set of 2), Black	1	Set	1	110	94059200
	<b>ChannelLine i2</b>							
	9321548	9321548	ChannelLine i2, L=3000, Alu profile & Opal Cover	1	Pc	1	5,250	94059900
	9321550	9321550	ChannelLine i2, End cap (Set of 2), Alu	1	Set	1	190	94059200
	9321549	9321549	ChannelLine i2, L=3000, Black Alu profile & Opal Cover	1	Pc	1	5,000	94059900
	9321691	9321691	ChannelLine i2, End cap (Set of 2), Black	1	Set	1	110	94059200
	<b>ChannelLine G2</b>							
	9315697	9315697	ChannelLine G2, L=3000, Alu profile & Opal Cover	1	Pc	1	6,550	94059900
	9244283	9244283	ChannelLine G2 End cap (Set of 2), Alu	1	Set	1	140	94059200
	9315698	9315698	ChannelLine G2, L=3000, Black Alu profile & Opal Cover	1	Pc	1	6,200	94059900
	9304152	9304152	ChannelLine G2 End cap (Set of 2), Black	1	Set	1	140	94059200
	<b>ChannelLine H</b>							
	9244566	9244566	ChannelLine H, L=3000, Alu profile & Opal Cover	1	Pc	1	5,250	94054900
	9244567	9244567	ChannelLine H (End cap Set of 2)	1	Set	1	110	94054900
	<b>ChannelLine F</b>							
9162630	9162630	ChannelLine F, L=3000, Opal Cover	1	Pc	1	3,100	94054900	

Product	Article No.	SAP	Item Description	Qty.	Unit	PU	MRP	HS Code
<b>Spot Light</b>								
	<b>SuperSpot Eco</b>							
	9335242	9335242	SuperSpot Eco WW, 12VDC, 4.2W, Stainless Steel	1	Pc	1	3,350	94054239
	9335241	9335241	SuperSpot Eco NW, 12VDC, 4.2W, Stainless Steel	1	Set	1	3,350	94054239
	<b>LitePanel 68</b>							
	9335243	9335243	LitePanel 68 MW <sup>2</sup> 12VDC, 4.3W, Black (Connected directly to an electronic ballast, the light colour is Xtra Warm White (2700K))	1	Pc	1	2,500	94054239
	<b>MultiLite Flood</b>							
	9335244	9335244	MultiLite Flood WW, 12VDC, 4W, round, without ring	1	Pc	1	2,000	94054231
	9245072	9245072	MultiLite Flood cover ring, Alu Look	1	Pc	1	320	94059200
	9245073	9245073	MultiLite Flood-cover ring, Chrome Matt	1	Pc	1	320	94059200
	9245077	9245077	MultiLite Flood-cover ring, Stainless Steel look	1	Pc	1	470	94059200
	9254413	9254413	MultiLite Flood-cover ring, Gold coloured	1	Pc	1	370	94059200
	9254414	9254414	MultiLite Flood-cover ring, Bronze look	1	Pc	1	170	94059200
	9279478	9279478	MultiLite Flood-cover ring, Black	1	Pc	1	470	94059200
	<b>PowerLite Plus</b>							
	9335247	9335247	PowerLite WW, 12VDC, 3.5W, Stainless Steel	1	Pc	1	2,550	94054239
	9335246	9335246	PowerLite NW, 12VDC, 3.5W, Stainless Steel	1	Pc	1	2,550	94054239
	<b>EcoPower L</b>							
	9335248	9335248	Eco Power L WW, 12VDC, 3.2W, Stainless Steel	1	Pc	1	1,750	94054231
	9335249	9335249	EcoPower L WW, 12VDC, 3.2W, Black	1	Pc	1	1,600	94054231
	<b>Eco Spot</b>							
	9335250	9335250	Eco Spot WW, 12VDC, 1.5W, Stainless Steel	1	Pc	1	1,100	94054231
	<b>SideSpot</b>							
	9335251	9335251	Side Spot, Extra WW, 12VDC, 1.4W, Black	1	Pc	1	1,350	94054239



# Magic Lights

## ► Special Lights & Switching Systems





Product	Article No.	SAP	Item Description	Qty.	Unit	PU	MRP	HS Code
<b>Special lights</b>								
	<b>HandleLine</b>							
	9335192	9335192	HandleLine i MW <sup>2</sup> Stainless Steel, 567mm, 12VDC, max. 5.3W	1	Pc	1	3,000	94054239
	9335193	9335193	HandleLine i MW <sup>2</sup> Stainless Steel, 867mm, 12VDC, max. 8.2W	1	Pc	1	4,350	94054239
	9335194	9335194	HandleLine i MW <sup>2</sup> Stainless Steel, 967mm, 12VDC, max. 9.2W	1	Pc	1	4,550	94054239
	9335195	9335195	HandleLine i MW <sup>2</sup> Stainless Steel, 1167mm, 12VDC, max. 11.1W	1	Pc	1	5,650	94054239
	9335196	9335192	HandleLine i MW <sup>2</sup> blackopal 567mm,12VDC, max. 5.3W	1	Pc	1	4,810	94054239
	9335197	9335197	HandleLine i MW <sup>2</sup> blackopal 867mm, 12VDC, max. 8.2W	1	Pc	1	4,550	94054239
	9335198	9335198	HandleLine i MW <sup>2</sup> blackopal 967mm, 12VDC, max. 9.2W	1	Pc	1	4,750	94054239
9335199	9335199	HandleLine i MW <sup>2</sup> blackopal 1167mm, 12VDC, max. 11.1W (Connected directly to an electronic ballast, the light colour is XtraWarmWhite (2700K))	1	Pc	1	5,800	94054239	
	<b>LitePipe</b>							
	9335255	9335255	Lite Pipe, 1000mm, Alu, WW, 12VDC, 5.0W	1	Pc	1	10,450	94054239
	9335254	9335254	Lite Pipe, 1200mm, Alu, WW, 12VDC, 5.5W	1	Pc	1	11,420	94054239
	9335253	9335253	Lite Pipe, 1000mm, Alu, NW, 12VDC, 5.0W	1	Pc	1	10,450	94054239
9335252	9335252	Lite Pipe, 1200mm, Alu, NW, 12VDC, 5.5W	1	Pc	1	11,420	94054239	
	<b>InnoLine Plus</b>							
	9335256	9335256	Innoline Plus, NW, 12VDC, 2.3W, L=401-500mm, IR Sensor	1	Pc	1	5,320	94054239
	9335257	9335257	Innoline Plus, NW, 12VDC, 2.8W, L=501-600mm, IR Sensor	1	Pc	1	4,900	94054239
	9335258	9335258	Innoline Plus, NW, 12VDC, 4.2W, L=801-900mm, IR Sensor	1	Pc	1	6,500	94054239
	9335259	9335259	Innoline Plus, NW, 12VDC, 4.7W, L=901-1000mm, IR Sensor	1	Pc	1	6,500	94054239
9335260	9335260	Innoline Plus, NW, 12VDC, 5.7W, L=1101-1200mm, IR Sensor	1	Pc	1	7,500	94054239	
<b>Switching System</b>								
	<b>X Mitter</b>							
	9326539	9326539	X-Mitter Smart Remote control incl. Mounting Ring (Zigbee)	1	Pc	1	3,850	85365005
	9326532	9326532	Smart Receiver 12VDC, Max.36W	1	Pc	1	5,250	85371000
9326538	9326538	Extension set, 12VDC (Smart Receiver Max. 36 watt & 60W Ballast, M1x9)	1	Set	1	13,500	85365005	
	<b>S Mitter</b>							
	9326542	9326542	S-Mitter Smart set, 12VDC (5-channel smart remote control & Smart Receiver, Max 36 Watt)	1	Set	1	10,600	85365005
	9326545	9326545	S-Mitter Smart Remote control	1	Pc	1	4,050	85365005
	9326532	9326532	Smart Receiver 12VDC, Max.36W	1	Pc	1	5,250	85371000
9326538	9326538	Extension set, 12VDC (Smart Receiver Max. 36 watt & 60W Ballast, M1x9)	1	Set	1	13,500	85365005	
	<b>4 Mitter</b>							
9312046	9312046	4-Mitter Smart Set 12VDC, (4-channel remote control and smart receiver, Max. 4x36 Watt)	1	Set	1	12,500	85365005	

Product	Article No.	SAP	Item Description	Qty.	Unit	PU	MRP	HS Code	
	<b>S Mitter Multiwhite</b>								
	9326546	9326546	S-Mitter MW <sup>2</sup> Smart Remote control	1	Pc	1	4,050	85371000	
	9312158	9312158	Smart Receiver MW <sup>2</sup> , 1- Channel, Max.36W	1	Pc	1	5,250	85365005	
	9312160	9312160	Extension Set 12VDC (Smart Receiver & 60 W Ballast, M1x9)	1	Set	1	15,000	85365005	
	<b>S Mitter basic Multiwhite</b>								
	9312157	9312157	S-Mitter Basic MW <sup>2</sup> Remote control	1	Pc	1	3,850	85371000	
	9312158	9312158	Smart Receiver MW <sup>2</sup> , 1- Channel, Max.36W	1	Pc	1	5,250	85365005	
	9312160	9312160	Extension Set 12VDC (Smart Receiver & 60 W Ballast, M1x9)	1	Set	1	15,000	85365005	
	<b>MultiSwitch<sup>2</sup> Contact</b>								
	9308466	9308466	MultiSwitch <sup>2</sup> drill in sensor, Alu (IR Sensor or door contact switch)	1	Pc	1	1,750	85365090	
	9312193	9312193	MultiSwitch <sup>2</sup> drill in sensor, Black (IR Sensor or door contact switch)	1	Pc	1	1,600	85365005	
	9309582	9309582	MultiSwitch <sup>2</sup> IR surface mounted, Alu (IR sensor or door contact switch)	1	Pc	1	1,900	85365090	
	9312192	9312192	MultiSwitch <sup>2</sup> IR surface mounted, Black (IR sensor or door contact switch)	1	Pc	1	1,750	85365005	
	9308462	9308462	MultiSwitch <sup>2</sup> Master 12VDC, Max.36W	1	Pc	1	3,000	85365090	
	9326517	9326517	MultiSwitch <sup>2</sup> Master 230-240V, AC, 500 W, 3m Euro Plug 150mm, Jack	1	Pc	1	5,300	85365005	
	9315711	9315711	Extension MultiSwitch <sup>2</sup> 3000mm	1	Pc	1	370	85444290	
	<b>MultiSwitch<sup>2</sup> PIR</b>								
	9312194	9312194	MultiSwitch <sup>2</sup> PIR sensor for surface mounting, Alu (motion sensor)	1	Pc	1	1,800	85365090	
	9312195	9312195	MultiSwitch <sup>2</sup> PIR sensor for surface mounting, Black (motion sensor)	1	Pc	1	1,600	85365005	
	9308462	9308462	MultiSwitch <sup>2</sup> Master 12VDC, Max.36W	1	Pc	1	3,000	85365090	
	9326517	9326517	MultiSwitch <sup>2</sup> Master 230-240V, AC, 500 W, 3m Euro Plug 150mm, Jack	1	Pc	1	5,300	85365005	
	9315711	9315711	Extension MultiSwitch <sup>2</sup> 3000mm	1	Pc	1	370	85444290	
	<b>Repeater</b>								
	9246079	9246079	Repeater for 12VDC, Max.36W	1	Pc	1	1,700	85365090	
	<b>IR Door Switch</b>								
	9267112	9267112	IR Door Switch 12VDC, Max. 36W, Lead M1 (Drill in sensor)	1	Pc	1	1,950	85365090	
	<b>LED Motion Sensor</b>								
	9267111	9267111	LED Motion sensor 12VDC max. 36W, Lead M1 (Drill in Sensor)	1	Pc	1	1,350	85365090	

# Magic Lights

## ► Ballast/Leads



Product	Article No.	SAP	Item Description	Qty.	Unit	PU	MRP	HS Code
<b>Ballast/Leads</b>								
	<b>Ballast</b>							
	9335261	9335261	LED ballast 12VDC, 6W , Europlug M1x1	1	Pc	1	2,300	85044082
	9335262	9335262	LED ballast 12VDC, 15W, 200-240V, 2m EFS 0.2m, M1+0.15m, M1x6 (6-Way Distributor)	1	Pc	1	2,300	85044082
	9335263	9335263	LED ballast.12VDC, 20W,200-240V, 2m EFS 0.2m, M1+0.15m, M1x6 (6-Way Distributor)	1	Pc	1	2,400	85044082
	9335264	9335264	LED ballast. 12VDC, 30W,200-240V, 2m EFS 0.2m, M1+0.15m, M1x6 (6-Way Distributor)	1	Pc	1	4,500	85044082
9335265	9335265	LED ballast. 12VDC, 60W, 2m EFS 0.15m, M1x9 (9-Way Distributor)	1	Pc	1	6,150	85044082	
	<b>Leads</b>							
	9104773	9104773	LED extension M1 12VDC, L=1800mm, Black	1	Pc	1	440	85444290
	9246083	9246083	LED 6-way Distributor M1, 12VDC, L=200mm, Black	1	Pc	1	270	85444290
9084272	9084272	LED 6-way distributor M1, 12VDC, L=2000mm, Black	1	Pc	1	560	85444290	



- WW - Warm White
- NW - Neutral White
- MW - Multi White



Floor Spring

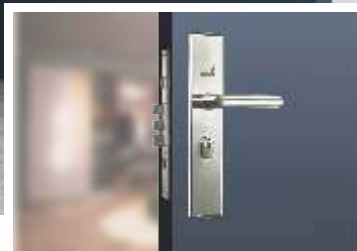

Main Door Locks



Door Closer

## Door Hardware

Make your home/office safe & secure

Hettich Architectural Hardware solutions are a perfect combination of cutting-edge German technology and exceptional design to keep your residential and commercial spaces smart and secure. From controlling the movement of doors through doors closer to secured locking solutions, from elegant glass solutions to the application of acoustic seals for extra comfort; the range has it all.

IT'S ALL IN HETTICH.



Product	Article No.	SAP	Item Description	Qty.	Unit	PU	MRP	HS Code
 	<b>Mortise flush Door Hinge: HBN 14 Series</b>							
	9228734	9228734	HBN-14 4x3x3 Square edge Z shape drilling pattern for timber doors, Capacity 160KG EN 1935 Grade14, Finish SS	1	Pair	1	1,748	83024110
	9228745	9228745	HBN-14 5x3x3 Square edge Z shape drilling pattern for timber doors, Capacity 160KG EN 1935 Grade14, Finish SS	1	Pair	1	1,875	83024110
	9250468	9250468	HBN-14 5x4x3 Square edge Z shape drilling pattern for timber doors, Capacity 160KG EN 1935 Grade14, Finish SS	1	Pair	1	2,026	83024110
<b>HIN - Ball Bearing Hinge: SS 304, 105 min Fire rated, 200,000 Cycle, 5 years Functional Warranty</b>								
	<b>HIN - Ball Bearing Hinge</b>							
	9287297	9287297	SS 304 Hinge SQR 4"x3"x3 up to 80 kg per 3 hinges, SS Finish (without screws)	1	Pair	100	880	83021000
	9287298	9287298	SS 304 hinge SQR 5x3x3 Loading Capacity up to 80 kg per 3 hinges SS Finish (without screws)	1	Pair	100	1,075	83021000
	<b>HIN - Ball Bearing Hinge Satin Stainless Steel (SSS) Finish</b>							
	9268384	9268384	SS 304 Hinge 4"x3"x3 Round Corner (Hole Pattern:C)	1	Pair	20	1,050	83021000
	9268632	9268632	SS 304 Hinge 5"x3"x3 Round Corner (Hole Pattern:Z) (Supplied with screws)	1	Pair	20	1,200	83021000
	<b>HIN - Ball Bearing Hinge Antique Brass (AB) Finish</b>							
	9268383	9268383	SS 304 Hinge 4"x3"x3 Square Corner (Hole Pattern:C)	1	Pair	20	1,266	83021000
	9268390	9268390	SS 304 Hinge 5"x3"x3 Square Corner (Hole Pattern:Z) (Supplied with screws)	1	Pair	20	1,452	83021000
	<b>Spring Hinge</b>							
9228242	9228242	HBN-18-102/102-SPR: Spring Hinge, 4"x4"x3, SS 304, loading capacity 40kg/pair	01	Pair	1	1,901	83021090	
	<b>Flush Hinge</b>							
9228247	9228247	HBN- 13-4325ZM/102: Flush Hinge, 4"x3"x2.5 loading capacity 40kg/pair	1	Pair	1	953	83021090	
	<b>Concealed Hinges (Hinge Material: Base: Zinc Alloy; Connector: SS 304)</b>							
9228248	9228248	HBC-25-1835/117: Concealed Hinge for min door thickness: 29 mm, loading capacity: 30 kg/pair, Supplied with SS 304 screws	1	Pair	1	4,241	83021090	

Note: Please refer Architectural Hardware Exclusive Price List for all available solutions



Product	Article No.	SAP	Item Description	Qty.	Unit	PU	MRP	HS Code
	<b>3D Concealed Hinges (Hinge Material: Base: Zinc Alloy; Connector: Aluminum Alloy)</b>							
	9228474	9228474	HBC-25-1440/150Z-3D: 3D-Concealed Hinge Min Door Thickness: 35 mm Loading Capacity: 40 kg/pair, Finish Silver	1	Pair	1	4,298	83021090
	9228475	9228475	HBC-28-1640/177Z-3D: 3D-Concealed Hinge Min Door Thickness: 40 mm Loading Capacity: 80 kg/pair, Finish Silver	1	Pair	1	5,651	83021090
	9228476	9228476	HBC-34-1845/246Z-3D: 3D-Concealed Hinge Min Door Thickness: 45 mm Loading Capacity: 120 kg/pair, Finish Silver	1	Pair	1	9,341	83021090
	9251127	9251127	HBC-28-1640/177Z-3D: 3D-Concealed Hinge Min Door Thickness: 40 mm Loading Capacity: 80 kg/pair, Finish Matt Black	1	Pair	1	6,117	83021090
9251128	9251128	HBC-34-1845/246Z-3D: 3D-Concealed Hinge Min Door Thickness: 45 mm Loading Capacity: 120 kg/pair, Finish Matt Black	1	Pair	1	10,095	83021090	
(Please check AH catalogue 2022 for guidelines before ordering)								





Note: Please refer Architectural Hardware Exclusive Price List for all available solutions

# Door Closer

► Door Closer with Slide Rail/ Standard Arm









Product	Article No.	SAP	Item Description	Qty.	Unit	PU	MRP	HS Code
<b>Surface Mounted Door Closer with Slide rail</b>								
 	<b>HSS 61</b>							
	9250942	9250942	HSS 61 B: EN3-6, For Door Width 950 - 1400 mm, Door weight 60 - 120 kg, adjustable closing/latching speed/back-check, EN1154, slide rail H, hinge side mounting, Non Hold Open (For Hinge Side Only)	1	Set	1	24,182	83024110
 	<b>HSS 41</b>							
	9227808	9227808	HSS 41: EN 1-4, With slide rail B; For Door Width 750-1100 mm and Door Weight 20-120 kg; Fixed Back-check; EN1154 certified, Fire Rated; 500,000 cycles tested.	1	Set	1	15,150	83024110
 	<b>HSS 31</b>							
	9227810	9227810	HSS 31: EN 1-3, With slide rail B; For Door Width 750-950 mm and Door Weight 20-100 kg; Fixed Back-check; EN1154 certified, Fire Rated; 500,000 cycles tested.	1	Set	1	12,318	83024110
 	<b>HSS 33</b>							
	9227812	9227812	HSS 33: EN 3, With slide rail K; For Door Width 750-950 mm and Door Weight 20-80 kg; EN1154 certified, Fire Rated; 500,000 cycles tested. (Cannot be made hold open door closer)	1	Set	1	8,284	83024110
<b>Surface Mounted Door Closer with Standard Arm</b>								
 	<b>HSA 20</b>							
	9227814	9227814	HSA 20: EN 2/3/5, For Door Width 850-1250 mm and Door Weight 20-150 kg; Fixed Back-check; EN1154 certified, Fire Rated; 500,000 cycles tested.	1	Set	1	7,343	83024110
	<b>HSA 14</b>							
	9228418	9228418	HSA 14: EN 1/2/3/4, For Door Width 750-1100 mm and Door Weight 40-80 kg.	1	Set	1	4,935	83024110
 	<b>HSA 10 D EN</b>							
	9228767	9228767	HSA 10 D EN HO: EN 2/3/4, For Door Width 850-1100 mm and Door Weight 40-80 kg; With Hold Open Arm, EN 1154 Certified; Fire Rated.	1	Set	1	4,444	83024110

Note: Please refer Architectural Hardware Exclusive Price List for all available solutions

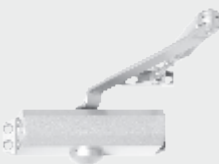
# Door Closer

► Door Closer with Standard Arm/ Concealed Door Closer



Product	Article No.	SAP	Item Description	Qty.	Unit	PU	MRP	HS Code
	<b>HSA 10 F</b>							
	9227816	9227816	HSA 10 F: EN 2/3/4, For Door Width 850-1100 mm and Door Weight 40-80 kg; Fire Rated; with standard arm	1	Set	1	3,038	83024110
	9228766	9228766	HSA 10 F HO: EN 2/3/4, For Door Width 850-1100 mm and Door Weight 40-80 kg, with Hold Open Arm, Fire Rated	1	Set	1	3,923	83024110
	<b>HSA 10</b>							
	9227818*	9227818*	HSA 10: EN 2/3/4, For Door Width 850-1100 mm and Door Weight 40-80 kg, with standard arm	1	Set	1	2,592	83024110
	<b>New HSA 10</b>							
	9250948	9250948	New HSA 10: EN 2/3/4, For Door Width 850-1100 mm and Door Weight 40-80 kg, with standard arm	1	Set	1	2,592	83024100
	9250949	9250949	New HSA 10 HO: EN 2/3/4, For Door Width 850-1100 mm and Door Weight 40-80 kg, With Hold Open Arm	1	Set	1	3,504	83024100
	<b>HSA 10 X</b>							
	9250587*	9250587*	HSA 10 X: EN 3, For Door Width 750-1000 mm and Door Weight 20-60 kg, with standard arm	1	Set	1	1,995	83014000
<b>Concealed Door Closer with hold open Slide rail</b>								
	<b>HCS 400</b>							
	9250843	9250843	HCS 400 with hold open Slide rail: EN 2-4, For Door Width 850-1100 mm and Door Weight 40-120 kg; EN1154 Certified; Fire rated; 500,000 cycle tested (Min. Door Thickness - 40 mm) Fire Rating of 120 minutes applicable if used without HO unit	1	Set	1	15,158	83024110
	<b>HCS 385</b>							
	9227823*	9227823*	HCS 385: EN 2-4, with hold open slide rail; For door width 850-1100 mm and door weight 40-80 kg (Min. Door Thickness - 45 mm)	1	Set	1	7,978	83024190
	9250955	9250955	HCS 385: EN 2-4, with hold open slide rail; For door width 850-1100 mm and door weight 40-80 kg (Min. Door Thickness - 47 mm)	1	Set	1	7,978	83024100
	<b>HCS 380</b>							
	9227824*	9227824*	HCS 380: EN 3, with hold open slide rail; For door width 950 mm and Door Weight 60 kg (Min. Door Thickness - 40 mm)	1	Set	1	5,952	83024190
	9250954	9250954	HCS 380: EN 3, with hold open slide rail; For door width 950 mm and Door Weight 60 kg (Min. Door Thickness - 40 mm)	1	Set	1	5,952	83024100
	<b>Hold Open Device - FKL-GS-B</b>							
	9227829	9227829	Hold open arm (70-130 deg) for all standard arm model	1	Set	1	2,030	83024190
	9227831	9227831	FKL Hold Open device for slide rail B for Models: HSS 61/51/41/31 (not to be used with HSS 33)	1	Set	1	962	83024110









\*Available still stock last

Note: Please refer Architectural Hardware Exclusive Price List for all available solutions

# Mortise Locking Solution

► ProLock 1



Product	Article No.	SAP	Item Description	Qty.	Unit	PU	MRP	HS Code
<b>Mortise Handles-ProLock 1 SS 304, ; 200,000 cycles tested in-house lab.; 5 years Functional Warranty</b>								
 <b>F</b>	<b>Prolock 1 HH 2110 (Hollow) (Suitable for door thickness of 40-60 mm)</b>							
	9228099	9228099	ProLock 1 HH 2110 Handle + Handle set SS	1	Set	1	1,468	83024190
	9250012	9250012	ProLock 1 HH 2110 Handle + Handle set BL	1	Set	1	2,861	83024190
 <b>F</b>	<b>Prolock 1 HH 2210 (Hollow) (Suitable for door thickness of 40-60 mm)</b>							
	9250321	9250321	ProLock 1 HH 2210 Handle + Handle set SS	1	Set	1	1,458	83024110
 <b>F</b>	<b>Prolock 1 HH 2310 (Hollow) (Suitable for door thickness of 40-60 mm)</b>							
	9228102	9228102	ProLock 1 HH 2310 Handle + Handle set SS(Please order only Bathroom Lock along with WC version set)	1	Set	1	1,468	83024110
 <b>F</b>	<b>Prolock 1 HH 2340 (Hollow) (Suitable for door thickness of 40-60 mm)</b>							
	9228108	9228108	ProLock 1 HH 2340 Handle + Handle set SS	1	Set	1	1,458	83024110
 <b>F</b>	<b>Prolock 1 HH 2410 (Hollow) (Suitable for door thickness of 40-60 mm)</b>							
	9228111	9228111	ProLock 1 HH 2410 Handle + Handle set SS	1	Set	1	2,007	83024110
 <b>F</b>	<b>Prolock 1 HH 2510 (Hollow) (Suitable for door thickness of 40-60 mm)</b>							
	9251130	9251130	ProLock 1 HH 2510 Handle + Handle set SS	1	Set	1	1,458	83024110
 <b>F</b>	<b>Prolock 1 HH 2610 (SS 304 Solid Die cast) (Suitable for door thickness of 40-60 mm)</b>							
	9228768	9228768	ProLock 1 HH 2610 Handle + Handle set SS	1	Set	1	3,264	83024110
 <b>F</b>	<b>Prolock 1 HH 2620 (SS 304 Solid Die cast) (Suitable for door thickness of 40-60 mm)</b>							
	9228770	9228770	ProLock 1 HH 2620 Handle + Handle set SS	1	Set	1	3,264	83024110









Note: Please refer Architectural Hardware Exclusive Price List for all available solutions

SS: Stainless Steel	AB: Antique Brass	CR: Chrome	BL: Black	SB: Satin Brass
---------------------	-------------------	------------	-----------	-----------------

# Mortise Locking Solution

► ProLock 1



Product	Article No.	SAP	Item Description	Qty.	Unit	PU	MRP	HS Code
	<b>Prolock 1 HH 2630 (SS 304 Solid Die cast) (Suitable for door thickness of 40-60 mm)</b>							
	9228772	9228772	ProLock 1 HH 2630 Handle + Handle set SS	1	Set	1	3,264	83024110
	<b>Prolock 1 HH 2650 (SS 304 Solid Die cast) (Suitable for door thickness of 40-60 mm)</b>							
	9228776	9228776	ProLock 1 HH 2650 Handle + Handle set SS	1	Set	1	3,395	83024110
	<b>Prolock 1 HH 2670 (SS 304 Solid Die cast) (Suitable for door thickness of 40-60 mm)</b>							
	9228780	9228780	ProLock 1 HH 2670 Handle + Handle set SS	1	Set	1	3,395	83024110
	<b>Prolock 1 HH 2760 (Hollow) (Suitable for door thickness of 40-60 mm)</b>							
	9228794	9228794	ProLock 1 HH 2760 Handle + Handle set SS	1	Set	1	2,007	83024110
	9249949	9249949	ProLock 1 HH 2760 Handle + Handle set AB	1	Set	1	2,509	83024190
<b>Mortise handle Prolock 1 SS 304; 200,000 cycles tested in-house lab.; 5 years Functional Warranty</b>								
 <span style="border: 1px solid red; padding: 2px;">F</span>	<b>Prolock 1 HH 2110 (Oval Rose Hollow Handles) (Suitable for door thickness of 40-60 mm)</b>							
	9228117	9228117	ProLock 1 HH 2110/O Handle + Handle set SS (Please order Profile Sash Lock with this handles)	1	Set	1	1,659	83024110
<b>Spare Escutcheons</b>								
	<b>Round PZ Escutcheon (For Dead bolt / Roller Latch / Single Dead Bolt Lock Only)</b>							
	9228459	9228459	Round PZ Escutcheon 1	1	Set	1	283	83014090
	<b>Oval PZ Escutcheon</b>							
	9250390	9250390	Oval PZ Escutcheon	1	Set	1	326	83014090
	<b>Round WC Escutcheon (For single bathroom lock only) (For Door thickness 30-45 mm)</b>							
	9228706	9228706	Round WC Escutcheon 1	1	Set	1	944	83014090

Note: Please refer Architectural Hardware Exclusive Price List for all available solutions

SS: Stainless Steel

AB: Antique Brass

CR: Chrome

BL: Black

SB: Satin Brass



# Mortise Locking Solution

► Sash Lock



Product	Article No.	SAP	Item Description	Qty.	Unit	PU	MRP	HS Code
<b>Lock Body (72 mm Centre to Centre Distance)</b>								
	<b>Sash Locks (For Main and Internal doors)</b>							
	9228136	9228136	HBS 31 FSL: Sash Lock DIN Left/Right CTC 72 & Backset 55 SS Finish	1	Set	1	1,694	83014090
	9228137	9228137	HBS 31 FSL: Sash Lock DIN Left/Right CTC 72 & Backset 60 SS Finish	1	Set	1	1,729	83014090
	9250117	9250117	HBS 31 FSL: Sash Lock DIN Left/Right CTC 72 & Backset 55 AB Finish	1	Set	1	1,924	83014090



Note: Please refer Architectural Hardware Exclusive Price List for all available solutions

SS: Stainless Steel	AB: Antique Brass	CR: Chrome	BL: Black	SB: Satin Brass
---------------------	-------------------	------------	-----------	-----------------

# Mortise Locking Solution

- ▶ Sash Lock, Profile Lock Body
- ▶ Sash/Dead Lock (EN Series)



Product	Article No.	SAP	Item Description	Qty.	Unit	PU	MRP	HS Code
<b>Lock Body (85/92 mm Centre to Centre Distance)</b>								
	<b>Sash Lock (For Main and Internal doors)</b>							
	9228576	9228576	HBS 31 FSL: Sash Lock DIN Left/Right CTC 85 Et Backset 45 SS Finish	1	Set	1	1,577	83014090
	9228578	9228578	HBS 31 FSL: Sash Lock DIN Left/Right CTC 85 Et Backset 55 SS Finish	1	Set	1	1,600	83014090
	9228579	9228579	HBS 31 FSL: Sash Lock DIN Left/Right CTC 85 Et Backset 60 SS Finish	1	Set	1	1,635	83014090
	9250131	9250131	HBS 31 FSL: Sash Lock DIN Left/Right CTC 85 Et Backset 55 - AB Finish	1	Set	1	1,810	83021090
	<b>Profile Lock Body</b>							
	9228575	9228575	HBS 31 FSL: Profile Sash Lock DIN Left/Right CTC 85 Et Backset 35 SS	1	Set	1	1,170	83014090
	9228586	9228586	HBS 31 FDL: Profile Dead Lock DIN Left/Right CTC 85 Et Backset 30 SS	1	Set	1	1,055	83014090
<b>Lock Body EN 12209 Series (72 mm CTC locks) SS 304: Latch and Dead Bolt; 200,000 cycles tested; 5 years Functional Warranty</b>								
 	<b>Sash Lock (For Fire Rated Main and Internal doors)</b>							
	9251082	9251082	HBS 31 FESL: Sash Lock DIN Left/Right CTC 72 Et Backset 60 EN 12209, Fire Rated	1	Set	1	1,549	83014090
	<b>Dead Lock (For fire rated doors)</b>							
	9251086	9251086	HBS 31 FEDL 72/55 Sq 24 mm edge EN 12209	1	Set	1	1,086	83021090

Note: Please refer Architectural Hardware Exclusive Price List for all available solutions

SS: Stainless Steel

AB: Antique Brass

PSS: Polished Stainless Steel

BL: Black

SB: Satin Brass

# Mortise Locking Solution

## ► Special Locks









Product	Article No.	SAP	Item Description	Qty.	Unit	PU	MRP	HS Code
<b>Special locks</b>								
	<b>Security Lock</b>							
	9250585	9250585	HBS 31 SL: Security Lock DIN Left/Right CTC 85 Et Backset 60	1	Set	1	1,674	83014090
	<b>Roller Latch (For two way opening doors)</b>							
	9228147	9228147	HBS 31 FRL: Roller Latch Lock DIN Left/Right CTC 72 Et Backset 60	1	Set	1	2,091	83014090
	9228459	9228459	Round PZ Escutcheon (Please Order Escutcheon separately)	1	Set	1	283	83014090
	<b>Bathroom Lock (For use in bathroom doors with WC version handles)</b>							
	9228142	9228142	HBS 31 FBL: Bathroom Lock DIN Left/Right CTC 78 Et Backset 55 SS Finish	1	Set	1	1,843	83014090
	9228143	9228143	HBS 31 FBL: Bathroom Lock DIN Left/Right CTC 78 Et backset 60 SS Finish	1	Set	1	1,885	83014090
	<b>Single Dead Bolt Lock</b>							
	9228148	9228148	HBS 31 FSDL: Single Dead Lock DIN Left/Right Backset 55	1	Set	1	1,312	83014090
	9228459	9228459	Round PZ Escutcheon 1 (Please Order Escutcheon separately)	1	Set	1	283	83014090
	<b>Single Latch Lock</b>							
	9228149	9228149	HBS 31 FSSL: Single Latch Lock DIN Left/Right Backset 55	1	Set	1	1,350	83014090
	<b>Roller Catch Lock</b>							
	9228716	9228716	Roller ball Catch	1	Set	1	1,087	83014090
	<b>Allen key Tubewell Lock</b>							
	9250584	9250584	Allen key Tubewell Lock SS	1	Set	1	812	83014090

Note: Please refer Architectural Hardware Exclusive Price List for all available solutions

# Mortise Locking Solution & Euro Profile Cylinder

► Sliding Locks & HSCL









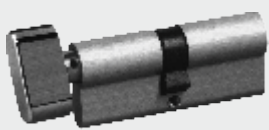

Product	Article No.	SAP	Item Description	Qty.	Unit	PU	MRP	HS Code
<b>Wooden Sliding Locks and Handles / Escutcheons</b>								
	<b>Sliding PZ Lock</b>							
	9228481	9228481	Hettich Sliding Lock PZ DIN Left/Right backset 50 mm (Please order Sliding Handle or Escutcheon & also order Euro Profile cylinder as per door thickness)	1	Set	1	1,261	83014090
	<b>Sliding WC Lock</b>							
	9228482	9228482	Hettich Sliding Lock WC DIN Left/Right backset 50 mm (Please order WC Sliding Handle or Escutcheon )	1	Set	1	1,261	83014090
	<b>Sliding Door WC handle with knob</b>							
	9228712	9228712	WC Sliding Door Handle For Timber Doors SS 304 Satin Finish	1	Set	1	1,563	83014090
	<b>Sliding WC Escutcheon with knob</b>							
	9228713	9228713	WC Sliding Door Escutcheons For Timber Doors SS304 Satin Finish	1	Set	1	1,656	83024190
<b>Euro profile cylinder</b>								
 EN 1303	<b>HSCL - Standard Double Cylinder</b>							
	9228171	9228171	HSCL 60: Both side key 60 mm, for max door thickness - 40 mm - SS Finish	1	Set	1	1,464	83014090
	9228172	9228172	HSCL 70: Both side key 70 mm, for max door thickness - 50 mm - SS Finish	1	Set	1	1,538	83014090
 EN 1303	9250147	9250147	HSCL 70: Both side key 70 mm, for max door thickness - 50 mm - AB Finish	1	Set	1	1,616	83014090

Note: Please refer Architectural Hardware Exclusive Price List for all available solutions

# Mortise Locking Solution

► HTCL, HBCL, HHCL & HHTL



Product	Article No.	SAP	Item Description	Qty.	Unit	PU	MRP	HS Code
<b>HTCL - Thumb Turn Cylinder</b>								
 	9228176	9228176	HTCL 60: One side key and one side knob 60 mm, for max door thickness - 40 mm - SS Finish	1	Set	1	1,619	83014090
	9228177	9228177	HTCL 70: One side key and one side knob 70 mm, for max door thickness - 50 mm - SS Finish	1	Set	1	1,700	83014090
	9228179	9228179	HTCL 80: One side key and one side knob 80 mm, for max door thickness - 60 mm - SS Finish	1	Set	1	1,820	83014090
	9228180	9228180	HTCL 90: One side key and one side knob 90 mm, for max door thickness - 70 mm - SS Finish	1	Set	1	1,940	83014090
	9250324	9250324	HTCL 100: One side key and one side knob 100 mm, for max door thickness - 80 mm - SS Finish	1	Set	1	2,150	83014090
 	9250151	9250151	HTCL 60: One side key and one side knob 60 mm, for max door thickness - 40 mm Finish AB	1	Set	1	1,694	83021090
	9250152	9250152	HTCL 70: One side key and one side knob 70 mm, for max door thickness - 50 mm Finish AB	1	Set	1	1,771	83021090
	9250154	9250154	HTCL 80: One side key and one side knob 80 mm, for max door thickness - 60 mm Finish AB	1	Set	1	1,943	83014090
 	9250243	9250243	HTCL 60: One side key and one side knob 60 mm, for max door thickness - 40 mm Finish BL	1	Set	1	2,387	83021090
	9250244	9250244	HTCL 70: One side key and one side knob 70 mm, for max door thickness - 50 mm Finish BL	1	Set	1	2,468	83021090
	9250246	9250246	HTCL 80: One side key and one side knob 80 mm, for max door thickness - 60 mm Finish BL	1	Set	1	2,584	83021090
<b>HBCL - Bathroom Cylinder</b>								
 	9228181	9228181	HBCL 60: One side knob and one side coin slot 60 mm, for max door thickness-40 mm - SS Finish	1	Set	1	1,110	83014090
	9228182	9228182	HBCL 70: One side knob and one side coin slot 70 mm, for max door thickness-50 mm- SS Finish	1	Set	1	1,189	83014090
 	9250156	9250156	HBCL 60: One side knob and one side coin slot 60 mm, for max door thickness 40 mm finish AB	1	Set	1	1,177	83021090
	9250157	9250157	HBCL 70: One side knob and one side coin slot 70 mm, for max door thickness 50 mm finish AB	1	Set	1	1,250	83021090
 	9250248	9250248	HBCL 60: One side knob and one side coin slot 60 mm, for max door thickness 40 mm finish BL	1	Set	1	1,846	83021090
	9250249	9250249	HBCL 70: One side knob & one side coin slot 70 mm, for max door thickness 50 mm finish BL	1	Set	1	1,922	83014090
<b>HHCL - Half Cylinder</b>								
 	9228184	9228184	HHCL 40: One side key only 40 mm, for max door thickness-40 mm - SS Finish	1	Set	1	1,380	83014090
	9228185	9228185	HHCL 45: One side key only 45 mm, for max door thickness-45 mm - SS Finish	1	Set	1	1,418	83014090
<b>HHTL- Half Thumb Turn Cylinder</b>								
 	9228729	9228729	HHTL 40: One side thumb turn only 40 mm, for max door thickness-40 mm	1	Set	1	1,150	83014090

Note: Please refer Architectural Hardware Exclusive Price List for all available solutions



SS: Stainless Steel	AB: Antique Brass	CR: Chrome	BL: Black	SB: Satin Brass
---------------------	-------------------	------------	-----------	-----------------



# Mortise Locking Solution

► HSCL, HTCL & HHCL

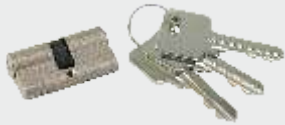

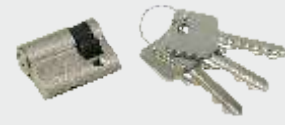
Product	Article No.	SAP	Item Description	Qty.	Unit	PU	MRP	HS Code
<b>Euro Profile Cylinder (with 3 Mechanical Keys)</b>								
	<b>HSCL - Standard Double Cylinder</b>							
	9250500	9250500	HSCL 60 : Both side key 60 mm, for max door thickness - 40 mm - SS Finish (with 3 Mechanical keys)	1	Set	1	1,045	83021090
	9250501	9250501	HSCL 70 : Both side key 70 mm, for max door thickness - 50 mm - SS Finish (with 3 Mechanical key)	1	Set	1	1,122	83021090
	9250502	9250502	HSCL 75 : Both side key 75 mm, for max door thickness - 55 mm - SS Finish (with 3 Mechanical key)	1	Set	1	1,179	83021090
	9250503	9250503	HSCL 80 : Both side key 80 mm, for max door thickness - 60 mm - SS Finish (with 3 Mechanical key)	1	Set	1	1,239	83021090
	9250543	9250543	HSCL 90 : Both side key 90 mm, for max door thickness - 70 mm - SS Finish (with 3 Mechanical key)	1	Set	1	1,352	83021090
	<b>HTCL - Thumb Turn Cylinder</b>							
	9250544	9250544	HTCL 60 : One side key and one side knob 60 mm, for max door thickness - 40 mm - SS Finish (with 3 Mechanical key)	1	Set	1	1,197	83021090
	9250545	9250545	HTCL 70 : One side key and one side knob 70 mm, for max door thickness - 50 mm - SS Finish (with 3 Mechanical key)	1	Set	1	1,274	83021090
	9250546	9250546	HTCL 75 : One side key and one side knob 75 mm, for max door thickness - 55 mm - SS Finish (with 3 Mechanical key)	1	Set	1	1,334	83021090
	9250547	9250547	HTCL 80 : One side key and one side knob 80 mm, for max door thickness - 60 mm - SS Finish (with 3 Mechanical key)	1	Set	1	1,391	83021090
	9250548	9250548	HTCL 90 : One side key and one side knob 90 mm, for max door thickness - 70 mm - SS Finish (with 3 Mechanical key)	1	Set	1	1,507	83021090
	<b>HHCL - Half Cylinder</b>							
	9250549	9250549	HHCL 40 : One side key only 40 mm, for max door thickness-40 mm - SS Finish (with 3 Mechanical key)	1	Set	1	967	83021090
	9250550	9250550	HHCL 45 : One side key only 45 mm, for max door thickness-45 mm - SS Finish (with 3 Mechanical key)	1	Set	1	1,006	83021090

Note: Please refer Architectural Hardware Exclusive Price List for all available solutions

# Panic Bar Solution

▶ HPN 3000 & HPN 500



Product	Article No.	SAP	Item Description	Qty.	Unit	PU	MRP	HS Code
<b>Panic Bar Solution</b>								
 <div style="border: 1px solid red; padding: 2px; display: inline-block;">F</div>	<b>HPN 3000 RIM (Touch Bar Panic Device)</b>							
	9228616	9228616	HPN 3000 RIM: 1 Point Locking, Touch bar, Steel Silver Painted, Fire Rated  (Max. Door dimensions Door Height: 2400 mm   Width: 1100 mm   Thickness 45 - 50 mm)	1	Set	1	7,928	83014090
 <div style="border: 1px solid red; padding: 2px; display: inline-block;">F</div>	<b>HPN 500 IN RIM (Push Bar Panic Device)</b>							
	9228622	9228622	HPN 500 IN RIM: 1 Point Locking, Push bar, Steel Silver Painted, Fire Rated  (Max. Door dimensions Door Height: 2400 mm   Width: 1100 mm   Thickness 45 - 50 mm)	1	Set	1	8,130	83014090
<b>Panic Accessories for HPN 3000 and 500 IN</b>								
	<b>Counter Handle On Rose</b>							
	9228705	9228705	Counter handle for HPN on Rose Silver	1	Set	1	5,136	83014090



Note: Please refer Architectural Hardware Exclusive Price List for all available solutions

Product	Article No.	SAP	Item Description	Qty.	Unit	PU	MRP	HS Code
<b>ProLock Infinity : The Complete Main Door Solution</b>								
	<b>ProLock Infinity Handles Design 1</b>							
	9250858	9250858	ProLock Infinity 1 SS DIN Left- Movable	1	Set	1	4,952	83024110
	9250886	9250886	ProLock Infinity 1 SS DIN Right- Movable	1	Set	1	4,951	83021090
	9250859	9250859	ProLock Infinity 1 AB DIN Left- Movable	1	Set	1	7,470	83021090
	9250887	9250887	ProLock Infinity 1 AB DIN Right- Movable	1	Set	1	7,470	83021090
	<b>ProLock Infinity Handles Design 2</b>							
	9250890	9250890	ProLock Infinity 2 SS DIN Left- Movable	1	Set	1	4,952	83024110
	9250891	9250891	ProLock Infinity 2 SS DIN Right- Movable	1	Set	1	4,952	83024110
	<b>ProLock Infinity Handles Design 3</b>							
	9250863	9250863	ProLock Infinity 3 SS DIN Left- Movable	1	Set	1	4,952	83024110
	9250902	9250902	ProLock Infinity 3 SS DIN Right- Movable	1	Set	1	4,952	83024110
	<b>ProLock Infinity Lock body with 5 point locking system</b>							
	9228517	9228517	HBS 21 FSL: Sash Lock DIN Left/Right CTC 68 & Backset 60 with 3 Bolt, Latch And 1 Manual Bolt SS Finish	1	Set	1	2,497	83014090
	9228629	9228629	HBS 21 FSL: Sash Lock DIN Left/Right CTC 68 & Backset 60 with 3 Bolt, Latch And 1 Manual Bolt AB Finish	1	Set	1	3,096	83021090
	<b>ProLock Infinity Cylinder with 5 Main keys &amp; 2 construction keys</b>							
	9228518	9228518	ProLock Infinity Euro Profile Cylinder with 2 Row Pin, Anti-Drill Pin & Reversible AB Key size: 70 mm SS Finish	1	Set	1	2,898	83014090
	9228630	9228630	ProLock Infinity Euro Profile Cylinder with 2 Row Pin, Anti-Drill Pin & Reversible AB Key size: 70 mm AB Finish	1	Set	1	3,799	83021090

Note: Please refer Architectural Hardware Exclusive Price List for all available solutions

SS: Stainless Steel

AB: Antique Brass

CR: Chrome

BL: Black

SB: Satin Brass

# Cylindrical Knob Set & Floor Spring

- ▶ 840 Series, 750 Series, 650 Series,
- ▶ Accessories & Floor Pivot/Hinge













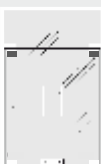

Product	Article No.	SAP	Item Description	Qty.	Unit	PU	MRP	HS Code
<b>Cylindrical Knob Set</b>								
	<b>HCK 01 (Backset 60 mm &amp; Door thickness 30 to 45 mm)</b>							
	9228335	9228335	HCK 01 SS: One side Key and one side knob (For Room Doors), with 3 keys, dia. 65 mm	1	Set	1	1,114	83024110
	9228336	9228336	HCK 01 SS WC: One side Knob and other side emergency release slot, without key (for Washroom Doors), dia. 65 mm	1	Set	1	957	83024110
	9250827	9250827	HCK 01 SS BD: One side Knob and other side Dead Knob (for Balcony Doors), dia. 65 mm	1	Set	1	997	83024110
	9228339	9228339	HCK 01 AB: One side Key and one side Knob (For Room Doors), with 3 keys, dia. 65 mm	1	Set	1	1,282	83024110
	9228340	9228340	HCK 01 AB WC: One side Knob and other side emergency release slot, without key (for Washroom Doors), dia. 65 mm	1	Set	1	1,140	83024110
<b>Note: SS: Stainless Steel AB: Antique Brass</b>								
<b>Floor Spring</b>								
	<b>840 Series (Door Weight 150 Kg)</b>							
	9227847	9227847	HTS FS 844 (Body): For Door Width 1100 mm, Hold open at 90° without accessories; EN1154 Certified; 500,000 cycle tested; Fire rated.  Fire Rating of 120 minutes applicable if used without HO unit	1	Set	1	9,605	83024110
	<b>750 Series (Door Weight 80 / 100 Kg)</b>							
	9250946	9250946	HTS FS 754: EN 4, For Door Width 1100 mm, Door Weight 80 kg, Hold Open at 90°, without accessories	1	Set	1	6,685	83024100
	9250947	9250947	HTS FS 755: EN 5, For Door Width 1250 mm, Door Weight 100 kg, Hold Open at 90°, without accessories	1	Set	1	6,685	83024100
	<b>650 Series (Door Weight 100 Kg)</b>							
	9227856	9227856	HTS FS 654: For Door Width 1100 mm, Hold open at 90°, without accessories; 200,000 cycle in-house lab tested.	1	Set	1	8,010	83024110
	<b>Floor Spring Accessories for Wooden and Steel Profile doors</b>							
	9227863	9227863	Top & Bottom Pivot for Wooden and Profile doors (For door weight up to 150 kg)	1	Set	1	1,623	83024110
	<b>Floor pivot/ Hinge</b>							
	9250826	9250826	Floor pivot/hinge with loading capacity of 150 Kg doors	1	Set	1	1,692	83024110

Note: Please refer Architectural Hardware Exclusive Price List for all available solutions

# Glass Patch Fittings

► Glass Patch Fittings



Product	Article No.	SAP	Item Description	Qty.	Unit	PU	MRP	HS Code
<b>Glass Patch Fittings (SS 304 satin finish cover; For 8–12 mm Glass thickness)</b>								
<b>Bottom Patch</b>								
 	9228265	9228265	HGF 100 : Bottom Patch	1	Set	1	1,207	83024110
<b>Top Patch</b>								
 	9228266	9228266	HGF 200 : Top Patch	1	Set	1	1,207	83024110
<b>Overpanel side Patch</b>								
 	9228268	9228268	HGF 400 : Overpanel side Patch	1	Set	1	1,982	83024110
<b>Overpanel Patch with Fixing Plate</b>								
 	9228275	9228275	HGF 930 : Overpanel Patch with Fixing Plate	1	Set	1	1,188	83024110
<b>Connector for over panel</b>								
 	9228276	9228276	HGF 940: Connector for over panel	1	Set	1	1,627	83024110
<b>Corner Patch lock</b>								
 	9228269	9228269	HGF 500 : Corner Patch lock	1	Set	1	1,872	83024110
	9228171	9228171	HSCL 60: Both side key 60 mm, for max door thickness – 40 mm (Please order Euro Profile cylinder 60 mm separately)	1	Set	1	1,464	83024110
<b>Top pivot for Top patch</b>								
	9228458	9228458	HGF 800: Fixed top pivot for top patch	1	Set	1	371	83024110







Note: Please refer Architectural Hardware Exclusive Price List for all available solutions









Product	Article No.	SAP	Item Description	Qty.	Unit	PU	MRP	HS Code
	HPH 2110 Back to Back Handles Dia: 25 mm (Wooden Door thickness : 30-60 mm & Glass thickness : 8-12 mm)							
	9228527	9228527	HPH 2110 : Back to Back Pull Handles Dia. 19mm, CTC Length 200mm, SS Finish	1	Set	1	1,485	83024190
	9228529	9228529	HPH 2110 : Back to Back Pull Handles Dia. 25mm, CTC Length 300mm, SS Finish	1	Set	1	1,958	83024110
	HPH 2330 Back To Back Pull Handles Dia: 25 mm (Wooden Door thickness : 30-60 mm & Glass thickness : 8-12 mm)							
	9228549	9228549	HPH 2330: Back to Back Pull Handles Dia. 25mm, CTC Length 300, SS Finish O/A 400	1	Set	1	2,094	83024110
	9228551	9228551	HPH 2330: Back to Back Pull Handles Dia. 25mm, CTC Length 400, SS Finish O/A 550	1	Set	1	2,564	83024110









Note: Please refer Architectural Hardware Exclusive Price List for all available solutions

Product	Article No.	SAP	Item Description	Qty.	Unit	PU	MRP	HS Code
	<b>Drop Seal : HDS D1 (For Wooden Door)</b>							
	9250604	9250604	HSDS1-850 : For timber doors, 650-850 mm door width	1	Set	1	1,294	83021090
	9250605	9250605	HSDS1-1000: For timber doors, 850-1000 mm door width	1	Set	1	1,371	83021090
	9250606	9250606	HSDS1-1200: For timber doors, 1000-1200 mm door width	1	Set	1	1,523	83021090
	<b>Flush Bolt for timber doors</b>							
	9228397	9228397	HFB 1: Flush bolt for Timber Door (200 mm)	1	Pc	1	674	83024110
	9228424	9228424	HFB 1: Flush bolt for Timber Door (300 mm)	1	Pc	1	828	83024110
	<b>Flush Bolt for Metal doors</b>							
	9228398	9228398	HFB 2: Flush bolt for Metal Doors	1	Set	1	812	83024110
	<b>Automatic Flush Bolt</b>							
	9228400	9228400	HFB 4: Automatic Flush Bolt	1	Pc	1	1,125	83024110
	<b>Dust Proof Socket</b>							
	9228401	9228401	HFBA1: Dust Proof Socket for flush bolt	1	Pc	1	342	83024110
<b>Magnetic Wall Stop</b>								
	<b>HWS75</b>							
	9228402	9228402	HWS 75: Magnetic Wall Stop	1	Set	1	1,490	83024110
	<b>HWS 45</b>							
	9228707	9228707	HWS 45: Magnetic Wall Stop	1	Set	1	1,013	83024110

Note: Please refer Architectural Hardware Exclusive Price List for all available solutions

Product	Article No.	SAP	Item Description	Qty.	Unit	PU	MRP	HS Code
	<b>Pull Plate</b>							
	9228403	9228403	HPP 1: Pull plate	1	Pc	1	940	83024190
	<b>Push Plate</b>							
	9228404	9228404	HPP2: Push Plate for Door	1	Pc	1	553	83024110
<b>Door Chain/Guard</b>								
	<b>Door Chain</b>							
	9228405	9228405	HDC 1: Door Chain	1	Pc	1	1,087	83024110
	<b>Door Guard</b>							
	9228708	9228708	HDC 2: Door Guard	1	Pc	1	1,259	83024110
<b>Door Stopper</b>								
	<b>Door Stopper Floor Mounted</b>							
	9228407	9228407	HDS 44: Door Stopper	1	Pc	1	352	83024110
	<b>Door Stopper Floor Mounted</b>							
	9228408	9228408	HDS 45: Door Stopper	1	Pc	1	467	83024110

Note: Please refer Architectural Hardware Exclusive Price List for all available solutions

Product	Article No.	SAP	Item Description	Qty.	Unit	PU	MRP	HS Code
	<b>Door Drop Stop</b>							
	9228709	9228709	HDS 46: Door Drop Stop	1	Pc	1	841	83024110
	<b>Door Drop Stop</b>							
	9228710	9228710	HDS 47: Door Drop Stop	1	Pc	1	1,384	83024110
	<b>Door Stopper Wall Mounted</b>							
	9250600	9250600	HWS 76: Wall Stop	1	Pc	1	345	83024110
<b>Door Viewer</b>								
	<b>Door Viewer</b>							
	9228410	9228410	HDV 1: Door viewer 180° view (for door thick-35- 55mm)	1	Pc	1	1,042	83024110
	<b>Door Viewer</b>							
	9228439	9228439	HDV 2: Door viewer 140° view (for door thickness 35-55mm)	1	Pc	1	575	83024110
	9250664	9250664	HDV 2: Door viewer 140° view (for door thickness 35-60mm)	1	Pc	1	575	83024110
	<b>Catalogue</b>							
	9254294	9254294	Architectural Hardware & Applications Catalogue	1	Pc	1	On Request Only	

Note: Please refer Architectural Hardware Exclusive Price List for all available solutions



\* Refer Website

**Warranty Clause**

For Warranty Regarding Architectural Hardware please refer to below site.  
[www.hettich.com/in](http://www.hettich.com/in)

	Conformité Européenne, meaning "European Conformity"
	European Norm for Fire Protection Certification for Hardware
	European Norm for Door Closing Devices
	European Norm for Door Coordinator Devices
	European Norm for Lever Handles & Knob Furniture
	European Norm for Emergency Exit Locks with Door Handles
	European Norm for Panic Exit Devices
	European Norm for Mechanically Operated Locks, Latches & Locking Plates
	European Norm for Euro Profile Cylinders for Mortise Locks
	European Norm for Hinges

EN STANDARDS		
EN Value	Recommended Door Width (MM)	Recommended Door Weight (KG)
EN 1	750	20
EN 2	850	40
EN 3	950	60
EN 4	1100	80
EN 5	1250	100
EN 6	1400	120
EN 7	1600	160



## 3D Adjustment Hinges Installation: Precautions

Things to be remember while Installing 3D Concealed Hinge

- Alignment of the door should be perfectly at 90 degree from floor
- The adjusted door weight to be calculated according to door weight calculation sheet.
- Door dimensions: Door Width: Max 1000 mm Door Height: Max 2400 mm Door Thickness: Max 60 mm
- 3 Nos of hinges are more than enough for doors of adjusted door weight\* up to 135 kg

Note:- No more than 3 hinges to be suggested per door \*Please calculate adjusted door weight explained on page no.138

## Weight to Width Ratio Graph

Graph shows weight to width ratio for door without door closer with max 3 Nos of hinges

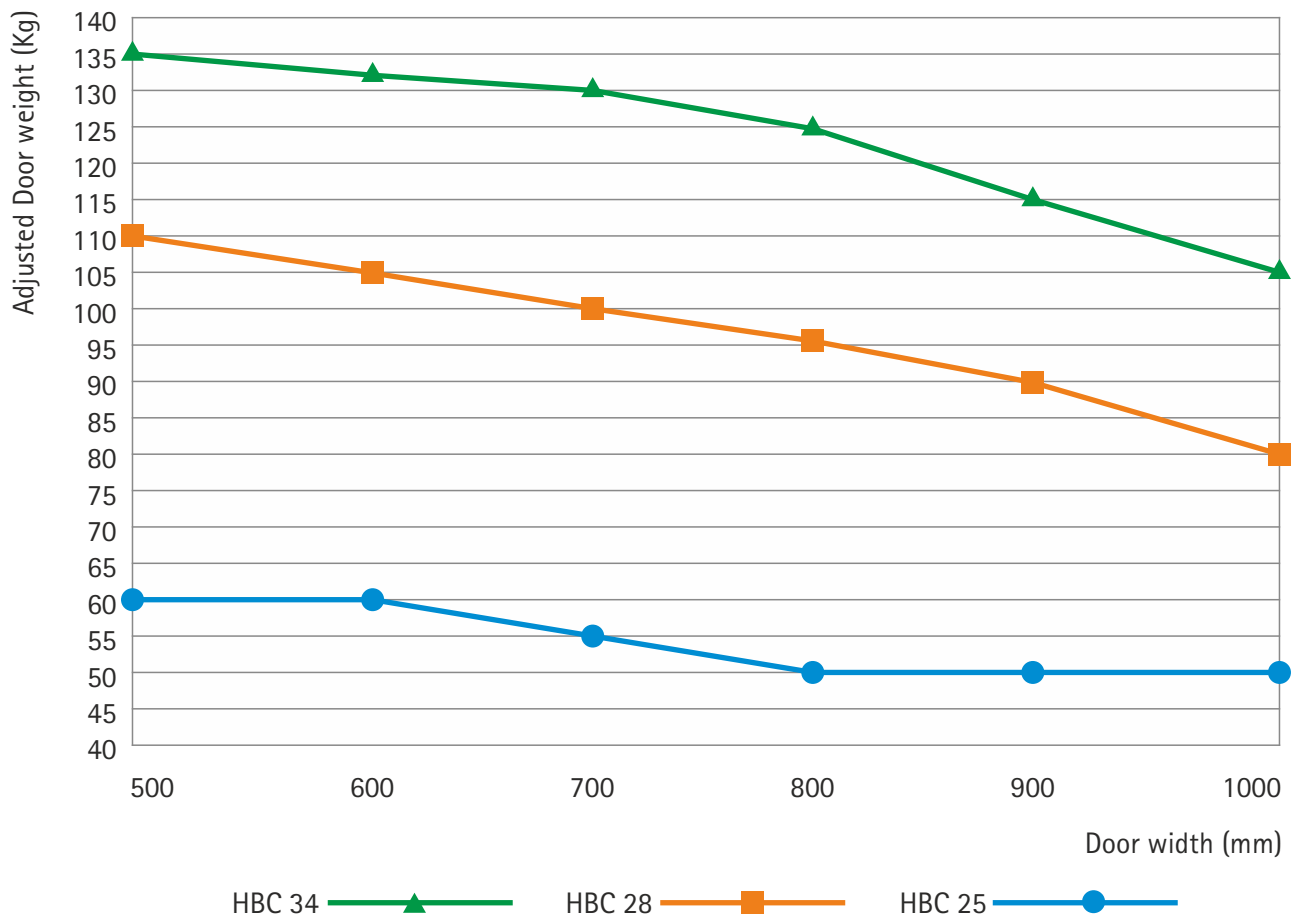

Graph

## Hinge Position: Diagram

Below are two options for hinges installation:

Installation of the top & bottom hinges first followed by the third hinge according to drawing.

Note: The two hinges at the top carries the major portion of door weight while the bottom hinge completes the door axis

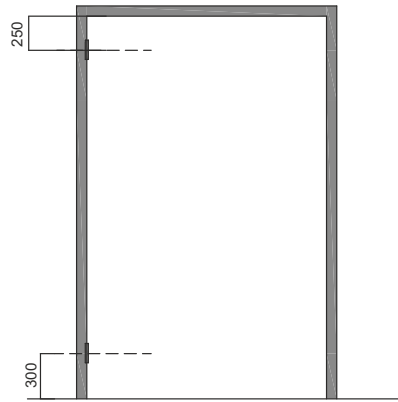

**Fig. 1**  
2 hinges per door

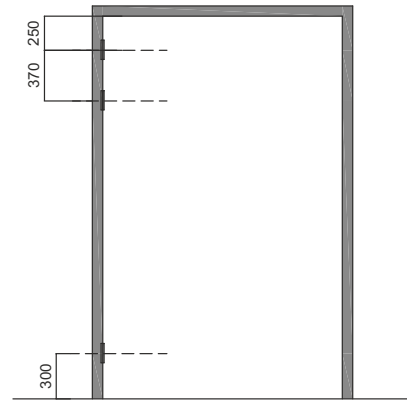
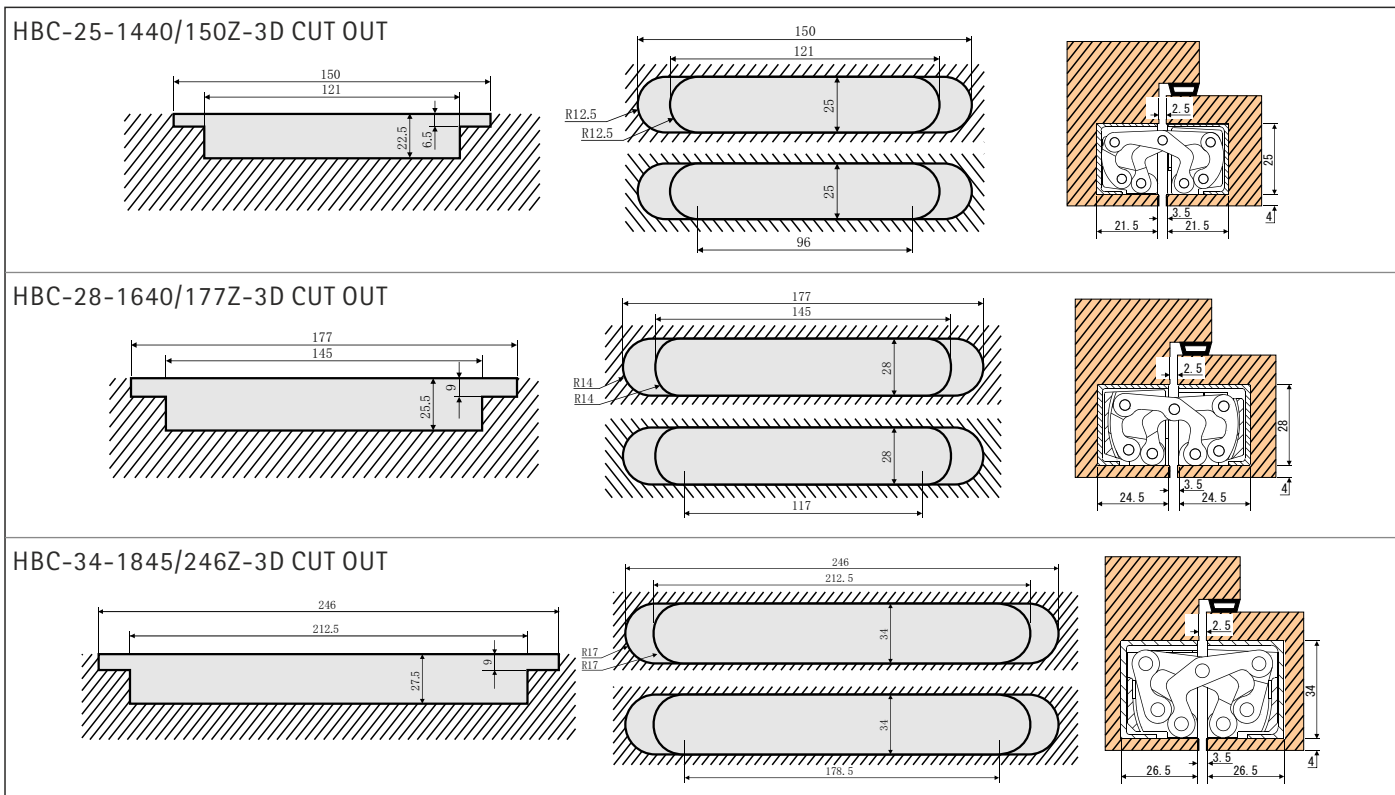

**Fig. 2**  
3 hinges per door

## Door Milling Drawings

Please make sure the door cutouts to be made are as per door milling diagrams

Note: Manual cutting may sometimes lead to misalignment and misalignments may hamper the performance of the hinge



## Value-Added Services

Services that make planning, buying & installation experiences delightful



### Free Design Service

Looking for designs to liven up your living room, bedroom, bathroom or kitchen? A dedicated team of highly qualified Interior Designers are at service to provide customized design solutions to suit your individual tastes and budgets, completely free of cost.



### Free Consultation at Doorsteps

Looking for perfect Furniture Fitting solutions? A dedicated team of highly qualified professionals will provide expert solutions to suit your need and budget right at your doorstep, completely free of cost.



### Hettich Customer Care Service

Hettich, being a customer-centric organisation constantly endeavours to provide best quality products and services. Our representative are groomed to be ever-responsive to customer queries & complaints.



### Application Centres

Application Centre is a pioneering concept by Hettich to serve as a one-stop destination to design possibilities for residences and commercial spaces. One can experience how cutting-edge Hettich fittings can transform spaces into smart, space-efficient and aesthetically appealing units. Hettich Application Centres are located across all major cities in India.



### Design Gallery App

Riding on the megatrend of digitization, the Design Gallery App allows customers to explore endless design possibilities using Hettich solutions for their living spaces at the touch of a button.





YOUR PARTNER. YOUR INSPIRER.  
YOUR NETWORKER.

IT'S ALL IN  
HETTICH



A series of horizontal dotted lines spanning the width of the page, intended for taking notes.





**Registered & Head Office:****Hettich India Private Limited**

302, Durolite House,  
Opp. SAB TV, New Link Road,  
Andheri (West), Mumbai - 400 053  
Phone: +91 22 2674 3289/3356/4089

**Delhi Office:****Hettich India Private Limited**

A-26/4, 1st floor,  
Mohan Co-operative Industrial Estate,  
New Delhi - 110 044  
Phone: +91 11 4889 4000, 4889 4005

**Production Site – Vadodara:****Hettich India Private Limited**

Plot No. 304, Dhanora,  
Nandesari Road,  
Near ECPL,  
Village – Dhanora – 391 346  
Dist. – Vadodara, Gujarat

**Production Site – Indore:****Hettich India Private Limited**

Plot No 1, Sector 5,  
Mhow – Neemuch Road,  
Opp Lupin Ltd, Pithampur Industrial,  
Pithampur – 454 774  
Madhya Pradesh

**Application Centres:****Bengaluru:**

Adventz Center, Ground Floor 28,  
Cubbon Road, Shivaji Nagar,  
Bengaluru - 560 001  
Ph. No. : +91 91 3601 6413

**Mumbai:**

202/302, Durolite House, Opp. SAB TV,  
New Link Road, Andheri (West),  
Mumbai - 400 053  
Ph.No. : +91 22 2639 9707

**New Delhi:**

61, Punchkuian Road,  
Near RK Ashram Metro,  
Opposite Pillar No 4,  
New Delhi -110001,  
Ph. No. : +91 11 4750 8320

**Chennai:**

"Heavitree", Ground Floor,  
47, Spur Tank Road,  
Chetpet, Chennai - 600 031  
Ph. No. : +91 44 4263 7227

**Ahmedabad:**

1st Floor, Unit No. 102,  
Safal Pegasus, Anand Nagar,  
Ahmedabad - 380 015,  
Ph. No. : +91 79 4032 2824  
+91 84 4838 5318

**Gurugram:**

Global Business Park, Tower – A, 5th Floor,  
Mehrauli-Gurgaon Rd, Sikanderpur,  
Sector 26, Gurugram, Haryana 122 002.  
Ph. No. : +91 124 4221670

**Hyderabad:**

"Sai Krishna"  
797 – A, 2nd Floor,  
Road No. 36, Jubilee Hills,  
Hyderabad - 500 034  
Ph. No. : +91 40 2355 8994

**Indore:**

Office No.106 and 107-A,  
"Brilliant Titanium",  
Plot No.9, Scheme No.78, Part-II,  
Indore - 452 010  
Ph. No. : +91 96 9168 4480

**Chandigarh:**

2nd Floor, Aspire Tower, Plot no. 55,  
Industrial & Business park, Phase 1,  
Chandigarh - 160 002  
Ph. No. : +91 172 5012 347

**Kochi:**

41/2062D, 2nd Floor  
Palarivattom signal  
junction, NH 47 By-pass,  
Kochi - 682 028  
Ph. No. : +91 48 4402 8242

**Pune:**

Server Spacer ,  
Survey No. 127/1A ,  
Plot No. 8, Off. ITI Road, Aundh,  
Pune - 411 007  
Ph. No : +91 72 0847 6557

**Kolkata:**

2nd Floor, Unit Number 2A,  
Tirumala 22, East Topsia Road,  
At Topsia Tangra Crossing  
Kolkata - 700 046  
Ph. No. : +91 98310 12054

**Enquiry & Customer Services**

Toll Free : 1800 209 2096 (office hours)  
Email: sales\_enquiry@in.hettich.com  
customer\_services@in.hettich.com  
[www.hettich.com](http://www.hettich.com)

**Training Centre Address:**

Hettich Poddar Wood Work Institute  
Plot No.2, 1st Floor, DLF Industrial Estate-1  
Near NHPC Metro Station,  
Faridabad- Haryana  
Ph: +91 129 4203888  
Email: info@hpwwi.com

Follow Hettich India

